

Load **LIFTER** 5000™ **ULTIMATE**

ADJUSTABLE AIR HELPER SPRINGS

TOW AND HAUL WITH SAFETY AND COMFORT™



Kit Number
88349

INSTALLATION GUIDE

For maximum effectiveness and safety, please read these instructions completely before proceeding with installation.

Failure to read these instructions can result in an incorrect installation.

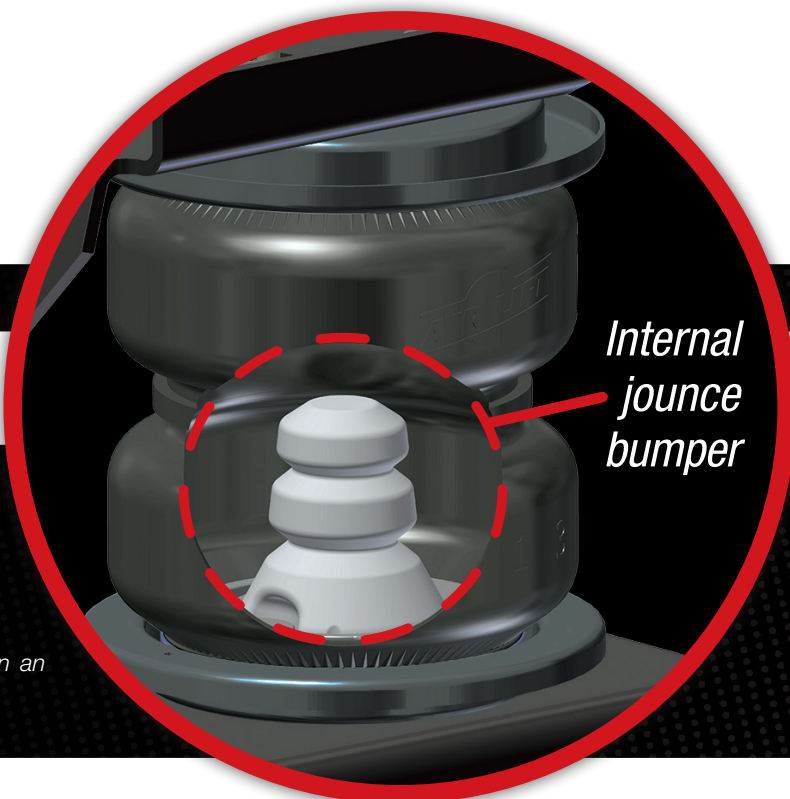

TABLE OF CONTENTS

Introduction	2
Important Safety Notice	2
Notation Explanation	2
Installation Diagram	3
Hardware List	4
Tools List	4
Installing the LoadLifter 5000 Ultimate System	5
Getting Started	5
Assembling the Air Spring Assemblies	7
Installing the Assemblies	11
Installing the Heat Shield	13
Installing the Air Lines	14
Finished Installation Photos	16
Checking for Leaks	17
Fixing Leaks	17
Before Operating	18
Installation Checklist	18
Post-Installation Checklist	18
Product Use, Maintenance and Servicing	19
Minimum and Maximum Pressure	19
Maintenance Guidelines	19
Troubleshooting Guide	19
Frequently Asked Questions	20
Tuning the Air Pressure	20
Guidelines for Adding Air	21
Choosing the Right On-Board Air Compressor System	22
Warranty and Returns Policy	23
Replacement Information	24
Contact Information	24

Introduction

The purpose of this publication is to assist with the installation, maintenance and troubleshooting of the LoadLifter 5000 Ultimate air spring kit. LoadLifter 5000 Ultimate utilizes sturdy, reinforced, commercial grade single- or double-bellows (depending on the kit). The bellows are manufactured like a tire with layers of rubber and cords that control growth. An internal jounce bumper inside the spring absorbs shock and eliminates harsh jarring on rough roads. The internal jounce bumper replaces the factory bumper and allows the air springs to safely be run at zero air pressure. LoadLifter 5000 Ultimate kits are recommended for most 3/4 and 1 ton pickups and SUVs with leaf springs, and provide up to 5,000 pounds of load-leveling support with air adjustability from 5-100 PSI. The kits are also used in motorhome rear kits and some motorhome fronts where leaf springs are used.

It is important to read and understand the entire installation guide before beginning installation or performing any maintenance, service or repair. The information here includes a hardware list, tool list, step-by-step installation information, maintenance tips, safety information and a troubleshooting guide.

Air Lift Company reserves the right to make changes and improvements to its products and publications at any time. For the latest version of this manual, contact Air Lift Company at (800) 248-0892 or visit our website at www.airliftcompany.com.

IMPORTANT SAFETY NOTICE

The installation of this kit does not alter the Gross Vehicle Weight Rating (GVWR) or payload of the vehicle. Check your vehicle's owner's manual and do not exceed the maximum load listed for your vehicle.

Gross Vehicle Weight Rating: The maximum allowable weight of the fully loaded vehicle (including passengers and cargo). This number — along with other weight limits, as well as tire, rim size and inflation pressure data — is shown on the vehicle's Safety Compliance Certification Label.

Payload: The combined, maximum allowable weight of cargo and passengers that the vehicle is designed to carry. Payload is GVWR minus the Base Curb Weight.

NOTATION EXPLANATION

Hazard notations appear in various locations in this publication. Information which is highlighted by one of these notations must be observed to help minimize risk of personal injury or possible improper installation which may render the vehicle unsafe. Notes are used to help emphasize areas of procedural importance and provide helpful suggestions. The following definitions explain the use of these notations as they appear throughout this guide.

**DANGER**

INDICATES IMMEDIATE HAZARDS WHICH WILL RESULT IN SEVERE PERSONAL INJURY OR DEATH.

**WARNING**

INDICATES HAZARDS OR UNSAFE PRACTICES WHICH COULD RESULT IN SEVERE PERSONAL INJURY OR DEATH.

**CAUTION**

INDICATES HAZARDS OR UNSAFE PRACTICES WHICH COULD RESULT IN DAMAGE TO THE MACHINE OR MINOR PERSONAL INJURY.

NOTE

Indicates a procedure, practice or hint which is important to highlight.

Installation Diagram

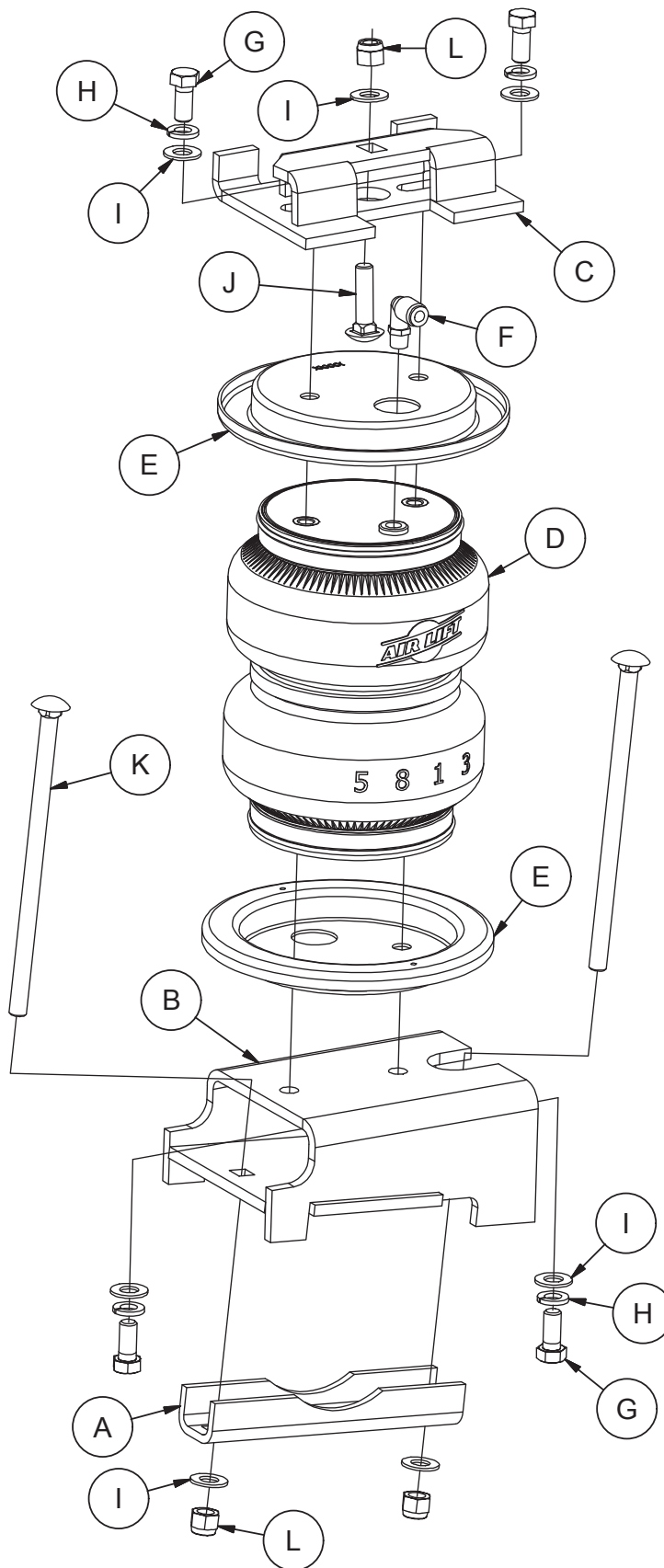

fig. 1



HARDWARE LIST

Item	Part #	Description.....Qty	Item	Part #	Description.....Qty
A	01531	Clamp bar2	AA*	20086	Air line assembly 1
B	03108	Lower bracket2	BB*	10466	Tie strap6
C	07984	Upper bracket2	CC*	21230	Valve cap2
D	58496	Air spring2	DD*	18501	5/16" flat washer2
E	11967	Roll plate4	EE*	21234	Rubber washer.....2
F	21837	90° swivel fitting2	FF*	18411	Star washer.....2
G	17203	3/8"-24 x 7/8" hex head bolt.....8	GG*	21233	5/16" hex nut.....4
H	18427	3/8" lock washer8			
I	18444	3/8" flat washer 14	*Not shown in fig. 1.		
J	17156	3/8"-16 x 1.5" long carriage bolt.....2			
K	17163	3/8"-16 x 7.0" long carriage bolt.....4			
L	18435	3/8"-16 nyloc nut6			



Missing or damaged parts? Call Air Lift customer service at (800) 248-0892 for a replacement part.

TOOLS LIST

Description..... Qty	Description..... Qty
Hoist or floor jacks 1	Metric and standard sockets..... 1
Safety stands..... 2	5/16" drill bits (very sharp) 1
Safety glasses 1	Heavy duty drill..... 1
Torque wrench..... 1	Hose cutter, razor blade, or sharp knife 1
Standard open-end combo wrenches..... 1	Air compressor or compressed air source..... 1
Ratchet 1	Spray bottle with dish soap/water solution 1

Installing the LoadLifter 5000 Ultimate System

GETTING STARTED

DANGER

COMPRESSED AIR CAN CAUSE INJURY AND DAMAGE TO THE VEHICLE AND PARTS IF IT IS NOT HANDLED PROPERLY. FOR YOUR SAFETY, DO NOT TRY TO INFLATE THE AIR SPRINGS UNTIL THEY HAVE BEEN PROPERLY SECURED TO THE VEHICLE.

1. Raise the vehicle and support it in some way, using jack stands or equivalent, so that the axle can be dropped safely away from the frame. This will need to be done in order for the air spring assembly to be put into position between the axle and frame (fig. 2). Figure 2 shows the frame being supported with the vehicle on a drive on hoist.



fig. 2

2. In order to install the kit, it will be necessary to remove the stock jounce bumpers and mounting brackets from under the frame rails on both sides of the vehicle (fig. 3).



fig. 3

3. It will be necessary to temporarily remove the vent/brake line junction block on the driver side from the axle bracket (fig. 4). Do this by pulling the clip off the front side of the junction block and pull it back to remove it from the bracket.



fig. 4

4. Remove the bolt from the brake line bracket that is attached to the spring perch (fig. 5).



fig. 5

5. Unclip the brake line from the bracket on top of the differential (fig. 6).



fig. 6

6. Pull the brake line back away from the axle to make room for placing the air spring assembly, on the driver side, into position (fig. 7).



fig. 7

ASSEMBLING THE AIR SPRING ASSEMBLIES

1. Set a roll plate (E) on top of the air spring (D). The radiused or rounded edge of the roll plate will be towards the air spring so that it is seated inside the roll plate (fig. 8). Install the 90° swivel fitting (F) into the top of the air spring, finger tight plus one and a half turns.

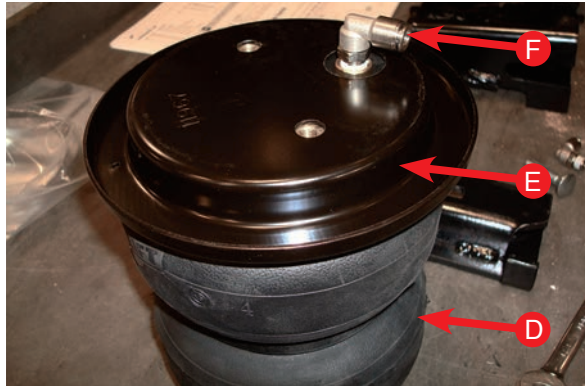

fig. 8

2. Insert the 3/8-16 X 1.5" carriage bolts (J) through both upper brackets (C) as shown (fig. 9).

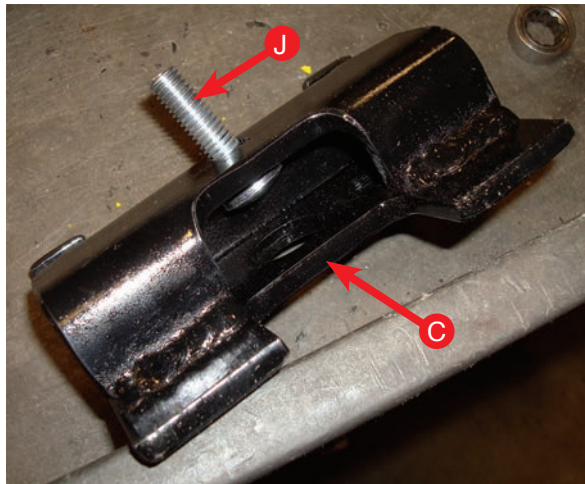

fig. 9

3. Set the brackets on both air spring assemblies and attach with 3/8-16 X 7/8" hex cap screws (G), 3/8" lock washers (H) and 3/8" flat washers (I). Leave loose at this time (fig. 10). Figure 11 shows the upper air spring assembly.

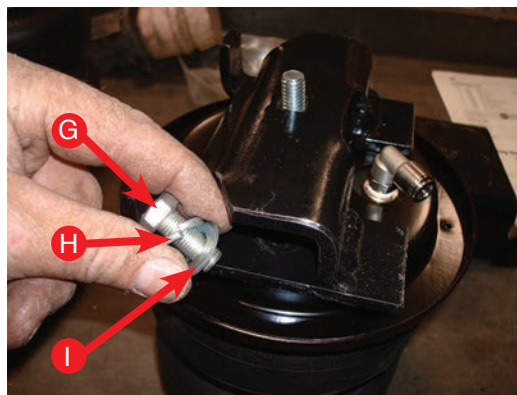

fig. 10



fig. 11

4. Flip the air spring assemblies upside down and set a roll plate (E) over the bottom of each air spring (fig. 12). The radiused or rounded edge of the roll plate will be towards the air spring so that the air spring is seated inside the roll plate.



fig. 12

5. Insert the 3/8-16 X 7" carriage bolts (K) through the lower bracket (B) hole that is opposite of the slot shown in figure 13. Repeat for both lower brackets.

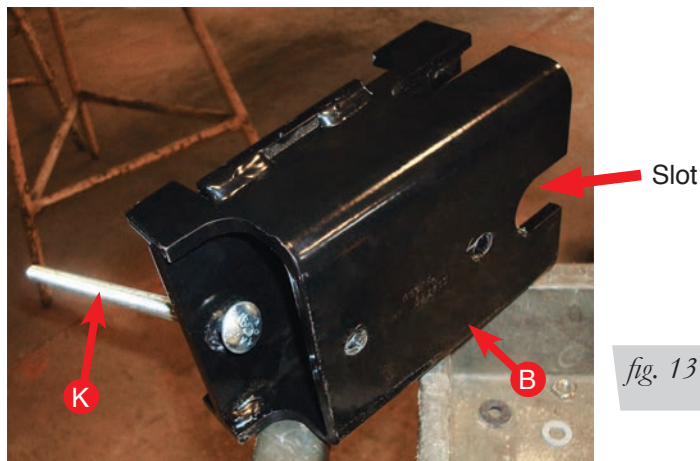

fig. 13

- When setting the lower bracket onto the air spring assemblies, you will be setting up both a left and a right hand assembly. Assemble the right hand (passenger) assembly as shown in figure 14. Assemble the left (driver) side air spring assembly by rotating the air spring assembly 180°.

NOTE

The slot in the lower bracket will face the rear of the vehicle and the fittings will be to the outside of the frame when installed onto the vehicle.

The Right (Passenger) side is shown.

Rotate the air spring assembly 180° to create the left (driver) side assembly.

The flange on the upper bracket will be to your left.

The fitting should be pointing to your right.

Slot in lower bracket will be pointed towards you.

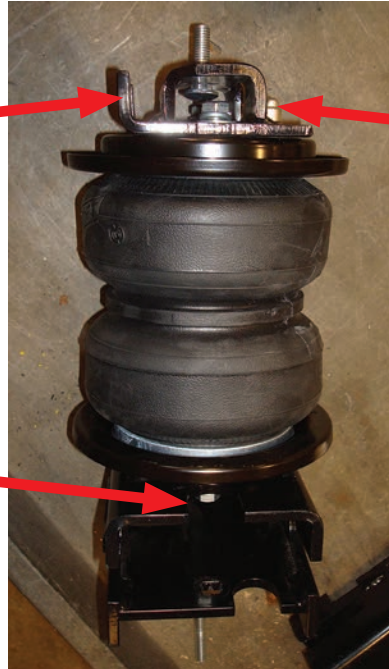

fig. 14

- Attach the lower bracket (B) to the air spring assemblies with the 3/8-16 X 7/8" hex cap screws (G), 3/8" lock washers (H) and 3/8" flat washer (I) and tighten to no more than 20 ft-lbs. (fig. 15).

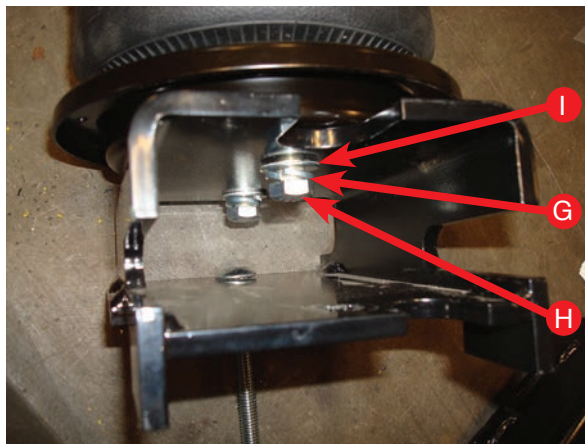

fig. 15

- The upper bracket (C) has two slots for mounting to the air spring and will be specific to which side the assembly is mounted. Figure 16 shows the upper bracket and the correct holes to use for the left (driver) and right (passenger) side installations. Torque the mounting hardware to no more than 20ft-lbs.

NOTE

With the assembly put into position on the axle, the bracket must be forward of the air spring, fully in the slot. The mounting bolts will be to the rear of the assembly.

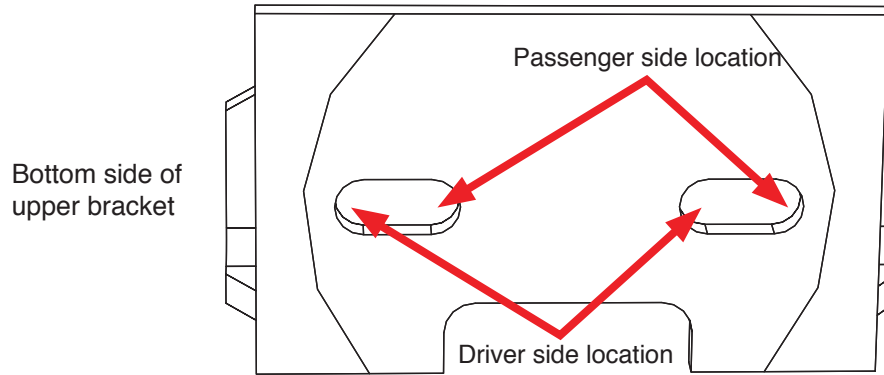

fig. 16

- Figure 17 shows the completed left (driver) and right (passenger) side assemblies.



Note the upper mounting bolts to the rear of the slots in the upper brackets on the assemblies.

fig. 17

Left (Driver) side assembly

Right (Passenger) side assembly

INSTALLING THE ASSEMBLIES

1. Set the left and right hand assemblies onto the axle. Make sure the brake line that was un-bolted on the left (driver) side is clear while positioning the assembly. Raise the axle or lower the frame so that the upper bracket carriage bolts go through the existing jounce bumper holes in the bottom of the frame. Also, make sure that the flanges on the upper bracket fit on the inside of the lower frame flange (Figs. 18 and 19).

The fitting is facing toward the outside of the vehicle frame

Make sure brake line is clear when positioning assembly into position on driver side.

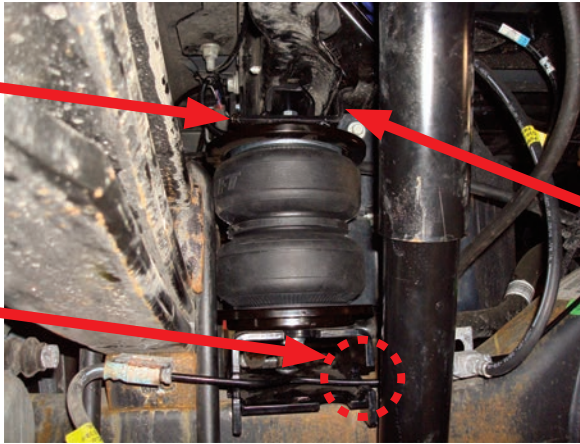

Left (Driver) side shown

Make sure the flange on the upper bracket is on the inside of the lower frame flange as shown.

fig. 18

2. Cap the upper bracket's 3/8-16 X 1.5" Carriage bolts (J) with a 3/8" Flat washer (I) and 3/8-16 Nylon Lock Nut (L). Push the flange of the upper bracket outboard (against the frame) as far as it will go and torque the upper mounting hardware to 15ft-lbs. (fig. 19). Repeat for the opposite side.

Vehicle frame

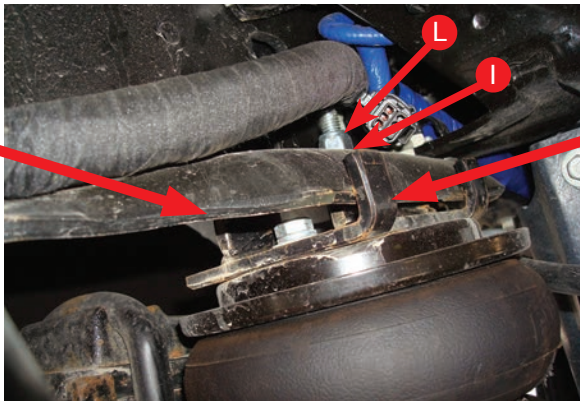

Upper bracket

fig. 19

3. Insert the last two 3/8 -16 X 7" Carriage Bolts (K) into the last holes in the lower bracket behind the axle. Make sure the passenger side goes on the outside of the hard brake line as shown in figure 20.

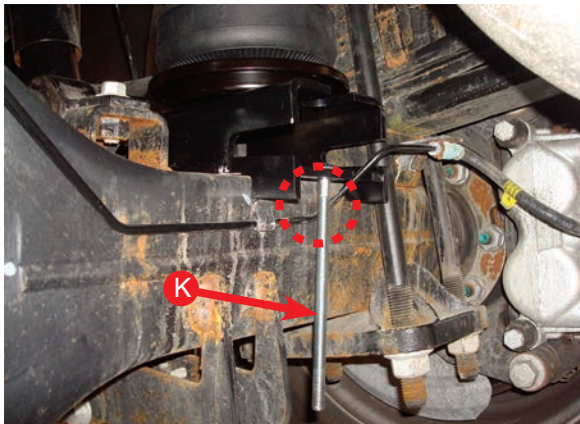

Right (Passenger) side shown

fig. 20

- Adjust the lower bracket/air spring assembly in and out on the axle to align the air spring as perpendicular to the upper bracket as possible. Install the Clamp Bar (A) over the long carriage bolts previously installed and cap with two 3/8" Flat Washers (I) and two 3/8-16 Nylon Lock Nuts (L) (fig. 21). Torque both nuts evenly to 15ftlbs. Repeat for the other side.

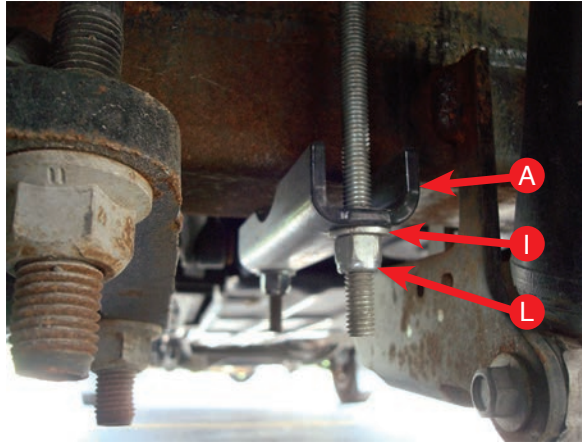
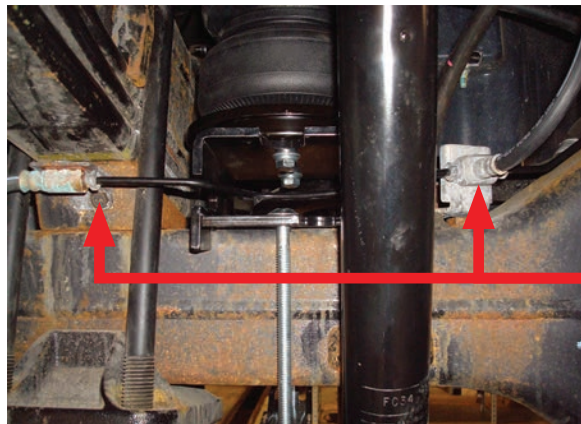

fig. 21

- Once the upper and lower brackets are tight, re-connect the brake line bracket to the spring perch using the stock bolt removed. Insert the brake line junction block back into the bracket on the axle and re-insert the clip that holds it in place. Clip the brake line back onto the bracket on top of the differential that was previously removed (figs. 6 and 22).



Re-attach the brake line brackets and holders back into position on the driver side that was previously

fig. 22

- The lower brackets have recesses in them to make clearance for the hard brake lines (figs. 23 and 24). If necessary, adjust the brake line so it is not rubbing on the lower bracket.

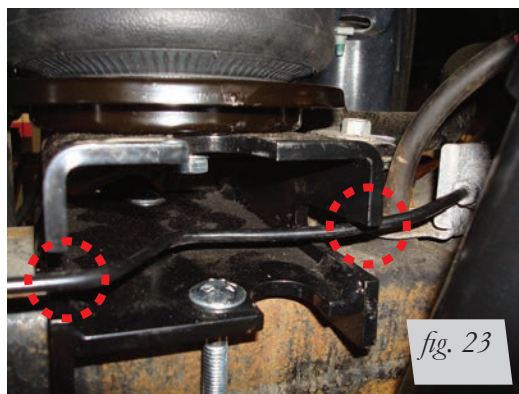

fig. 23

Hard brake line must not rub against the lower bracket as shown.

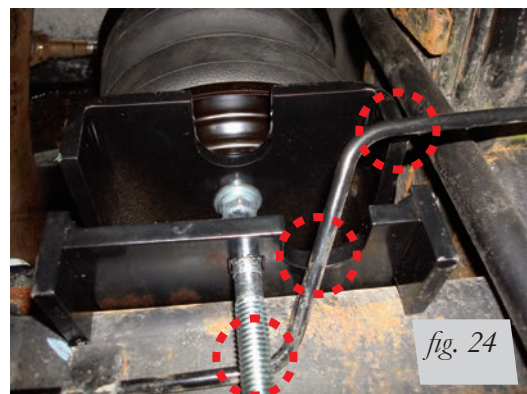
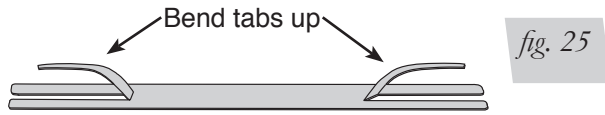

fig. 24

Hard brake line must not rub against the lower bracket or carriage bolt as shown.

INSTALLING THE HEAT SHIELD

1. Bend the tabs on the heat shield to provide a 1/2" dead air space between exhaust pipe and heat shield (fig. 25).



2. Attach the heat shield to the exhaust pipe using the clamps (fig. 26). Bend the heat shield for maximum clearance to the air spring.

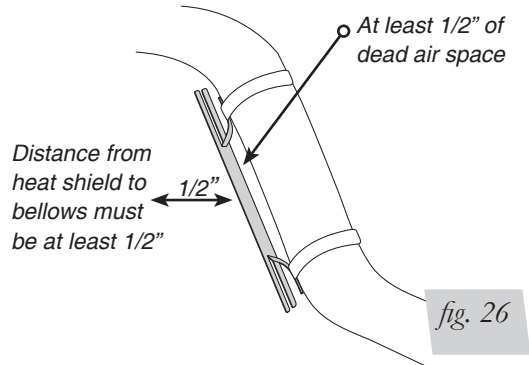

3. For vehicles with the large resonator on the rear exhaust, in order for the heat shield to be clamped onto the resonator, it will be necessary to double up on the clamps so they can go around it (fig. 27).



4. Once the tabs are bent correctly, attach the heat shield to the resonator or exhaust pipe as shown in figure 28.



INSTALLING THE AIR LINES

1. Choose a convenient location for mounting the inflation valves. Popular locations for the inflation valve are:
 - a. The wheel well flanges.
 - b. License plate recess in bumper.
 - c. Under the gas cap access door.
 - d. Through license plate itself.

NOTE

What ever the chosen location is, make sure there is enough clearance around the inflation valves for an air chuck.

2. Drill a 5/16" hole to install the inflation valves.
3. Cut the air line assembly (AA) in two equal lengths.

CAUTION

WHEN CUTTING OR TRIMMING THE AIR LINE, USE A HOSE CUTTER, A RAZOR BLADE OR A SHARP KNIFE. A CLEAN, SQUARE CUT WILL PREVENT LEAKS. DO NOT USE WIRE CUTTERS OR SCISSORS TO CUT THE AIR LINE. THESE TOOLS MAY FLATTEN OR CRIMP THE AIR LINE, CAUSING IT TO LEAK AROUND THE O-RING SEAL INSIDE THE ELBOW FITTING (FIG. 29)

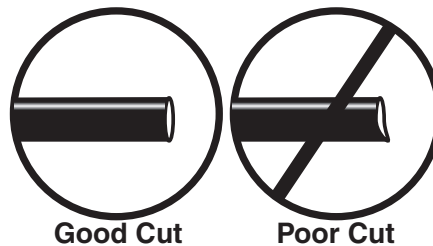

fig. 29

4. Place a 5/16" nut (GG) and a star washer (FF) on the air valve. Leave enough of the inflation valve in front of the nut to extend through the hole and have room for the rubber washer (EE), flat washer (DD), and 5/16" nut (GG) and cap (CC). There should be enough valve exposed after installation - approximately 1/2" - to easily apply a pressure gauge or an air chuck (fig. 30).
5. Push the inflation valve through the hole and use the rubber washer (EE), flat washer (DD), and another 5/16" nut (GG). Tighten the nuts to secure the assembly in place (fig. 30).

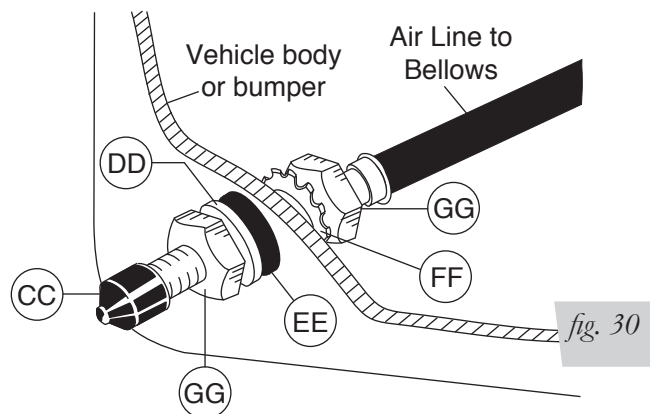
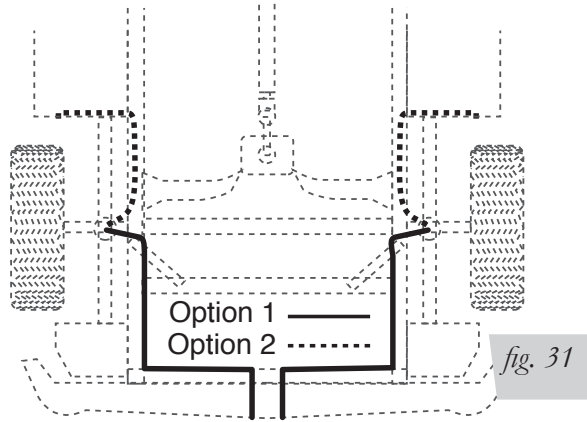

fig. 30

6. Route the air line along the frame to the air fitting on the air spring (fig. 31). Keep AT LEAST 6" of clearance between the air line and heat sources, such as the exhaust pipes, muffler, or catalytic converter. Avoid sharp bends and edges. Use the plastic tie straps (BB) to secure the air line to fixed, non-moving points along the chassis. Be sure that the tie straps are tight, but do not pinch the air line. Leave at least 2" of slack to allow for any movement that might pull on the air line.



7. Cut off the air line leaving approximately 12" of extra air line. A clean square cut will prevent leaks (see fig. 29). Insert the air line into the air fitting. This is a push to connect fitting. Simply push the air line into the 90° swivel fitting until it bottoms out (9/16" of air line should be in the fitting).

FINISHED INSTALLATION PHOTOS

1. Figure 32 shows the rear view of the left (driver) side.



fig. 32

2. Figure 33 shows the inside, above axle view of the right (passenger) side installation.



fig. 33

3. Figure 34 shows the rear view of the right (passenger) side installation.



fig. 34

4. Figure 35 shows an inside view of the left (driver) side installation.



fig.35

CHECKING FOR LEAKS

1. Inflate the air spring to 30 PSI and spray all connections and the inflation valves with a solution of 1/5 liquid dish soap and 4/5 water to check for leaks. Spot leaks easily by looking for bubbles in the soapy water.
2. After the test, deflate the springs to the minimum pressure required to restore the normal ride height, no less than 5 PSI.
3. Check the air pressure again after 24 hours. A 2-4 PSI loss after initial installation is normal. Retest for leaks if the loss is more than 5 lbs.

FIXING LEAKS

1. If there is a problem with the swivel fitting:
 - a. Check the air line connection by deflating the spring and removing the line by pulling the collar against the fitting and pulling firmly on the air line. Trim 1" off the end of the air line. Be sure the cut is clean and square (see fig. 29). Reinsert the air line into the push-to-connect fitting.
 - b. Check the threaded connection by tightening the swivel fitting another 1/2 turn. If it still leaks, deflate the air spring, remove the fitting, and re-coat the threads with thread sealant. Reinstall by hand tightening as much as possible, then use a wrench for an additional two turns.
2. If there is a problem with the inflation valve, then:
 - a. Check the valve core by tightening it with a valve core tool.
 - b. Check the air line connection by removing the air line from the barbed type fitting.

CAUTION

DO NOT CUT THE AIR LINE COMPLETELY OFF AS THIS WILL NICK THE BARB AND RENDER THE FITTING USELESS.

3. If the preceding steps have not resolved the problem, call Air Lift customer service at (800) 248-0892 for assistance.

Before Operating

INSTALLATION CHECKLIST (To be completed by installer)

- Clearance test — Inflate the air springs to 60 PSI and ensure there is at least 1/2" clearance around each bellow, away from anything that might rub against them. Be sure to check the tire, brake drum, frame, shock absorbers and brake cables.
- Leak test before road test — Inflate the air springs to 60 PSI, check all connections for leaks with a soapy water solution. See the *Checking for Leaks* section for tips on how to spot leaks. All leaks must be eliminated before the vehicle is road tested.
- Heat test — Be sure there is sufficient clearance from any heat sources — at least 6" for air springs and air lines. If a heat shield was included in the kit, install it. If there is no heat shield, but one is required, call (800) 248-0892.
- Fastener test — Recheck all bolts for proper torque. Retorque after 100 miles.
- Road test — The vehicle should be road tested after the preceding tests. Inflate the air springs to 25 PSI (50 PSI if the vehicle is loaded). Drive the vehicle 10 miles and recheck for clearance, loose fasteners and air leaks.
- Operating instructions — If professionally installed, the installer should review the *Product Use, Maintenance and Servicing* section with the owner. Be sure to provide the owner with all of the paperwork which came with the kit.

Technician's Signature _____

Date _____

POST-INSTALLATION CHECKLIST

- Overnight leak down test — Recheck air pressure after the vehicle has been used for 24 hours. If the pressure has dropped more than 5 PSI, then there is a leak that must be fixed. Either fix the leak yourself or return to the installer for service.
- Air pressure requirements — Regardless of load, the air pressure should always be adjusted to maintain ride height at all times.
- Thirty day or 500 mile test — Recheck the air spring system after 30 days or 500 miles, whichever comes first. If any part shows signs of rubbing or abrasion, the source should be identified and moved, if possible. If it is not possible to relocate the cause of the abrasion, the air spring may need to be remounted. If professionally installed, the installer should be consulted. Check all fasteners for tightness.

Product Use, Maintenance and Servicing

Minimum Recommended Pressure	Maximum Air Pressure
5 PSI	100 PSI

MAINTENANCE GUIDELINES

NOTE

By following the steps below, vehicle owners will obtain the longest life and best results from their air springs.

1. Check the air pressure weekly.
2. Always maintain normal ride height. Never inflate beyond 100 PSI.
3. If you develop an air leak in the system, use a soapy water solution (1/5 liquid dish soap and 4/5 water) to check all air line connections and the inflation valve core before deflating and removing the air spring.

CAUTION

FOR YOUR SAFETY AND TO PREVENT POSSIBLE DAMAGE TO YOUR VEHICLE, DO NOT EXCEED MAXIMUM GROSS VEHICLE WEIGHT RATING (GVWR), AS INDICATED BY THE VEHICLE MANUFACTURER. ALTHOUGH YOUR AIR SPRINGS ARE RATED AT A MAXIMUM INFLATION PRESSURE OF 100 PSI, THE AIR PRESSURE ACTUALLY NEEDED IS DEPENDANT ON YOUR LOAD AND GVWR.

4. Loaded vehicles require at least 25 PSI or more. A “loaded vehicle” refers to a vehicle with a heavy bed load, a trailer, or both. As discussed above, never exceed GVWR, regardless of air spring, air pressure, or other load assist. The springs in this kit will support approximately 40 lbs. of load (combined on both springs) for each 1 PSI of pressure. The required air pressure will vary depending on the state of the original suspension. Operating the vehicle below the minimum air spring pressure will void the Air Lift warranty.
5. When increasing load, always adjust the air pressure to maintain the normal ride height. Increase or decrease pressure from the system as necessary to attain normal ride height for optimal ride and handling. Remember that loads carried behind the axle (including tongue loads) require more leveling force (pressure) than those carried directly over the axle.
6. Always add air to springs in small quantities, checking the pressure frequently.
7. Should it become necessary to raise the vehicle by the frame, make sure the system is at minimum pressure (5 PSI) to reduce the tension on the suspension/brake components. Use of on board leveling systems do not require deflation or disconnection.
8. Periodically check the air spring system fasteners for tightness. Also, check the air springs for any signs of rubbing. Realign if necessary.
9. On occasion, give the air springs a hard spray with a garden hose in order to remove mud, sand, gravel or other abrasive debris.

TROUBLESHOOTING GUIDE

1. Leak test the air line connections, the threaded connection into the air spring, and all fittings in the control system.
2. Inspect the air lines to be sure none are pinched. Tie straps may be too tight. Loosen or replace the strap and replace leaking components.
3. Inspect the air line for holes and cracks. Replace as needed.
4. Look for a kink or fold in the air line. Reroute as needed.

If the preceding steps do not solve the problem, it is possibly caused by a failed air spring — either a factory defect or an operating problem. Please call Air Lift at (800) 248-0892 for assistance.

FREQUENTLY ASKED QUESTIONS

Q. Will installing air springs increase the weight ratings of a vehicle?

No. Adding air springs will not change the weight ratings (GAWR, GCWR and/or GVWR) of a vehicle. Exceeding the GVWR is dangerous and voids the Air Lift warranty.

Q. Is it necessary to keep air in the air springs at all times and how much pressure will they need?

For LoadLifter 5000 Ultimate, the recommended minimum air pressure is 5 PSI, but it can safely be run at zero air pressure.

Q. Is it necessary to add a compressor system to the air springs?

No. Air pressure can be adjusted with any type of compressor as long as it can produce sufficient pressure to service the springs. Even a bicycle tire pump can be used, but it's a lot of work.

Q. How long should air springs last?

If the air springs are properly installed and maintained they can last indefinitely.

Q. Will raising the vehicle on a hoist for service work damage the air springs?

No. The vehicle can be lifted on a hoist for short-term service work such as tire rotation or oil changes. However, if the vehicle will be on the hoist for a prolonged period of time, support the axle with jack stands in order to take the tension off of the air springs.

TUNING THE AIR PRESSURE

Pressure determination comes down to three things — level vehicle, ride comfort, and stability.

1. Level vehicle

If the vehicle's headlights are shining into the trees or the vehicle is leaning to one side, then it is not level (fig. 2.1). Raise the air pressure to correct either of these problems and level the vehicle.

2. Ride comfort

If the vehicle has a rough or harsh ride it may be due to either too much pressure or not enough (fig. 2.2). Try different pressures to determine the best ride comfort.

3. Stability

Stability translates into safety and should be the priority, meaning the driver may need to sacrifice a perfectly level and comfortable ride. Stability issues include roll control, bounce, dive during braking and sponginess (fig. 2.3). Tuning out these problems usually requires an increase in pressure.



Bad headlight aim *fig. 2.1*



Rough ride *fig. 2.2*

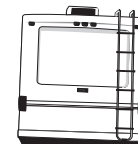

Sway and body roll *fig. 2.3*

GUIDELINES FOR ADDING AIR

1. Start with the vehicle level or slightly above.
2. When in doubt, always add air.
3. If the front of the vehicle dives while braking, increase the pressure in the front air bags, if equipped.
4. If it is ever suspected that the air bags have bottomed out, increase the pressure (fig. 2.4).
5. Adjust the pressure up and down to find the best ride.
6. If the vehicle rocks and rolls, adjust the air pressure to reduce movement.
7. It may be necessary to maintain different pressures on each side of the vehicle. Loads such as water, fuel, and appliances will cause the vehicle to be heavier on one side (fig. 2.5). As much as a 50 PSI difference is not uncommon.

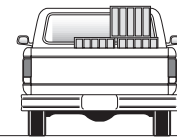
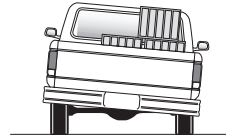

fig. 2.5

Choosing the Right On-Board Air Compressor System

60 DAY NO QUESTIONS ASKED, MONEY-BACK GUARANTEE

TWO YEAR COMPRESSOR SYSTEM WARRANTY

Add an on-board air compressor system to inflate and deflate your air springs with the touch of a button — from inside or outside of the vehicle.

- For convenient, on-the-go control of your air springs, add an Air Lift on-board air compressor system.
- Air Lift on-board air compressor systems eliminate the search for gas stations that have a working compressor, saving you time, energy and money.
- All systems include a compressor, controller and all parts needed for easy installation.

1. Choose single or dual path inflation (see illustrations at right)

2. Choose wireless or analog control

- **Wireless:** Control your air springs from inside or outside the vehicle. Easiest installation - no wires to the cab.
- **Analog:** In-cab control of your air springs. Economically priced.

3. Choose heavy or standard duty compressor

- **Standard duty:** A standard duty compressor will work well for most customers who use their system on an intermittent basis.
- **Heavy duty:** For daily use, consider the heavy duty compressor - it inflates faster and more quietly than the standard compressor.

Visit www.airliftcompany.com for more detailed info on compressor systems.

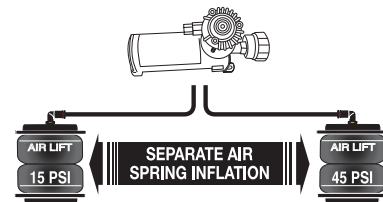

Dual path systems Air springs are controlled separately to allow for different air pressure from side-to-side. Perfect for uneven or top-heavy loads.

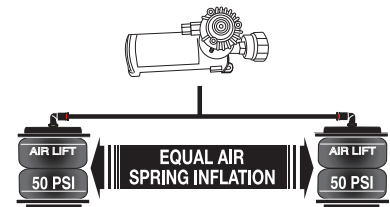

Single path systems Two springs will inflate at the same time. Good for loads that are evenly distributed from left-to-right or front-to-back.

WIRELESS

ANALOG

DUAL PATH

WirelessAIR™

PATENTED!

- Easy installation
- Includes heavy duty compressor



P/N 72000

LoadCONTROLLER™

Dual

Compact, economically priced control.

PATENT PENDING!



P/N Standard Duty Compressor 25850; P/N Heavy Duty mpressor 25854

SINGLE PATH

WirelessONE™

PATENTED!

- Easy installation
- Includes standard duty compressor



P/N 25870

LoadCONTROLLER™

Single

Compact, economically priced control.

PATENT PENDING!



P/N Standard Duty Compressor 25852; P/N Heavy Duty Compressor 25856



Warranty and Returns Policy

Air Lift Company warrants its products, for the time periods listed below, to the original retail purchaser against manufacturing defects when used on catalog-listed applications on cars, vans, light trucks and motorhomes under normal operating conditions for as long as Air Lift manufactures the product. The warranty does not apply to products that have been improperly applied, improperly installed, used in racing or off-road applications, used for commercial purposes, or which have not been maintained in accordance with installation instructions furnished with all products. The consumer will be responsible for removing (labor charges) the defective product from the vehicle and returning it, transportation costs prepaid, to the dealer from which it was purchased or to Air Lift Company for verification.

Air Lift will repair or replace, at its option, defective products or components. A minimum \$10.00 shipping and handling charge will apply to all warranty claims. Before returning any defective product, you must call Air Lift at (800) 248-0892 in the U.S. and Canada (elsewhere, (517) 322-2144) for a Returned Materials Authorization (RMA) number. Returns can be sent to: Air Lift Company • 2727 Snow Road • Lansing, MI • 48917.

Product failures resulting from abnormal use or misuse are excluded from this warranty. The loss of use of the product, loss of time, inconvenience, commercial loss or consequential damages is not covered. The consumer is responsible for installation/reinstallation (labor charges) of the product. Air Lift Company reserves the right to change the design of any product without assuming any obligation to modify any product previously manufactured.

This warranty gives you specific legal rights and you may also have other rights that vary from state-to-state. Some states do not allow limitations on how long an implied warranty lasts or allow the exclusion or limitation of incidental or consequential damages. The above limitation or exclusion may not apply to you. There are no warranties, expressed or implied including any implied warranties of merchantability and fitness, which extend beyond this warranty period. There are no warranties that extend beyond the description on the face hereof. Seller disclaims the implied warranty of merchantability. (Dated proof of purchase required.)

Air Lift 1000™	Lifetime Limited	LoadController/Dual™	2 Year Limited
RideControl™	Lifetime Limited	Load Controller™ (I)	2 Year Limited
LoadLifter 5000™*	Lifetime Limited	Load Controller™ (II)	2 Year Limited
LoadLifter 5000™ Ultimate ...	Lifetime Limited	SmartAir™	2 Year Limited
SlamAir™	Lifetime Limited	Wireless AIR™	2 Year Limited
AirCell™	Lifetime Limited	WirelessONE™	2 Year Limited
Air Lift Performance™**	1 Year Limited	Other Accessories	2 Year Limited
LoadController/Single™	2 Year Limited		

**formerly SuperDuty*

***formerly LifeSTYLE & Performance, EasyStreet*

Replacement Information

If you need replacement parts, contact the local dealer or call Air Lift customer service at (800) 248-0892. Most parts are immediately available and can be shipped the same day.

Contact Air Lift Company customer service at (800) 248-0892, first if:

- Parts are missing from the kit.
- Need technical assistance on installation or operation.
- Broken or defective parts in the kit.
- Wrong parts in the kit.
- Have a warranty claim or question.

Contact the retailer where the kit was purchased:

- If it is necessary to return or exchange the kit for any reason.
- If there is a problem with shipping if shipped from the retailer.
- If there is a problem with the price.

Contact Information

If you have any questions, comments or need technical assistance, contact our customer service department by calling (800) 248-0892, Monday through Friday. For calls from outside the USA or Canada, our local number is (517) 322-2144.

For inquiries by mail, our address is PO Box 80167, Lansing, MI 48908-0167. Our shipping address for returns is 2727 Snow Road, Lansing, MI 48917.

You may also contact us anytime by e-mail at sales@airliftcompany.com or on the web at www.airliftcompany.com.

Need Help?

Contact our customer service department by calling (800) 248-0892, Monday through Friday. For calls from outside the USA or Canada, our local number is (517) 322-2144.

**Register your warranty online at
www.airliftcompany.com/warranty**



Thank you for purchasing Air Lift products — the professional installer's choice!

Air Lift Company • 2727 Snow Road • Lansing, MI 48917 or PO Box 80167 • Lansing, MI 48908-0167
Toll Free (800) 248-0892 • Local (517) 322-2144 • Fax (517) 322-0240 • www.airliftcompany.com

Printed in
the USA