

# Load**LIFTER** 5000™ **ULTIMATE**

ADJUSTABLE AIR HELPER SPRINGS

TOW AND HAUL WITH SAFETY AND COMFORT™



Kit Number  
**88138**

## INSTALLATION GUIDE

For maximum effectiveness and safety, please read these instructions completely before proceeding with installation.

*Failure to read these instructions can result in an incorrect installation.*

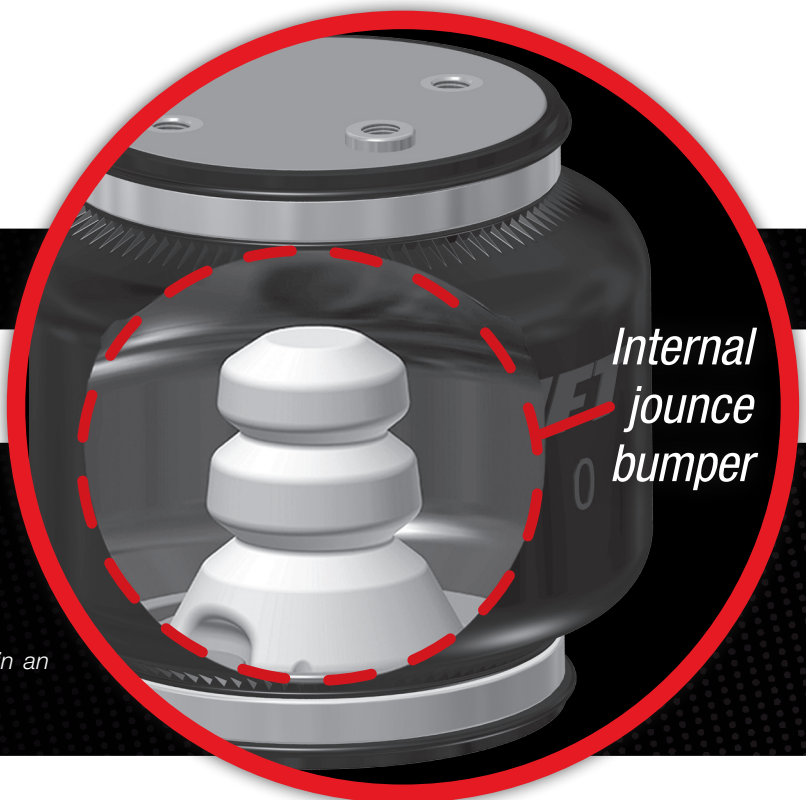



# TABLE OF CONTENTS

<b>Introduction</b> .....	<b>2</b>
Important Safety Notice .....	2
Notation Explanation .....	2
<b>Kit Hardware and Tools Lists</b> .....	<b>3</b>
<b>Installing the LoadLifter 5000 Ultimate System</b> .....	<b>4</b>
Getting Started .....	4
Assembling the Air Spring Unit .....	4
Lowering the Suspension .....	6
Attaching the Upper Bracket .....	6
Attaching the Lower Bracket .....	8
Installing the Air Lines .....	10
Installing the Heat Shield .....	11
Checking for Leaks .....	12
Fixing Leaks .....	12
<b>Before Operating</b> .....	<b>13</b>
Installation Checklist .....	13
Post-Installation Checklist .....	13
<b>Product Use, Maintenance and Servicing</b> .....	<b>14</b>
Minimum Recommended Pressure and Maximum Pressure .....	14
Maintenance Guidelines .....	14
Troubleshooting Guide .....	14
Frequently Asked Questions .....	15
Tuning the Air Pressure .....	15
Guidelines for Adding Air .....	16
<b>Choosing the Right On-Board Air Compressor System</b> .....	<b>17</b>
<b>Limited Warranty and Return Policy</b> .....	<b>18</b>
<b>Replacement Information</b> .....	<b>19</b>
<b>Contact Information</b> .....	<b>19</b>

# Introduction

The purpose of this publication is to assist with the installation, maintenance and troubleshooting of the LoadLifter 5000 Ultimate air spring kit. LoadLifter 5000 Ultimate utilizes sturdy, reinforced, commercial grade single or double, depending on the kit, convolute bellows. The bellows are manufactured like a tire with layers of rubber and cords that control growth. An internal jounce bumper inside the spring absorbs shock and eliminates harsh jarring on rough roads. The internal jounce bumper replaces the factory bumper and allows the air springs to safely be run at zero air pressure. LoadLifter 5000 Ultimate kits are recommended for most 3/4 and 1 ton pickups and SUVs with leaf springs and provide up to 5,000 lbs. of load leveling support with air adjustability from 5-100 PSI. The kits are used in motor home rear applications and various front applications where leaf springs are used.

It is important to read and understand the entire installation guide before beginning installation or performing any maintenance, service or repair. The information here includes a hardware list, tool list, step-by-step installation information, maintenance tips, safety information and a troubleshooting guide.

Air Lift Company reserves the right to make changes and improvements to its products and publications at any time. For the latest version of this manual, contact Air Lift Company at (800) 248-0892 or visit our website at [www.airliftcompany.com](http://www.airliftcompany.com).

## IMPORTANT SAFETY NOTICE

The installation of this kit does not alter the Gross Vehicle Weight Rating (GVWR) or payload of the vehicle. Check your vehicle's owner's manual and do not exceed the maximum load listed for your vehicle.

**Gross Vehicle Weight Rating:** The maximum allowable weight of the fully loaded vehicle (including passengers and cargo). This number — along with other weight limits, as well as tire, rim size and inflation pressure data — is shown on the vehicle's Safety Compliance Certification Label.

**Payload:** The combined, maximum allowable weight of cargo and passengers that the vehicle is designed to carry. Payload is GVWR minus the Base Curb Weight.

## NOTATION EXPLANATION

Hazard notations appear in various locations in this publication. Information which is highlighted by one of these notations must be observed to help minimize risk of personal injury or possible improper installation which may render the vehicle unsafe. Notes are used to help emphasize areas of procedural importance and provide helpful suggestions. The following definitions explain the use of these notations as they appear throughout this guide.

 **DANGER**

INDICATES IMMEDIATE HAZARDS WHICH WILL RESULT IN SEVERE PERSONAL INJURY OR DEATH.

 **WARNING**

INDICATES HAZARDS OR UNSAFE PRACTICES WHICH COULD RESULT IN SEVERE PERSONAL INJURY OR DEATH.

 **CAUTION**

INDICATES HAZARDS OR UNSAFE PRACTICES WHICH COULD RESULT IN DAMAGE TO THE MACHINE OR MINOR PERSONAL INJURY.

---

## NOTE

*Indicates a procedure, practice or hint which is important to highlight.*

---

# Kit Hardware and Tools Lists

## HARDWARE LIST

Item	Part #	Description .....	Qty
A	58740	Air Springs .....	2
B1	07463	Upper Bracket - Left Hand .....	1
B2	07464	Upper Bracket - Right Hand.....	1
C	03982	Lower Bracket .....	2
D	21837	90° Swivel Air Fitting.....	2
E	34365	Heat Shield Kit .....	1
F	10785	3/8"-16 x 6" U-Bolt.....	2
G	01775	Saddle Clamps.....	2
H	17103	5/16"-18 x 1" Hex Head Cap Screws ..	2
I	18438	5/16"-18 Nylon Lock Nut .....	2
J	18435	3/8"-16 Nylon Lock Nut .....	6
K	18444	3/8" Flat Washer .....	10
L	17405	3/8"-24 x 3/8"-16 Double End Stud ....	2
M	17203	3/8"-24 x 7/8" Hex Head Cap Screws .6	
N	18427	3/8" Lock Washer.....	6
O	11042	Brake Line Bracket (E-350).....	1
P	17444	M8 x 20 Bolt.....	1
Q	18501	M8 Flat Washer.....	1
R	18489	M8 x 1 Nylon Lock Nut.....	1
S	20086	Air Line Assembly .....	1
T	10466	Tie Strap .....	6
U	21230	Valve Caps.....	2
V	18405	5/16" Flat Washer .....	2
W	21234	Rubber Washer.....	2
X	18411	Star Washer.....	2
Y	21233	5/16" Hex Nut.....	2

## TOOLS LIST

Description.....	Qty
Jack .....	1
Jack Stands or hoist .....	2
1/2" Drive ratchet.....	1
3/8" Drive ratchet.....	1
18mm Socket.....	1
21mm and 22mm Sockets.....	1
1/2" Socket .....	1
22mm Wrench .....	1
1/2" Wrench .....	1
3/4" Wrench .....	1



Missing or damaged parts? Call Air Lift customer service at (800) 248-0892 for a replacement part.

# Installing the LoadLifter 5000 Ultimate System

**⚠ CAUTION**

YOUR VEHICLE MAY BE EQUIPPED WITH A REAR BRAKE PROPORTIONING VALVE. ANY TYPE OF LOAD ASSIST PRODUCT COULD AFFECT BRAKE PERFORMANCE. WE RECOMMEND THAT YOU CHECK WITH YOUR DEALER BEFORE INSTALLING THIS TYPE OF PRODUCT. IF YOUR VEHICLE DOES NOT HAVE A REAR BRAKE PROPORTIONING VALVE OR IS EQUIPPED WITH AN ANTI-LOCK TYPE BRAKE SYSTEM, INSTALLATION OF A LOAD ASSIST PRODUCT WILL HAVE NO EFFECT ON BRAKE SYSTEM PERFORMANCE.

**⚠ DANGER**

COMPRESSED AIR CAN CAUSE INJURY AND DAMAGE TO THE VEHICLE AND PARTS IF IT IS NOT HANDLED PROPERLY. FOR YOUR SAFETY, DO NOT TRY TO INFLATE THE AIR SPRINGS UNTIL THEY HAVE BEEN PROPERLY SECURED TO THE VEHICLE.

## GETTING STARTED

1. Determine the Normal Ride Height. The Normal Ride Height is the distance between the bottom edge of the wheel-well and the center of the hub with the vehicle in the “as delivered” condition. In some cases, Normal Ride Height is not perfectly level.
  - a. Remove unusual loads and examine your vehicle from the side to ensure it is on a level surface.
  - b. If necessary (in cases where your leaf springs are sagging badly), use a jack to raise the rear end so that the vehicle achieves the original “as delivered” ride height.
2. Measure the distance between the center of the hub and the bottom edge of the wheel well (see Fig. 1). This is the Normal Ride Height. Enter the measurement below:

NORMAL

RIDE HEIGHT: \_\_\_\_\_ inches



*fig. 1*

## ASSEMBLING THE AIR SPRING UNIT

1. The upper brackets are designated “Left” and “Right” indicated by “L” or “R” on the bracket. “L” for the driver side and “R” for the passenger side (Fig. 2).
2. Install 90 degree air swivel fitting (D) to the top of the air spring. Tighten 1 and 1/2 turns.
3. Align the right hand upper bracket (B2) with the mounting holes in the air spring and install the 3/8” stud (L) in the outboard tapped hole with the short threaded portion into the air spring (Fig. 3).

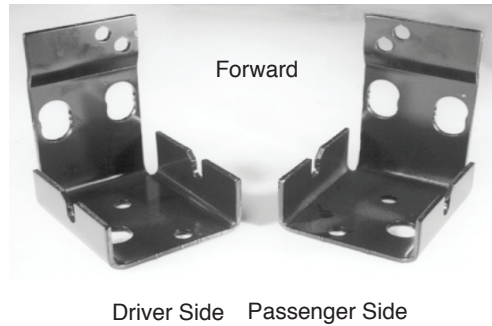

*fig. 2*

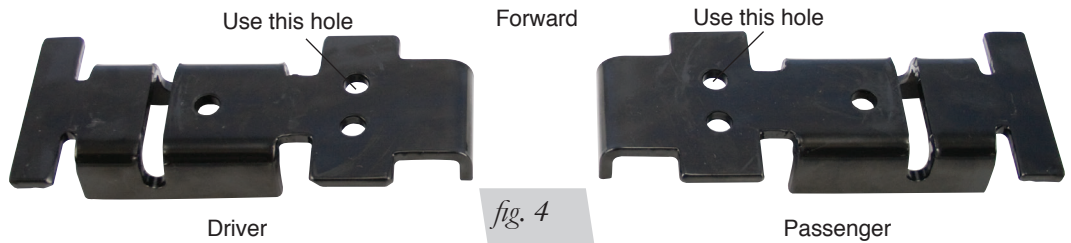

*fig. 3*

**NOTE**

*Finger tight only. Do not over tighten.*

4. LOOSELY install the 3/8" lock washer (N) and 3/8" x 7/8" hex head cap screws (M). Leave loose to allow installation of the upper bracket.
5. Attach the lower bracket (C) to the bottom of the air spring. Use the forward, inboard hole as shown in Fig. 4.



*fig. 4*

6. Secure lower bracket to the air spring using the 3/8" lock washers (N) and 3/8" x 7/8" hex head cap screws (M). Torque to 20 lb.-ft.
7. This completes the assembly of the Passenger side (Fig. 5). Now assemble the Driver side (left hand) in the same manner.



*fig. 5*



## LOWERING THE SUSPENSION

### NOTE

*It will be necessary to lower the suspension of the vehicle in order to provide clearance to install the air spring unit (Fig. 6). The following are tips on lowering the axle or raising the frame. Please review them and determine how to proceed:*

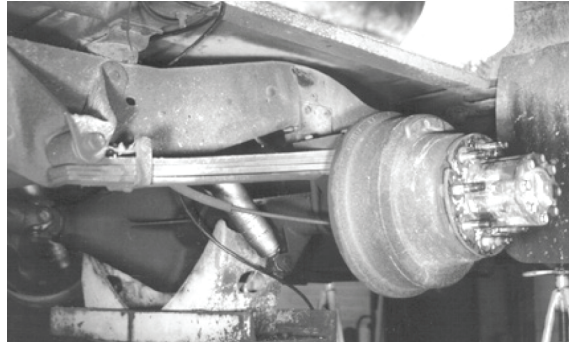
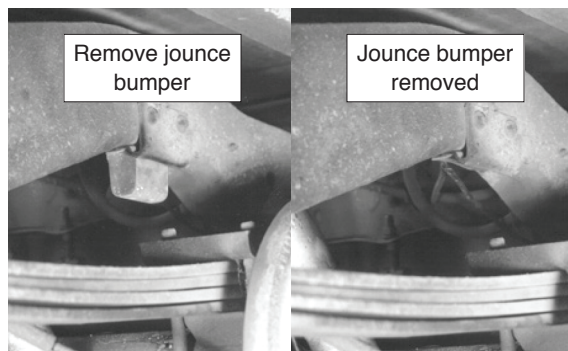

*fig. 6*

1. If the vehicle is raised with an axle contact hoist, place axle stands under the frame and lower the axle as needed.
2. If the vehicle is raised with a frame contact hoist, place axle stands under the axle and lower the frame as needed.
3. If the vehicle is raised with a jack and supported with axle stands on the frame, use a floor jack to lower the axle.

## ATTACHING THE UPPER BRACKET

1. Unbolt and remove the rubber jounce bumper from the frame rail and discard (Fig. 7).



*fig. 7*

2. With the 3/8" x 7/8" hex head bolt (M) **loose** in the air spring, insert the stud through the original jounce bumper mounting hole (Fig. 8).

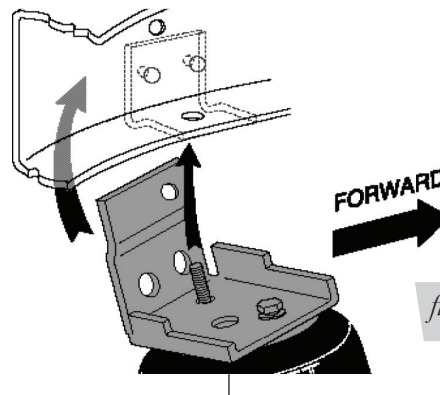

*fig. 8*



- Secure the stud using flat washer (K) and 3/8" lock nut (J). See Fig. 9. Torque stud nut to 16 lb.-ft.

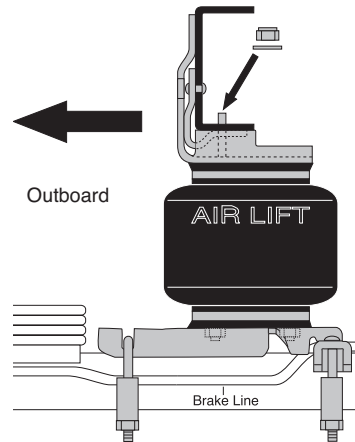

fig. 9

- Tighten the hex head bolt securely to 16 lb.-ft.
- LATE MODELS** have an existing hole that lines up with the top hole in the bracket so it will not be necessary to drill on these models. On some models the existing hole may have a plastic stud for a wiring harness hanger protruding through it. Push the plastic stud back through the frame and use the existing hole to mount the upper bracket to the side of the frame rail.

## NOTE

*If there is a vent tube under the brake line bracket on the driver side, then the upper bracket will hit on this during installation. This line will have to be relocated on top of the brake line bracket to provide clearance for the upper bracket.*

- If there is no hole, select one of the small holes on the outboard side of the upper bracket that is not on the radius edge of the frame rail.

## CAUTION

DO NOT DRILL HOLES INTO FRAME BEFORE CHECKING FOR HYDRAULIC LINES, GAS LINES AND/OR ELECTRICAL WIRES THAT MAY HAVE TO BE MOVED ASIDE ON EITHER SIDE OF THE FRAME. USING THE UPPER BRACKET AS A TEMPLATE, CENTER-PUNCH THE HOLE LOCATION TO BE DRILLED (FIG. 10A). DRILL A 5/16" HOLE IN THE FRAME RAIL (FIG. 10B).

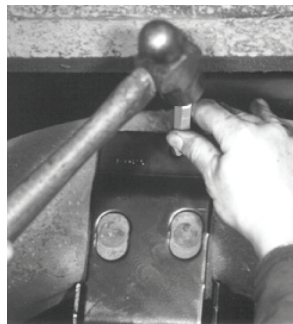

fig. 10a



fig. 10b

- Install 5/16" x 1" hex head cap screws (H), flat washers (K) and 5/16" lock nut (J). Torque to 15 lb.-ft. (Fig. 11).

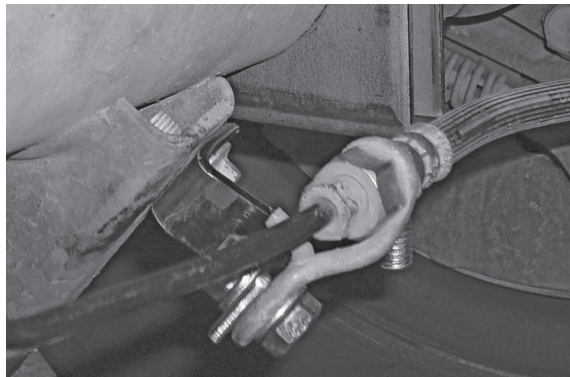

fig. 11

## ATTACHING THE LOWER BRACKET

**NOTE**

Most late model vehicles have a small brake line hanger on the passenger side shock bracket that is welded to the axle (Fig. 12). Remove the bolt holding the wire brake line bracket to the shock mount. Move line aside and attach the brake line bracket spacer (O) to the axle using the existing M8 bolt removed. Attach the stock brake line bracket to the brake line bracket spacer with the M8 bolt (P), washer (Q) and nut (R) provided. Tighten both securely (Fig. 13).

*fig. 12*

*fig. 13*

1. Set the assembly on the axle and check for the following.

**NOTE**

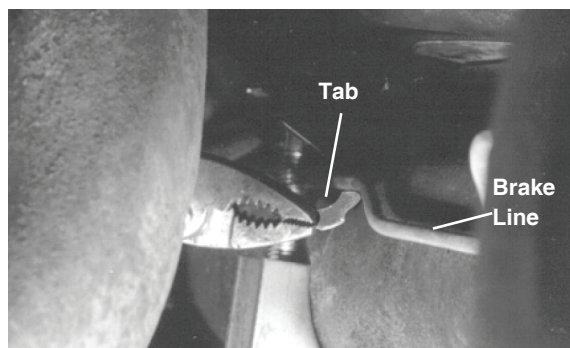
On some models with drum brakes: check to be sure that the lower bracket is not pinching the brake line on the axle. If it is then, bend the tab holding the brake line away from the axle housing (Fig. 14). Reposition the line and bend the tab back to hold the line in the new position away from the lower bracket leg.

*fig. 14*

2. Position the lower bracket so that the outboard edge is between the leaf spring U-bolts (Fig 15). Insert the U-bolt (F) provided in the outboard slot of the lower bracket (Fig. 18).

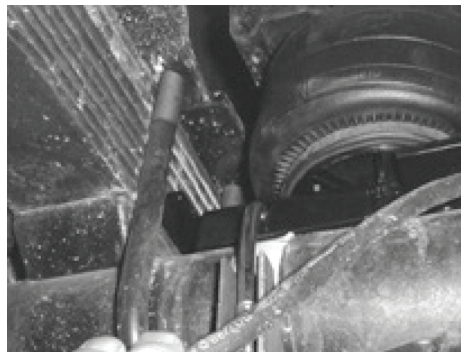
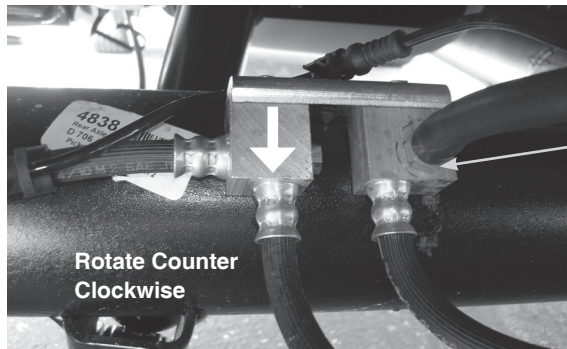

fig. 15



Axle Vent Tube Bolt

fig. 16

## NOTE

Some late models are equipped with the RSC (roll stability control) system (Fig. 16). On these models it will be necessary to loosen the axle vent tube bolt and rotate the brake line junction box counter clockwise as far as it will let you. Tighten the axle vent tube bolt securely (Fig. 17).

3. Secure the lower bracket to the axle using the saddle clamps (G), flat washers (K) and 3/8" nuts (J). See Fig. 18.
4. Torque the nuts to 16 lb.-ft. (Fig. 18). Trim excess bolt off if desired.

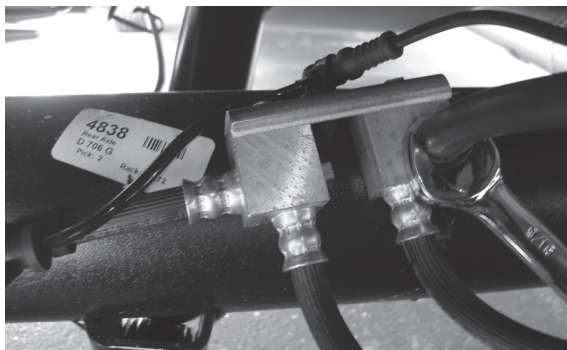

fig. 17

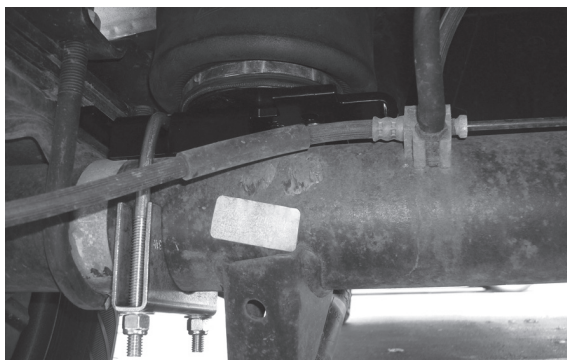

fig. 18

## INSTALLING THE AIR LINES

1. Choose a convenient location for mounting the inflation valves. Popular locations for the inflation valve are:
  - a. The wheel well flanges
  - b. The license plate recess in bumper
  - c. Under the gas cap access door
  - d. Through the license plate

### NOTE

*Whatever the chosen location, make sure there is enough clearance around the inflation valves for an air chuck.*

2. Drill two 5/16" holes to install the inflation valves.
3. Cut the air line assembly in two equal lengths.

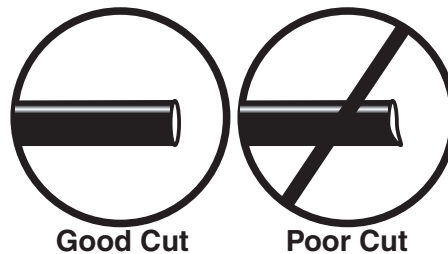

*fig. 19*

### CAUTION

WHEN CUTTING OR TRIMMING THE AIR LINE, USE A HOSE CUTTER, A RAZOR BLADE, OR A SHARP KNIFE. A CLEAN, SQUARE CUT WILL PREVENT LEAKS. DO NOT USE WIRE CUTTERS OR SCISSORS TO CUT THE AIR LINE. THESE TOOLS MAY FLATTEN OR CRIMP THE AIR LINE CAUSING IT TO LEAK AROUND THE O-RING SEAL INSIDE THE ELBOW FITTING (FIG. 19).

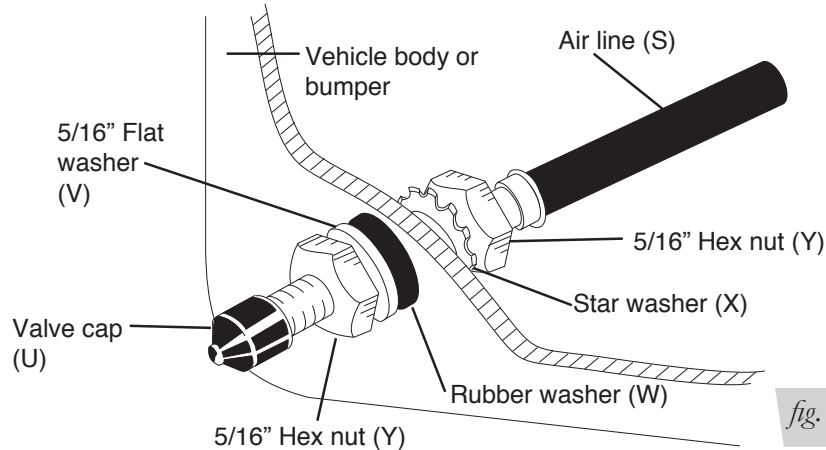

*fig. 20*

4. Place a 5/16" nut and star washer (X) on the air valve. Leave enough of the inflation valve in front of the nut to extend through the hole and have room for the rubber washer (W), flat washer (V), and 5/16" nut (Y) and valve cap (U). There should be enough valve exposed after installation — approximately 1/2" — to easily apply a pressure gauge or an air chuck (Fig. 20).
5. Push the inflation valve through the hole and use the rubber washer, flat washer, and another 5/16" nut to secure it in place. Tighten the nuts to secure the assembly.
6. Route the air line along the frame to the air fitting on the air spring (Fig. 21). Keep AT LEAST 6" of clearance between the air line and heat sources, such as the exhaust pipes, muffler, or catalytic converter. Avoid sharp bends and edges. Use the plastic tie straps (T) to secure the air line to fixed, non-moving points along the chassis. Be sure that the tie straps are tight, but do not pinch the air line. Leave at least 2" of slack to allow for any movement that might pull on the air line (Fig. 21).

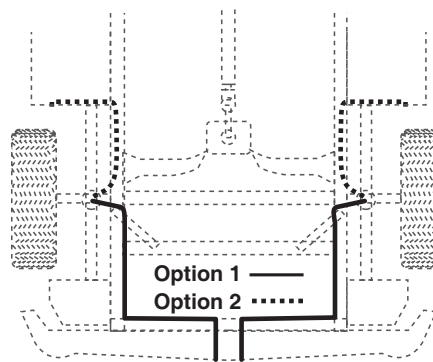
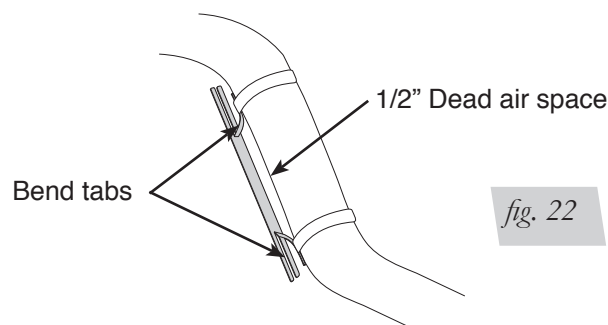

*fig. 21*

7. Cut off the air line, leaving approximately 12" of extra air line. A clean square cut will ensure against leaks. Insert the air line into the air fitting. This is a push-to-connect fitting. Simply push the air line into the 90° swivel fitting (D) until it bottoms out (9/16" of air line should be in the fitting).
8. Install the minimum/maximum air pressure decal in a highly visible location. We suggest placing the decal on the driver-side window, just above the door handle.

### **INSTALLING THE HEAT SHIELD**

1. Bend tabs to provide a 1/2" dead air space between exhaust pipe and heat shield (Fig. 22).
2. Attach the heat shield to the exhaust pipe using the clamps. Bend the heat shield for maximum clearance to the air spring (Fig. 22).



*fig. 22*

## CHECKING FOR LEAKS

1. Inflate the air spring to 30 PSI.
2. Spray all connections and the inflation valves with a solution of 1/5 liquid dish soap and 4/5 water. Spot leaks easily by looking for bubbles in the soapy water.
3. After the test, deflate the springs to the minimum pressure required to restore the system to normal ride height. Do not deflate to lower than 5 PSI.
4. Check the air pressure again after 24 hours. A 2 - 4 PSI loss after initial installation is normal. Retest for leaks if the loss is more than 5 lbs.

## FIXING LEAKS

1. If there is a problem with the swivel fitting:
  - a. Check the air line connection by deflating the spring and removing the line by pulling the collar against the fitting and pulling firmly on the air line. Trim 1" off the end of the air line. Be sure the cut is clean and square (see Fig. 19). Reinsert the air line into the push-to-connect fitting.
  - b. Check the threaded connection by tightening the swivel fitting another 1/2 turn. If it still leaks, deflate the air spring, remove the fitting, and re-coat the threads with thread sealant. Reinstall by hand tightening as much as possible and then use a wrench for an additional two turns.
2. If there is a problem with the inflation valve:
  - a. Check the valve core by tightening it with a valve core tool.
  - b. Check the air line by removing the air line from the barbed type fitting. Cut the air line off a few inches in front of the fitting and use a pair of pliers or vice grips to pull/twist the air line off of the fitting.

 **CAUTION**

DO NOT CUT OFF THE AIR LINE COMPLETELY AS THIS WILL USUALLY NICK THE BARB AND RENDER THE FITTING USELESS.

3. If the preceding steps have not resolved the problem, call Air Lift customer service at (800) 248-0892.



# Before Operating

## INSTALLATION CHECKLIST (To be completed by installer)

- Clearance test — Inflate the air springs to 60 PSI and ensure there is at least 1/2" clearance around each bellow, away from anything that might rub against them. Be sure to check the tire, brake drum, frame, shock absorbers and brake cables.
- Leak test before road test — Inflate the air springs to 60 PSI, check all connections for leaks with a soapy water solution. See page 12 for tips on how to spot leaks. All leaks must be eliminated before the vehicle is road tested.
- Heat test — Be sure there is sufficient clearance from any heat sources — at least 6" for air springs and air lines. If a heat shield was included in the kit, install it. If there is no heat shield, but one is required, call (800) 248-0892.
- Fastener test — Recheck all bolts for proper torque. Axle clamp bar carriage bolt lock nuts should be torqued to 16 lb.-ft. Re-torque after 100 miles.
- Road test — The vehicle should be road tested after the preceding tests. Inflate the air springs to 25 PSI (50 PSI if the vehicle is loaded). Drive the vehicle 10 miles and recheck for clearance, loose fasteners and air leaks.
- Operating instructions — If professionally installed, the installer should review the Product Use, Maintenance and Servicing section on page 14 with the owner. Be sure to provide the owner with all of the paperwork which came with the kit.

**Technician's Signature** \_\_\_\_\_

**Date** \_\_\_\_\_

## POST-INSTALLATION CHECKLIST

- Overnight leak down test — Recheck air pressure after the vehicle has been used for 24 hours. If the pressure has dropped more than 5 PSI, then there is a leak that must be fixed. Either fix the leak yourself or return to the installer for service.
- Air pressure requirements — Regardless of load, the air pressure should always be adjusted to maintain ride height at all times.
- Thirty day or 500 mile test — Recheck the air spring system after 30 days or 500 miles, whichever comes first. If any part shows signs of rubbing or abrasion, the source should be identified and moved, if possible. If it is not possible to relocate the cause of the abrasion, the air spring may need to be remounted. If professionally installed, the installer should be consulted. Check all fasteners for tightness.



# Product Use, Maintenance and Servicing

Minimum Recommended Pressure	Maximum Air Pressure
5 PSI	100 PSI

## MAINTENANCE GUIDELINES

### NOTE

*By following the steps below, vehicle owners will obtain the longest life and best results from their air springs.*

1. Check the air pressure weekly.
2. Always maintain normal ride height. Never inflate beyond 100 PSI.
3. If you develop an air leak in the system, use a soapy water solution (1/5 liquid dish soap and 4/5 water) to check all air line connections and the inflation valve core before deflating and removing the air spring.

### CAUTION

FOR YOUR SAFETY AND TO PREVENT POSSIBLE DAMAGE TO YOUR VEHICLE, DO NOT EXCEED MAXIMUM GROSS VEHICLE WEIGHT RATING (GVWR), AS INDICATED BY THE VEHICLE MANUFACTURER. ALTHOUGH YOUR AIR SPRINGS ARE RATED AT A MAXIMUM INFLATION PRESSURE OF 100 P.S.I., THE AIR PRESSURE ACTUALLY NEEDED IS DEPENDANT ON YOUR LOAD AND GVWR.

4. Loaded vehicles require at least 25 PSI or more. A “loaded vehicle” refers to a vehicle with a heavy bed load, a trailer, or both. As discussed above, never exceed GVWR, regardless of air spring, air pressure, or other load assist. The springs in this kit will support approximately 40 lbs. of load (combined on both springs) for each 1 PSI of pressure. The required air pressure will vary depending on the state of the original suspension. Operating the vehicle below the minimum air spring pressure will void the Air Lift warranty.
5. When increasing load, always adjust the air pressure to maintain the normal ride height. Increase or decrease pressure from the system as necessary to attain normal ride height for optimal ride and handling. Remember that loads carried behind the axle (including tongue loads) require more leveling force (pressure) than those carried directly over the axle.
6. Always add air to springs in small quantities, checking the pressure frequently.
7. Should it become necessary to raise the vehicle by the frame, make sure the system is at minimum pressure (5 PSI) to reduce the tension on the suspension/brake components. Use of on board leveling systems do not require deflation or disconnection.
8. Periodically check the air spring system fasteners for tightness. Also, check the air springs for any signs of rubbing. Realign if necessary.
9. On occasion, give the air springs a hard spray with a garden hose in order to remove mud, sand, gravel or other abrasive debris.

## TROUBLESHOOTING GUIDE

1. Leak test the air line connections, the threaded connection into the air spring, and all fittings in the control system.
2. Inspect the air lines to be sure none are pinched. Tie straps may be too tight. Loosen or replace the strap and replace leaking components.
3. Inspect the air line for holes and cracks. Replace as needed.
4. Look for a kink or fold in the air line. Reroute as needed.

If the preceding steps do not solve the problem, it is possibly caused by a failed air spring — either a factory defect or an operating problem. Please call Air Lift at (800) 248-0892 for assistance.

## FREQUENTLY ASKED QUESTIONS

**Q. Will installing air springs increase the weight ratings of a vehicle?**

No. Adding air springs will not change the weight ratings (GAWR, GCWR and/or GVWR) of a vehicle. Exceeding the GVWR is dangerous and voids the Air Lift warranty.

**Q. Is it necessary to keep air in the air springs at all times and how much pressure will they need?**

For LoadLifter 5000 Ultimate, the recommended minimum air pressure is 5 PSI, but it can safely be run at zero air pressure.

**Q. Is it necessary to add a compressor system to the air springs?**

No. Air pressure can be adjusted with any type of compressor as long as it can produce sufficient pressure to service the springs. Even a bicycle tire pump can be used, but it's a lot of work.

**Q. How long should air springs last?**

If the air springs are properly installed and maintained they can last indefinitely.

**Q. Will raising the vehicle on a hoist for service work damage the air springs?**

No. The vehicle can be lifted on a hoist for short-term service work such as tire rotation or oil changes. However, if the vehicle will be on the hoist for a prolonged period of time, support the axle with jack stands in order to take the tension off of the air springs.

## TUNING THE AIR PRESSURE

Pressure determination comes down to three things — level vehicle, ride comfort, and stability.

**1. Level vehicle**

If the vehicle's headlights are shining into the trees or the vehicle is leaning to one side, then it is not level (Fig. 2.1). Raise the air pressure to correct either of these problems and level the vehicle.

**2. Ride comfort**

If the vehicle has a rough or harsh ride it may be due to either too much pressure or not enough (Fig. 2.2). Try different pressures to determine the best ride comfort.

**3. Stability**

Stability translates into safety and should be the priority, meaning the driver may need to sacrifice a perfectly level and comfortable ride. Stability issues include roll control, bounce, dive during braking and sponginess (Fig. 2.3). Tuning out these problems usually requires an increase in pressure.



Bad headlight aim *fig. 2.1*



Rough ride *fig. 2.2*



Sway and body roll *fig. 2.3*

## GUIDELINES FOR ADDING AIR

1. Start with the vehicle level or slightly above.
2. When in doubt, always add air.
3. If the front of the vehicle dives while braking, increase the pressure in the front air bags, if equipped.
4. If it is ever suspected that the air bags have bottomed out, increase the pressure (Fig. 2.4).
5. Adjust the pressure up and down to find the best ride.
6. If the vehicle rocks and rolls, adjust the air pressure to reduce movement.
7. It may be necessary to maintain different pressures on each side of the vehicle. Loads such as water, fuel, and appliances will cause the vehicle to be heavier on one side (Fig. 2.5). As much as a 50 PSI difference is not uncommon.

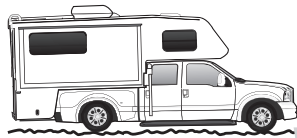

Bottoming out

*fig. 2.4*

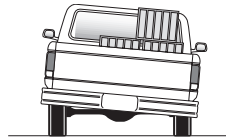

Unlevel

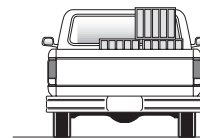

Level

*fig. 2.5*

# Choosing the Right On-Board Air Compressor System

**60 DAY** NO QUESTIONS ASKED, MONEY-BACK GUARANTEE

**TWO-YEAR** COMPRESSOR SYSTEM WARRANTY

Add an on-board air compressor system to inflate and deflate your air springs automatically or with the touch of a button — from inside or outside of the vehicle.

- For convenient, on-the-go control of your air springs, add an Air Lift on-board air compressor system.
- Air Lift on-board air compressor systems eliminate the search for gas stations that have a working compressor, saving you time, energy and money.
- All systems include a compressor, controller and all parts needed for easy installation.

**1. Choose single or dual path inflation (see illustrations at right)**

**2. Choose wireless, analog control or automatic**

- **Wireless:** Control your air springs from inside or outside the vehicle. Easiest installation — no wires to the cab.
- **Analog:** In-cab control of your air springs. Economically priced.
- **Automatic:** Self-leveling system, keeps the vehicle level no matter what.

**3. Choose heavy or standard duty compressor**

- **Standard duty:** A standard duty compressor will work well for most customers who use their system on an intermittent basis.
- **Heavy duty:** For daily use, consider the heavy-duty compressor — it inflates faster and more quietly than the standard compressor.

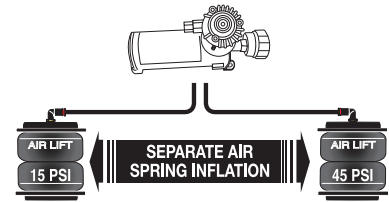

**Dual path systems** Air springs are controlled separately to allow for different air pressure from side-to-side. Perfect for uneven or top-heavy loads.

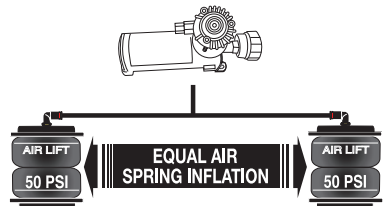

**Single path systems** Two springs will inflate at the same time. Good for loads that are evenly distributed from left-to-right or front-to-back.

Visit [www.airliftcompany.com](http://www.airliftcompany.com) for more detailed info on compressor systems.

WIRELESS

ANALOG

AUTOMATIC

**WirelessAIR™**

**OUR PREMIUM SYSTEM!**

- Easy installation
- Includes heavy-duty compressor



P/N 72000

**LoadCONTROLLER™**

**Dual**

Compact, economically priced control.

P/N Standard Duty Compressor 25850; P/N Heavy Duty Compressor 25854



**WirelessONE™**

- Easy installation
- Includes standard-duty compressor



P/N 25870

**LoadCONTROLLER™**

**Single**

Compact, economically priced control.

P/N Standard Duty Compressor 25852; P/N Heavy Duty Compressor 25856



**SmartAIR™ II**

- Easy installation
- Automatic self-leveling system
- No in-cab controls required



Single Path P/N 25490, Dual Path P/N 25491



# Limited Warranty and Return Policy

## WHAT THIS WARRANTY COVERS

Air Lift Company provides a warranty to the original purchaser of its Load Support Products, for the periods of time listed below, by product line, from the date of original purchase, that the products will be free from defects in workmanship and materials when used on cars and trucks as specified by Air Lift Company and under normal operating conditions, subject to the requirements and exclusions set forth below.

## WHAT THIS WARRANTY DOES NOT COVER

The warranty does not apply to products that have been improperly applied, improperly installed, or which have not been maintained in accordance with installation instructions furnished with all products. This warranty does not apply and is void if damage or failure is caused by: accident, abuse, misuse (including but not limited to racing or off-road activities or commercial use), abnormal use, faulty installation, liquid contact, fire, earthquake or other external cause; operating the product outside Air Lift Company’s instructions, specifications or guidelines; or service, alteration, maintenance or repairs performed by anyone other than Air Lift Company to the product from its purchased condition. This warranty also does not apply to: consumable parts, such as batteries; cosmetic damage, including but not limited to scratches or dents; defects caused by normal wear and tear or otherwise due to the normal aging of the product, or if any serial or identification number has been removed or defaced from the product. Air Lift Company reserves the right to change the design of any product without assuming any obligation to modify any product previously manufactured.

## LIMITATION OF LIABILITY

To the extent permitted by law, this warranty and the remedies set forth herein are exclusive and in lieu of all other warranties, remedies and conditions, whether oral, written, statutory, express or implied. AIR LIFT COMPANY DISCLAIMS ALL STATUTORY AND IMPLIED WARRANTIES, INCLUDING WITHOUT LIMITATION, WARRANTIES OF MERCHANTABILITY AND FITNESS FOR A PARTICULAR PURPOSE AND WARRANTIES AGAINST HIDDEN OR LATENT DEFECTS TO THE EXTENT PERMITTED BY LAW. To the extent such warranties cannot be disclaimed, such implied warranties shall apply only for the warranty period specified above. Please note that some states do not allow limitation on how long an implied warranty (or condition) lasts. So the above limitation may not apply to you.

Except as provided in this warranty and to the extent permitted by law, Air Lift Company shall not be liable for any direct, special, incidental or consequential damages resulting from any breach of warranty or condition, or arising in connection with the sale, use or repair of air lift products, or under any other legal theory, including but not limited to loss of use, loss of revenue, loss of actual or anticipated profits, loss of the use of money, loss of business, loss of opportunity, loss of goodwill, and loss of reputation. Air Lift Company’s maximum liability shall not in any case exceed the purchase price paid by you for the Air Lift product. Please note that some states do not allow the exclusion or limitation of incidental or consequential damages, so the above limitation or exclusion may not apply to you.

## HOW TO GET SERVICE

If a defect in workmanship or materials causes your Air Lift product to become inoperable within the warranty period, before returning any defective product, call Air Lift Company at (800) 248-0892 in the U.S. and Canada (elsewhere, (517) 322-2144) to obtain a Returned Materials Authorization (RMA) number. The consumer shall be responsible for removing (labor charges) the defective product from the vehicle and returning it, shipping costs prepaid, to Air Lift Company for verification. Returns to Air Lift Company must be postage prepaid and sent to: Air Lift Company • 2727 Snow Road • Lansing, MI • 48917. You must prove to the satisfaction of Air Lift Company the date of original purchase of your Air Lift product. You must also enclose the RMA number and a return address. A minimum \$10 shipping and handling charge will apply to all warranty claims. You must also pack the product to minimize the risk of it being damaged in transit. If we receive a product in damaged condition as the result of shipping, we will notify you and you must seek a claim with the shipper.

## WHAT AIR LIFT COMPANY WILL DO

If you submit a valid claim to Air Lift Company during the warranty period, Air Lift Company will, at its option, repair your Air Lift product or furnish you with a new or rebuilt product. Air Lift Company will not reimburse you for repairs or replacement parts provided by other parties. Your repaired or replacement Air Lift product will be returned to you (subject to payment of the required warranty claim shipping and handling charge) and it will be covered under the warranty for the balance of the warranty period, if any. When a product or part is replaced, any replacement item becomes your property and the replaced item becomes property of Air Lift Company. You are responsible for installation/reinstallation (labor charges) of the product.

## HOW THE LAW RELATES TO THIS WARRANTY

This warranty gives you specific legal rights and you may also have other rights which vary from state to state. By this warranty, Air Lift Company does not limit or exclude your rights except as allowed by law. To fully understand your rights, you should consult the laws of your state.

## SPECIFIC LOAD SUPPORT WARRANTY PERIODS BY PRODUCT LINE

LoadLifter 5000™ Ultimate.....	Lifetime Limited	WirelessAIR™.....	2 Year Limited
LoadLifter 5000™.....	Lifetime Limited	WirelessONE™.....	2 Year Limited
RideControl™.....	Lifetime Limited	LoadController™ Single and Dual.....	2 Year Limited
Air Lift 1000™.....	Lifetime Limited	LoadController™ I and II.....	2 Year Limited
AirCell™.....	Lifetime Limited	SmartAir™ II.....	2 Year Limited
SlamAir™.....	Lifetime Limited	Other Accessories.....	2 Year Limited

# Replacement Part Information

If replacement parts are needed, contact the local dealer or call Air Lift customer service at **(800) 248-0892**. Most parts are immediately available and can be shipped the same day.

**Contact Air Lift Company customer service at (800) 248-0892 first if:**

- Parts are missing from the kit.
- Need technical assistance on installation or operation.
- Broken or defective parts in the kit.
- Wrong parts in the kit.
- Have a warranty claim or question.

**Contact the retailer where the kit was purchased:**

- If it is necessary to return or exchange the kit for any reason.
- If there is a problem with shipping if shipped from the retailer.
- If there is a problem with the price.

# Contact Information

<b>Mailing address</b>	P.O. Box 80167 Lansing, MI 48908-0167
<b>Shipping address for returns</b>	2727 Snow Road Lansing, MI 48917
<b>Phone</b>	Toll free: (800) 248-0892 International: (517) 322-2144
<b>Email</b>	<a href="mailto:service@airliftcompany.com">service@airliftcompany.com</a>
<b>Web address</b>	<a href="http://www.airliftcompany.com">www.airliftcompany.com</a>



# Notes





## Need Help?

Contact our customer service department by calling (800) 248-0892, Monday through Friday. For calls from outside the USA or Canada, our local number is (517) 322-2144.

**Register your warranty online at  
[www.airliftcompany.com/warranty](http://www.airliftcompany.com/warranty)**



*Thank you for purchasing Air Lift products — the professional installer's choice!*

Air Lift Company • 2727 Snow Road • Lansing, MI 48917 or PO Box 80167 • Lansing, MI 48908-0167  
Toll Free (800) 248-0892 • Local (517) 322-2144 • Fax (517) 322-0240 • [www.airliftcompany.com](http://www.airliftcompany.com)

Printed in the USA  
JJC-0816