



Kit 27666

Manual Air
Management System



INSTALLATION GUIDE

For maximum effectiveness and safety, please read these instructions completely before proceeding with installation.

Failure to read these instructions can result in an incorrect installation.



TABLE OF CONTENTS

Introduction	2
Important Safety Notice	2
Notation Explanation	2
Hardware List.	3
NPT Assembly Instructions	3
Helpful Tips: Air Line and Fittings	3
Installing the Air Management System	4
Install Components	4
Mounting the Switch Panel	5
Attaching the Air Lines.	5
Troubleshooting Guide	6
Tuning the Air Pressure	7
Leak Testing and Detection	7
Installation Diagram	8-9
Electrical Schematic	12
Paddle Switch Mounting Bracket Template	13
16380 Compressor Template	15
Limited Warranty and Return Policy	16
How to Obtain Replacement Parts.	17
Contact Information	17



Introduction

The purpose of this publication is to assist with the installation, maintenance and troubleshooting of the Air Management System.

It is important to read and understand the entire installation guide before beginning installation or performing any maintenance, service or repair. The information here includes a hardware list, tool list, step-by-step installation information, maintenance guidelines and troubleshooting guide.

Air Lift Company reserves the right to make changes and improvements to its products and publications at any time. For the latest version of this manual, contact Air Lift Company at (800) 248-0892 or visit our website at www.airliftcompany.com.

IMPORTANT SAFETY NOTICE

The installation of this kit does not alter the Gross Vehicle Weight Rating (GVWR) or payload of the vehicle. Check your vehicle's owner's manual and do not exceed the maximum load listed for your vehicle.

Gross Vehicle Weight Rating: The maximum allowable weight of the fully loaded vehicle (including passengers and cargo). This number — along with other weight limits, as well as tire, rim size and inflation pressure data — is shown on the vehicle's Safety Compliance Certification Label.

Payload: The combined, maximum allowable weight of cargo and passengers that the vehicle is designed to carry. Payload is GVWR minus the Base Curb Weight.

NOTATION EXPLANATION

Hazard notations appear in various locations in this publication. Information which is highlighted by one of these notations must be observed to help minimize risk of personal injury or possible improper installation which may render the vehicle unsafe. Notes are used to help emphasize areas of procedural importance and provide helpful suggestions. The following definitions explain the use of these notations as they appear throughout this guide.



INDICATES IMMEDIATE HAZARDS WHICH WILL RESULT IN SEVERE PERSONAL INJURY OR DEATH.



INDICATES HAZARDS OR UNSAFE PRACTICES WHICH COULD RESULT IN SEVERE PERSONAL INJURY OR DEATH.



INDICATES HAZARDS OR UNSAFE PRACTICES WHICH COULD RESULT IN DAMAGE TO THE MACHINE OR MINOR PERSONAL INJURY.

NOTE

Indicates a procedure, practice or hint which is important to highlight.

Hardware List

Item	Part #	Description	Quantity	Item	Part #	Description	Quantity
A	16380	Viair 380C Compressor	1	Electrical			
B	11955	4 Gallon Aluminum Air Tank	1	R	24782	30/50A Relay	1
C	26228	Dual Needle Gauge	2	S	24608	10 Gauge Red Wire	15'
D	21703	Paddle Switch	4	T	24643	16 Gauge Red Wire	20'
E	11031	Paddle Switch Mounting Bracket	1	U	24644	16 Gauge Black Wire	10'
F	20946	1/4" Airline	80'	V	24537	Quick Splice	3
G	10530	Air Line Cutter	1	W	24568	18 Gauge Ring Terminal	2
H	24575	145 - 175 PSI Pressure Switch	1	X	24594	Blue Female Spade Terminal	9
Paddle Switch Mounting Bracket Hardware				Y	24748	12 Gauge Ring Terminal 3/8" ID	1
I	17434	#8 x 3/4" Stainless Steel Screw	4	Z	24542	Fuse Tap	1
Tank Mounting Hardware				AA	24561	Mini Fuse Adapter	1
J	17188	3/8"-16 x 1.25" Grade 5 Bolt	4	BB	24649	Yellow Butt Connector	1
K	18444	3/8" Flat Washer	8	CC	24595	Yellow Female Spade Terminal	2
L	18435	3/8"-16 Nyloc Nut	4	DD	17263	1/4" x 1" Self Threading Screw	1
Tank Fittings				EE	24539	Fuse Holder	1
M	21737	3/8" Pipe Plug	1	FF	24547	30A Spade Fuse	1
N	21738	1/4" FNPT x 3/8" MNPT Bushing	1	GG	17132	1/2" Self Threading Screw	2
O	21779	1/4" NPT x 1/4" Tube Elbow	2	Gauge and Paddle Switch Fittings			
P	21610	1/8" FNPT x 1/4" MNPT Bushing	1	HH	21838	1/4" Union Tee	4
Q	21633	Inflation Valve	1	II	21842	1/4" Y Tee	3



Missing or damaged parts? Call Air Lift customer service at (800) 248-0892 for a replacement part.

NPT ASSEMBLY INSTRUCTIONS

1. Inspect the port and fitting ensuring both are free of contaminants and excessive burrs and nicks.
2. Apply a stripe of liquid pipe sealant around the male threads leaving the first two threads uncovered.
3. Screw finger tight into the port.
4. Wrench tighten the fitting to the correct turns past finger tight position (see table 1).



NEVER BACK OFF AN INSTALLED PIPE FITTING TO ACHIEVE PROPER ALIGNMENT. LOOSENING INSTALLED PIPE FITTINGS WILL CORRUPT THE SEAL AND CONTRIBUTE TO LEAKAGE AND FAILURE.

Torque Specifications		
Fitting Size	Turns Past Finger Tight	Torque lb/ft
1/8" NPT	1.5 - 3.0	12
1/4" NPT	1.5 - 3.0	25
3/8" NPT	1.5 - 3.0	40
1/2" NPT	1.5 - 3.0	54
3/4" NPT	1.5 - 3.0	78
1" NPT	1 - 2.5	112
1 1/4" NPT	1 - 2.5	154
1 1/2" NPT	1 - 2.5	211
2" NPT	1 - 2.5	300

Table 1

HELPFUL TIPS: AIR LINE AND FITTINGS

1. Minimum hose bend radius
 - 1/4" hose = 1" hose bend radius.
2. Hose to fitting
 - No side loading on fitting from hose.
 - Hose straight for 1" before bending.
3. Hose cutting
 - Cut hose perpendicular to hose length.
 - Inspect hose for scratches that run lengthwise on hose prior to insertion.
 - Use proper hose cutter, cigar cutter, or razor on flat surface.
4. DOT/SAEJ844 air brake hose data
 - Maximum working pressure of 175 PSI.
 - Not to be used for frame (body) to un-sprung mass connection, use a braided leader hose for this moving connection.

Compressor Tank Pressure		
Viair	Air Lift P/N	Max. Tank Pressure
380C	16380	175
400C	16400	150
444C	16444	175
450C	16450	150
480C	16480	175

Table 2

Installing the Air Management System

INSTALL COMPONENTS

NOTE For a complete installation diagram, see fig. 1. (pages 8-9)

Layout

1. Plan component location first.
2. Prior to mounting components, check to make sure:
 - the compressor leader hose will reach the tank.
 - the plumbing will route cleanly through the vehicle.

NOTE Be sure to install all components as far as possible from any heat sources. Plan and prepare wiring and plumbing routing through the vehicle. Eliminate all sharp edges that could chafe. Use grommets when passing through compartment walls.

Prepare and install the compressor

1. Prepare the compressor intake. If inside the vehicle, attach filter to port on end of compressor (fig. 1). If the compressor is located outside the vehicle, snorkel inlet filter to a dry location inside vehicle using components supplied with the compressor.
2. Center punch and drill four holes using the template on page 15.
3. Attach using the hardware supplied with the compressor.

NOTE Air compressors ingest moisture and will deposit water in the tank. Tanks must be regularly purged to eliminate the possibility of water freezing inside the system or causing corrosion. Be sure to provide easy access to drain/fill valve (preferably outside the vehicle). The system does not include moisture separators or water traps, and does require periodic tank moisture drain. If using an engine driven compressor, proper oil and water filtration must be added as these compressors will contaminate the air suspension system. Water traps are available and sold separately through Air Lift Performance, part numbers: 21011 (1/4"), 21012 (3/8"), 21013 (1/2").

Tank pre-assembly (see fig. 1)

1. Determine tank location and orientation prior to installing fittings.
2. Apply thread sealant as necessary to all fittings.
3. Install the drain/fill PTC fitting in the lower most tank threaded port.
4. Choose a tank threaded port for the compressor fitting.
5. Choose the highest tank threaded port for air line supply.
6. Plug any remaining tank ports with hex plugs.

Tank install (see fig. 1)

1. Using the tank feet as a template, drill holes for hardware assembly.
2. Attach the tank using the supplied hardware.
3. Cut an appropriate length of hose from the manifold port T, to the PTC fitting on the tank.
4. Route the drain/fill air line with a schrader valve (preferably outside the vehicle).

NOTE

When cutting plastic air line, only use a standard hose cutter like (Air Lift part number 10530) or razorblade. Cut all hose ends square and as smoothly as possible. See hose cutting tips on page 4.

MOUNTING THE SWITCH PANEL

Refer to the switch panel template on page 13.

1. Find a location to mount the paddle switch mounting bracket (E).
2. Snap all four paddle switches (D) into the paddle switch mounting bracket (E) so the DEL is toward the top.

NOTE

You may select different locations for the paddle switches. The paddle switches do not need to be used with the supplied paddle switch mounting bracket.

3. Cut six pieces of air line (F) the same length (approximately 3"-6").
4. Push four of these pieces onto the "SUP" port of the switch. Attach two Y fittings (II) to the air lines.
5. Push the other two pieces of line into the Y fittings (II).
6. Attach the last Y fitting (II) to the air lines.
7. Mount the paddle switch mounting bracket (E) with four screws (I).

ATTACHING THE AIR LINES



CAUTION

WHEN CUTTING OR TRIMMING THE AIR LINE, USE THE AIR LINE CUTTER (G). A CLEAN, SQUARE CUT WILL ENSURE AGAINST LEAKS. DO NOT USE WIRE CUTTERS OR SCISSORS TO CUT THE AIR LINE. THESE TOOLS MAY FLATTEN OR CRIMP THE AIR LINE, CAUSING IT TO LEAK.

1. Run a length of air line (F) from the air fitting on the compressor to the end of the switch cluster.
2. Run a length of air line from the remaining air fittings on the switch to its respective air spring.
3. Repeat step 2 for the remaining air fittings and air springs.
4. Use a tee and connect into each one of the air spring lines to connect to it's respective gauge port.
5. Test and make sure that the switches operate the appropriate air springs.

Troubleshooting Guide

For further technical assistance contact Air Lift customer service at (800) 248-0892, Monday through Friday. For calls from outside the USA or Canada, dial (517) 322-2144.

PROBLEM	CAUSE	SOLUTION
<i>Compressor doesn't run</i>	There is a blown fuse or relay, bad ground, or poor electrical connections.	Replace the fuse, check the ground wire, or check the compressor connector
<i>Compressor runs all the time.</i>	The compressor relay is defective or there is a leak.	Replace the relay or locate the leak and repair.
<i>Air spring or tank leak.</i>	Fitting seal or air line is compromised.	Check to make sure air lines are seated in connectors. Inspect fittings with soapy water. Trim hose or re-seal fitting.
<i>Compressors runs all the time but doesn't fill the tank.</i>	Compressor in-line check valve fitting has been overtorqued.	Loosen fitting and check again. Replace if needed.

Tuning the Air Pressure

Pressure determination comes down to three things — level vehicle, ride comfort, and stability.

1. Level vehicle

If the vehicle's headlights are shining into the trees or the vehicle is leaning to one side, then it is not level. Raise the air pressure to correct either of these problems and level the vehicle.

2. Ride comfort

If the vehicle has a rough or harsh ride it may be due to either too much pressure or not enough. Try different pressures to determine the best ride comfort.

3. Stability

Stability translates into safety and should be the priority, meaning the driver may need to sacrifice a perfectly level and comfortable ride. Stability issues include roll control, bounce, dive during braking and sponginess. Tuning out these problems usually requires an increase in pressure.

Leak Testing and Detection

Leak detection

1. A leak can be defined as a loss of pressure of more than 5 psi over an 8 hour period. Be aware that ambient temperature change has an effect on pressure that may seem like a leak. For example: a change of 10° Fahrenheit up or down from your baseline will have an approximate gain or loss of indicated pressure of 2 psi. If a leak is suspected after including any temperature change, then proceed to #2.
2. Spray soapy water (1/5 Dawn brand dish soap to 4/5 water) on suspect fittings and hose connections and look for any bubbling caused by air leakage.
3. Fix leaking connection (review pages 3 and 4 for help on NPT fittings and air line connections).
4. Wipe down sprayed connections with rag to remove any residual soapy water.

NOTE

Dawn brand dish soap will not corrode the metals (aluminum, brass, steel) with which it comes into contact.

Installation Diagram

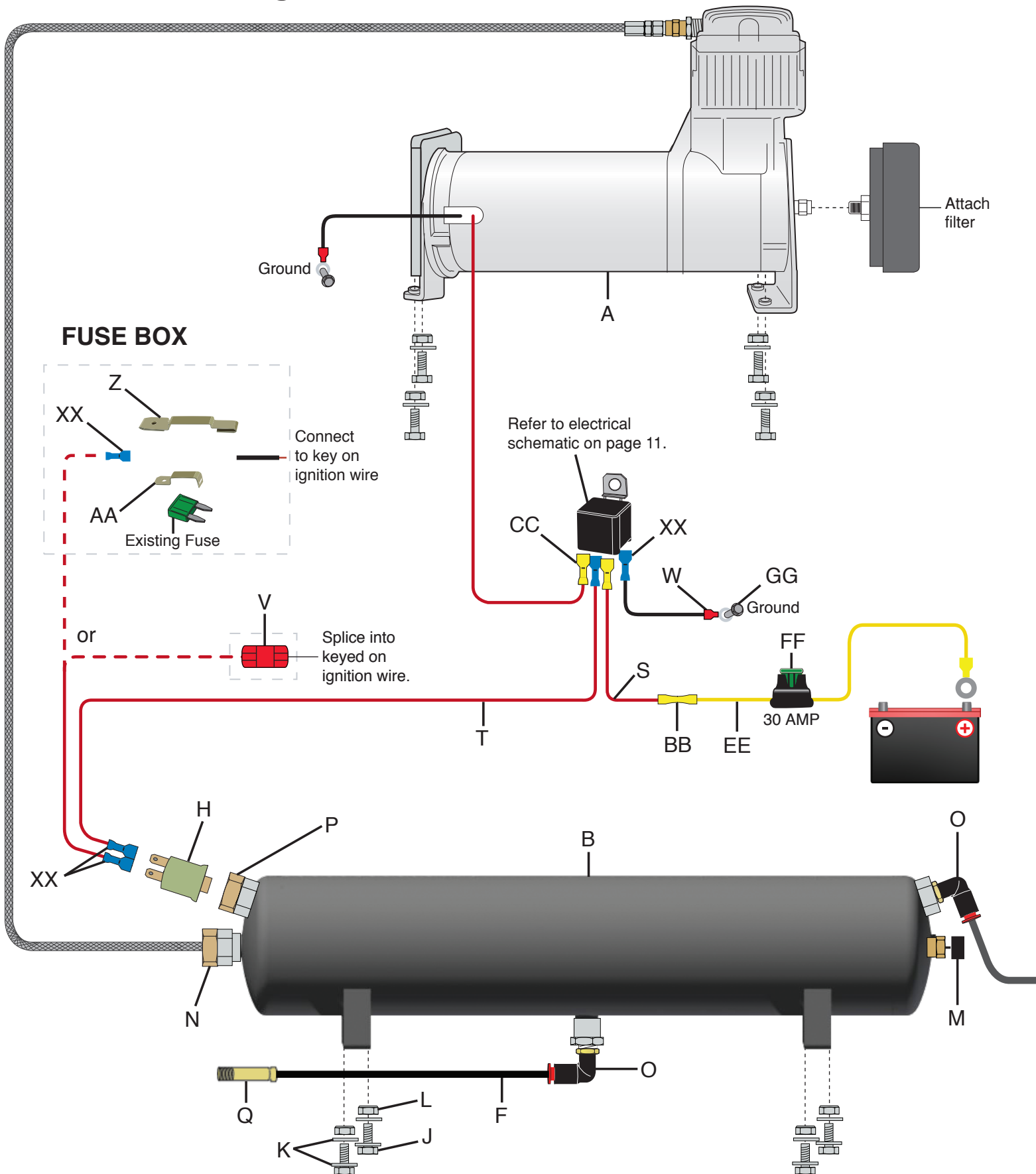

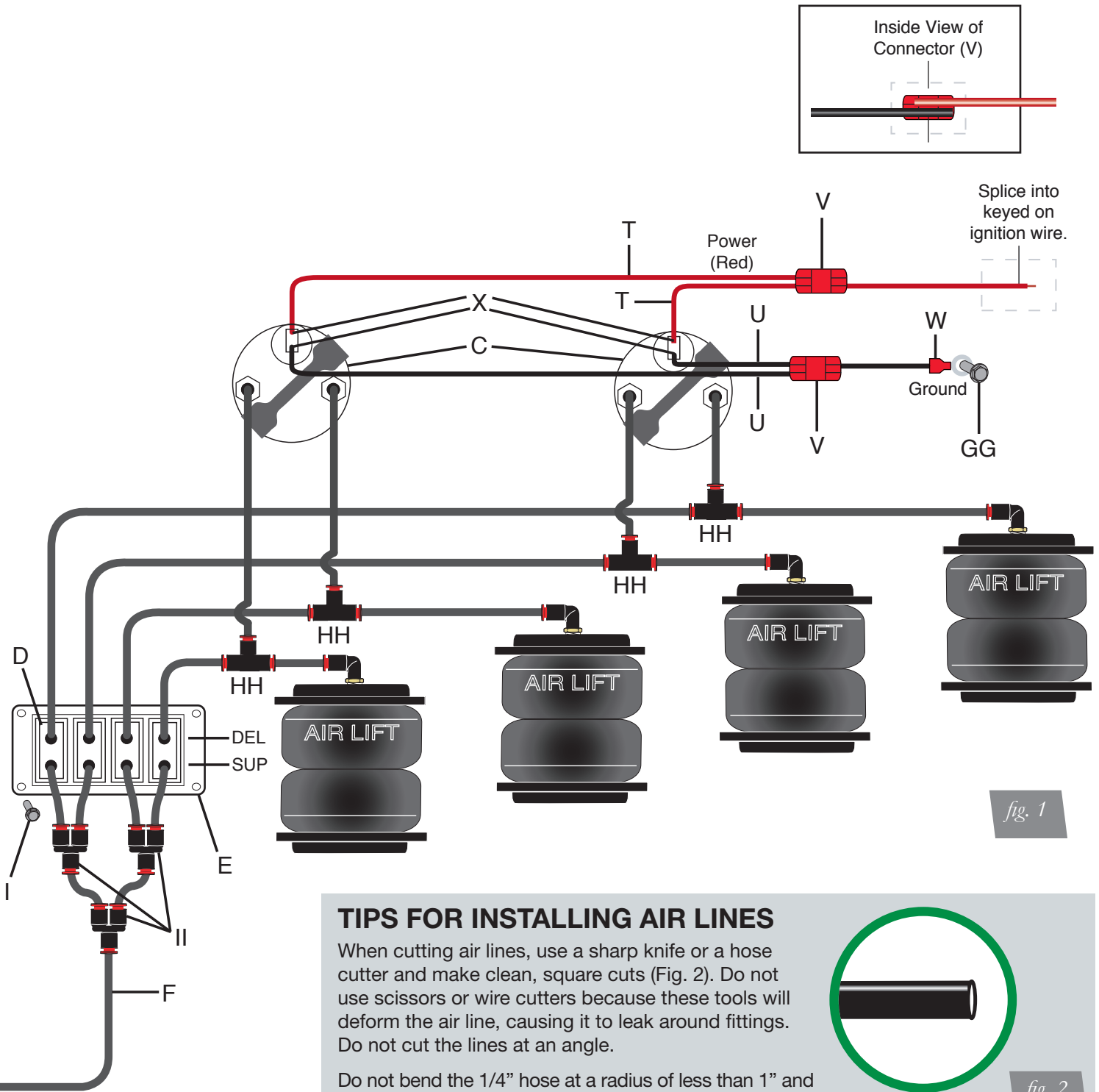

fig. 1

Drawing not to scale. Air bags are for reference only and are not included with air management system.

TIPS FOR INSTALLING AIR LINES

When cutting air lines, use a sharp knife or a hose cutter and make clean, square cuts (Fig. 2). Do not use scissors or wire cutters because these tools will deform the air line, causing it to leak around fittings. Do not cut the lines at an angle.

Do not bend the 1/4" hose at a radius of less than 1" and do not put side load pressure on fitting. The hose should be straight beyond the fitting for 1" before bending.

Inspect hose for scratches that run lengthwise on hose prior to installation. Contact Air Lift customer service at (800) 248-0892 if the air line is damaged.



To watch a video demonstrating proper air line cutting, go to air-lift.co/cuttingairline

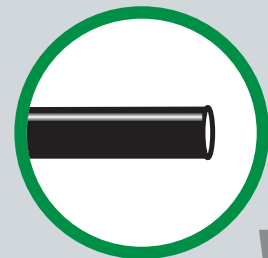

fig. 2



Notes

Electrical Schematic

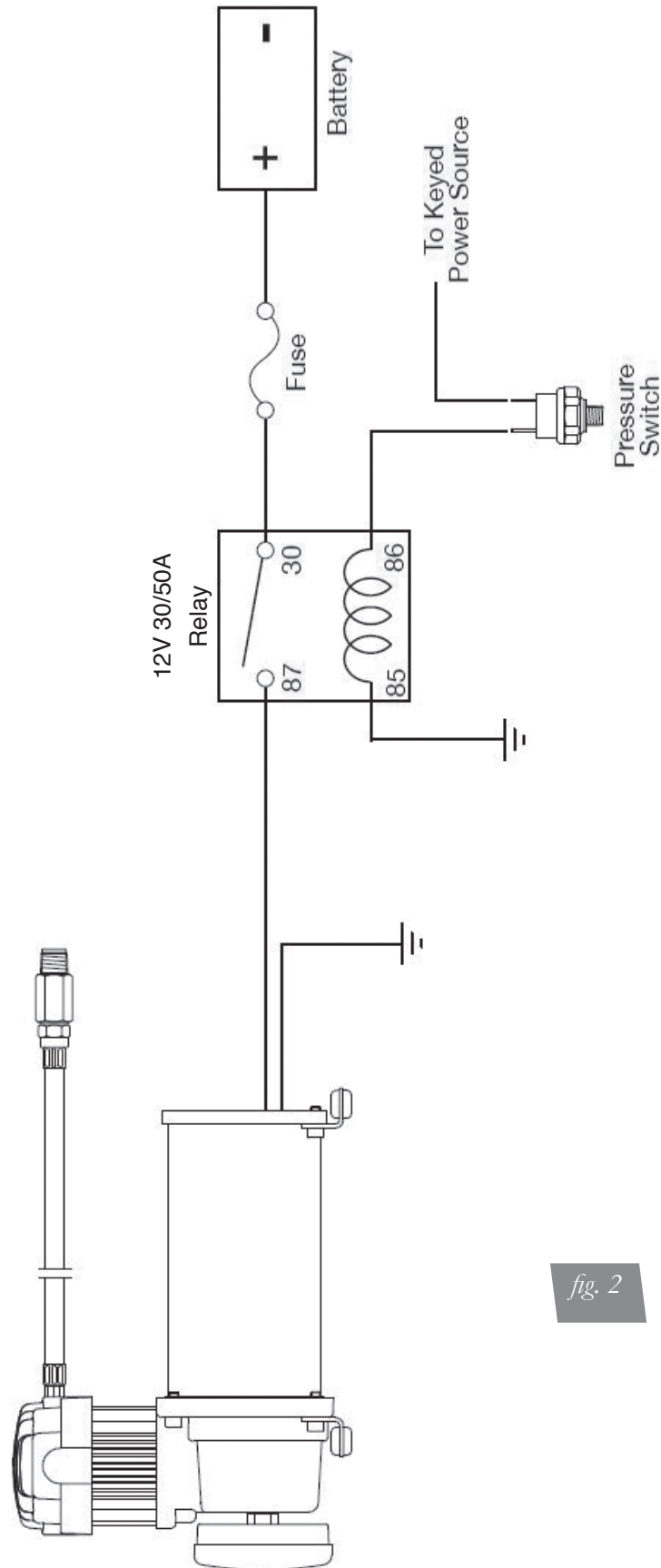

fig. 2

Notes

Paddle Switch Mounting Bracket Template

⚠ CAUTION

IMPORTANT: PRINT THIS MANUAL AT 100% SCALE. THIS MANUAL CONTAINS DRILLING TEMPLATES, WHICH WOULD BE RENDERED INCORRECT IN DIMENSION IF PRINTED WITH ANY SCALING. USING AN INCORRECT TEMPLATE TO DRILL HOLES MAY CAUSE DAMAGE TO YOUR VEHICLE.

REFER TO THE ONE-INCH SCALE (FIG. 3) AND USE A MEASURING TOOL TO CONFIRM THAT THE PRINTED SCALE MEASURES ONE INCH TO VERIFY PROPER SCALE. IF THIS IS PRINTED AT ANY SCALE OTHER THAN 100%, THE INSTALLER COULD END UP DRILLING IN THE WRONG LOCATIONS ON THE VEHICLE.

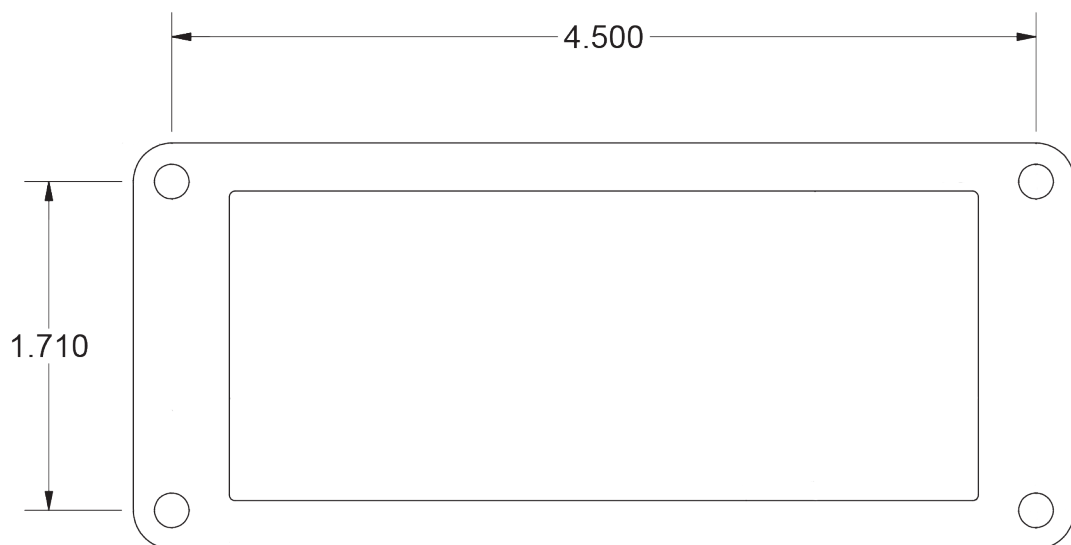
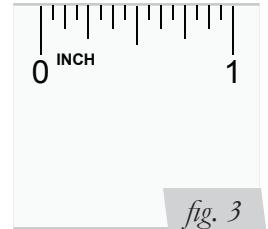

Notes

16380 Compressor Template

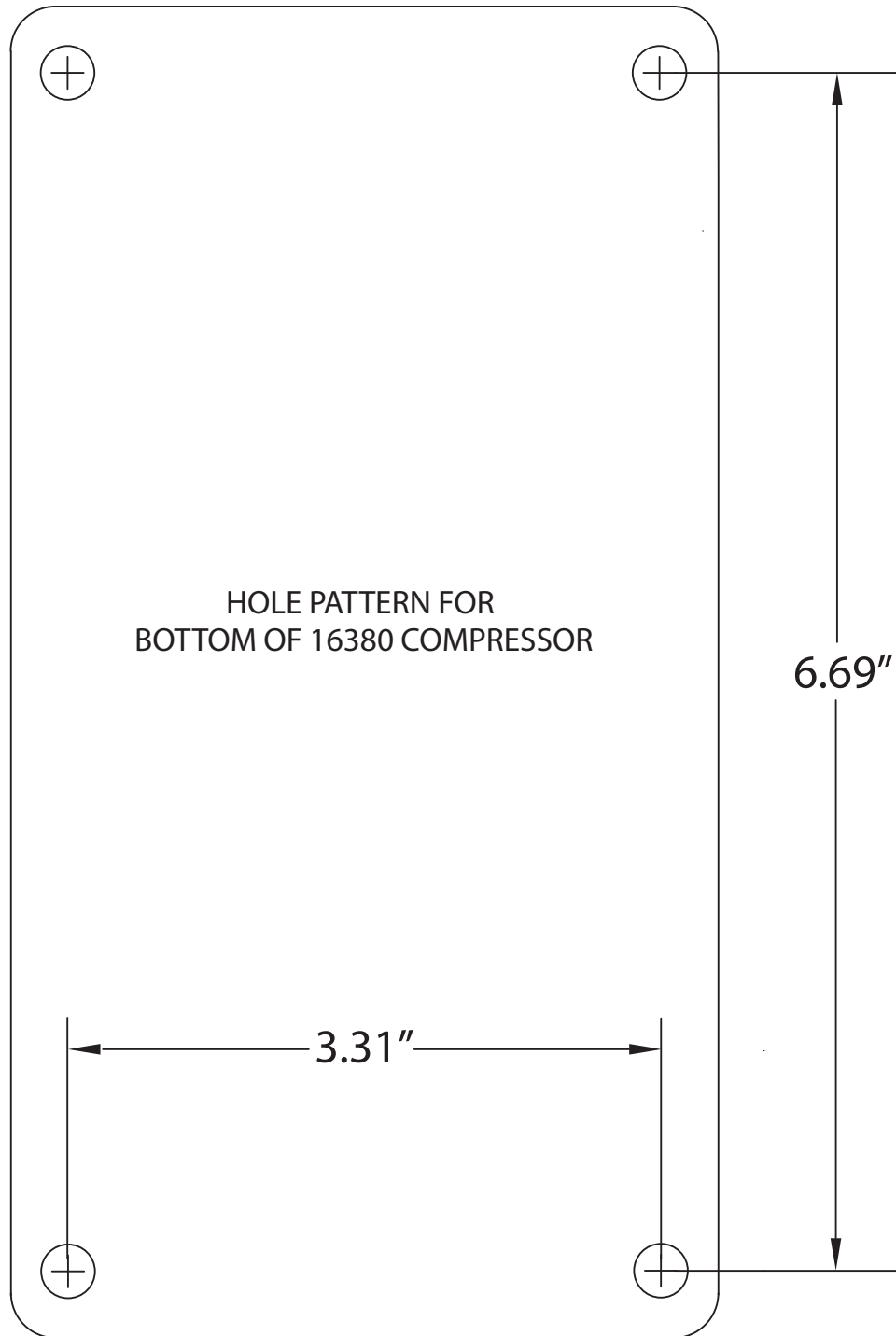

Limited Warranty and Return Policy

WHAT THIS WARRANTY COVERS

Air Lift Company, for all Air Lift Performance products, except its Air Lift Performance 3H™ and 3P™ systems, warrants to the original purchaser for a period of one year from the date of original purchase that the Air Lift Performance damper kits will be free from defects in workmanship and materials for the normal expected life of the part when used on cars and trucks as specified by Air Lift Company and under normal operating conditions, subject to the requirements and exclusions set forth below.

Air Lift Company provides a Limited Lifetime Warranty to the original purchaser of its Air Lift Performance 3H™ and 3P™ Control/Air Management Systems, that the Air Lift Performance products will be free from defects in workmanship and materials for the normal expected life of the part when used on cars and trucks as specified by Air Lift Company and under normal operating conditions, subject to the requirements and exclusions set forth below.

WHAT THIS WARRANTY DOES NOT COVER

The warranty does not apply to products that have been improperly applied, improperly installed, or which have not been maintained in accordance with installation instructions furnished with all products. This warranty does not apply and is void if damage or failure is caused by: accident, abuse, misuse (including but not limited to racing or off-road activities or commercial use), abnormal use, faulty installation, liquid contact, fire, earthquake or other external cause; operating the product outside Air Lift Company's instructions, specifications or guidelines; or service, alteration, maintenance or repairs performed by anyone other than Air Lift Company to the product from its purchased condition. This warranty also does not apply to: Universal Air (Fabricator Kits), consumable parts, such as batteries; cosmetic damage, including but not limited to scratches or dents; defects caused by normal wear and tear or otherwise due to the normal aging of the product, or if any serial or identification number has been removed or defaced from the product. Air Lift Company reserves the right to change the design of any product without assuming any obligation to modify any product previously manufactured.

LIMITATION OF LIABILITY

To the extent permitted by law, this warranty and the remedies set forth herein are exclusive and in lieu of all other warranties, remedies and conditions, whether oral, written, statutory, express or implied. AIR LIFT COMPANY DISCLAIMS ALL STATUTORY AND IMPLIED WARRANTIES, INCLUDING WITHOUT LIMITATION, WARRANTIES OF MERCHANTABILITY AND FITNESS FOR A PARTICULAR PURPOSE AND WARRANTIES AGAINST HIDDEN OR LATENT DEFECTS TO THE EXTENT PERMITTED BY LAW. To the extent such warranties cannot be disclaimed, such implied warranties shall apply only for the warranty period specified above. Please note that some states do not allow limitation on how long an implied warranty (or condition) lasts. So the above limitation may not apply to you.

Except as provided in this warranty and to the extent permitted by law, Air Lift Company shall not be liable for any direct, special, incidental or consequential damages resulting from any breach of warranty or condition, or arising in connection with the sale, use or repair of air lift products, or under any other legal theory, including but not limited to loss of use, loss of revenue, loss of actual or anticipated profits, loss of the use of money, loss of business, loss of opportunity, loss of goodwill, and loss of reputation. Air Lift Company's maximum liability shall not in any case exceed the purchase price paid by you for the Air Lift product. Please note that some states do not allow the exclusion or limitation of incidental or consequential damages, so the above limitation or exclusion may not apply to you.

HOW TO GET SERVICE

If a defect in workmanship or materials causes your Air Lift Performance product to become inoperable within the warranty period, before returning any defective product, call Air Lift Company at (800) 248-0892 in the U.S. and Canada (elsewhere, (517) 322-2144) to obtain a Returned Materials Authorization (RMA) number. The consumer shall be responsible for removing (labor charges) the defective product from the vehicle and returning it, shipping costs prepaid, to Air Lift Company for verification. Returns to Air Lift Company must be postage prepaid and sent to: Air Lift Company • 2727 Snow Road • Lansing, MI • 48917. You must prove to the satisfaction of Air Lift Company the date of original purchase of your Air Lift Performance product. You must also enclose the RMA number and a return address. A minimum \$10 shipping and handling charge will apply to all warranty claims. You must also pack the product to minimize the risk of it being damaged in transit. If we receive a product in damaged condition as the result of shipping, we will notify you and you must seek a claim with the shipper.

WHAT AIR LIFT COMPANY WILL DO

If you submit a valid claim to Air Lift Company during the warranty period, Air Lift Company will, at its option, repair your Air Lift Performance product or furnish you with a new or rebuilt product. Air Lift Company will not reimburse you for repairs or replacement parts provided by other parties. Your repaired or replacement Air Lift Performance product will be returned to you (subject to payment of the required warranty claim shipping and handling charge) and it will be covered under the warranty for the balance of the warranty period, if any. When a product or part is replaced, any replacement item becomes your property and the replaced item becomes property of Air Lift Company. You are responsible for installation/reinstallation (labor charges) of the product.

HOW THE LAW RELATES TO THIS WARRANTY

This warranty gives you specific legal rights and you may also have other rights which vary from state to state. By this warranty, Air Lift Company does not limit or exclude your rights except as allowed by law. To fully understand your rights, you should consult the laws of your state.

Replacement Part Information

If replacement parts are needed, contact the local dealer or call Air Lift customer service at **(800) 248-0892**. Most parts are immediately available and can be shipped the same day.

Contact Air Lift Company customer service at (800) 248-0892 first if:

- Parts are missing from the kit.
- Need technical assistance on installation or operation.
- Broken or defective parts in the kit.
- Wrong parts in the kit.
- Have a warranty claim or question.

Contact the retailer where the kit was purchased:

- If it is necessary to return or exchange the kit for any reason.
- If there is a problem with shipping if shipped from the retailer.
- If there is a problem with the price.

Contact Information

Mailing address	P.O. Box 80167 Lansing, MI 48908-0167
Shipping address for returns	2727 Snow Road Lansing, MI 48917
Phone	Toll free: (800) 248-0892 International: (517) 322-2144
Email	service@airliftcompany.com
Web address	www.airliftcompany.com

Need Help?

Contact our customer service department by calling (800) 248-0892. For calls from outside the USA or Canada, dial (517) 322-2144.



Thank you for purchasing Air Lift Performance products!

Air Lift Performance • 2727 Snow Road • Lansing, MI 48917 or P.O. Box 80167 • Lansing, MI 48908-0167
Toll Free (800) 248-0892 • Local (517) 322-2144 • Fax (517) 322-0240 • www.airliftperformance.com

Printed in
the USA