



Equipped with AEM® DRYFLOW Filter  
No Oil Required!

## **INSTALLATION INSTRUCTIONS**

### **PART NUMBER: 24-6033**

---

2000-2005 MITSUBISHI Eclipse L4-2.4L Manual Trans. C.A.R.B. E.O. # D-670-6

**AEM® bypass valves are not compatible with this intake system (part number 24-6033)**  
**DO NOT attempt to install an AEM bypass valve on this intake system.**

**\* NOTE: Legal in California only for racing vehicles which may never be used upon a highway**

**PARTS LIST**

<b>Description</b>	<b>Qty.</b>	<b>Part Number</b>
Upper Pipe	1	2-60331
Lower Pipe	1	2-60332
Adaptor,MAF Mitsu.	1	2-606
Hose; 3/8"ID x 7"L	1	5-1007
Nut, M6 Hex Serrated	5	444.460.04
Washer, 6mm Soft Mount	2	08160
Mount, Rubber 1" x 6mm	1	1228599
Bolt, Hex M6 x 1.0 x 16mm	1	1-2030
Hose, Silicone 2.75x3" blk	1	5-275
Elbow, 2.75-90 3.4"& .9"	1	5-280
Hose, Adapter 2.75/3.00 x 3"	1	5-273
1/2" Bnd. Hose Clamp,2.90"-3.75"	1	9452
1/2" Bnd. Hose Clamp,2.31-3.25"	5	9444
Bolt, Socket M6-1 x 30mm	4	1-2020
A/F Assy 3.50 x 5" Dry Ele.	1	21-204DK
1/2" Bnd. Hose Clamp,3.15"-4.00"	1	9456

Read and understand these instructions **BEFORE** attempting to install this product. Failure to follow installation instructions and not using the provided hardware may damage the intake tube, throttle body and engine.

The AEM® intake system is a performance product that can be used safely during mild weather conditions. During harsh and inclement weather conditions, you must return your vehicle to stock OEM air box and intake tract configuration. Failure to follow these instructions will void your warranty.

## 1. Preparing Vehicle

- a. Make sure vehicle is parked on level surface.
- b. Set parking brake.
- c. If engine has run in the past two hours, let it cool down.
- d. Disconnect negative battery terminal.
- e. Raise the front of the vehicle with a jack. Refer to your owner's manual for proper jack and jack stand placement to properly support vehicle. Support your vehicle using properly rated jack stands before wheel removal or while working under the vehicle. **NEVER WORK UNDER A VEHICLE WITHOUT USING JACK STANDS.**
  - i. Remove the front driver side wheel.
  - ii. Remove driver side fender liner.
- f. Do not discard stock components after removal of the factory system.

## 2. Removal of Stock System

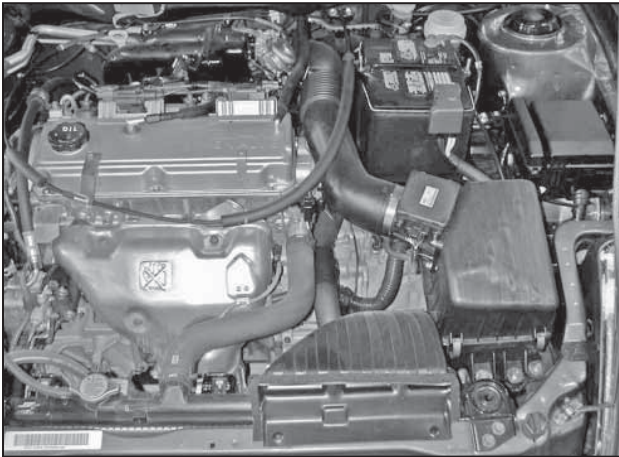

a. Factory air box system installed.

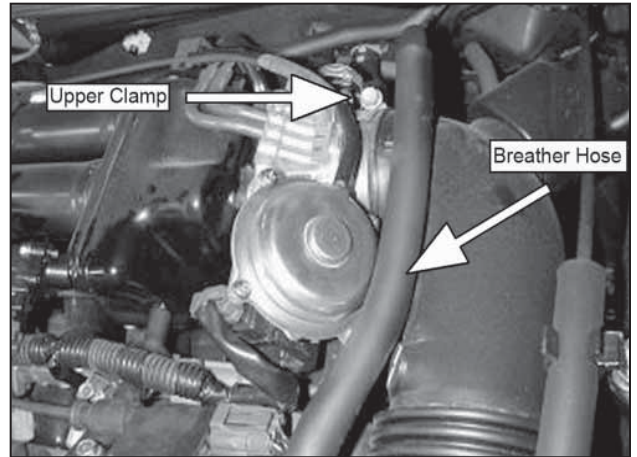

b. Pull the breather hose off the valve cover. Loosen the upper and lower hose clamps on the stock inlet tube.

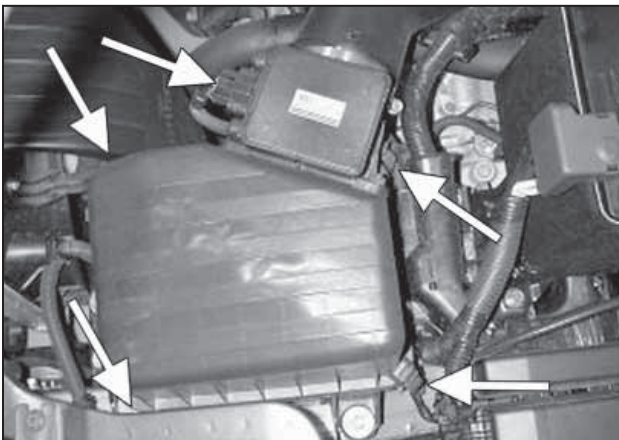

c. Unplug the MAF sensor. Remove the stock inlet tube. Release the four clamps on the air box and then remove the upper air box from the vehicle.

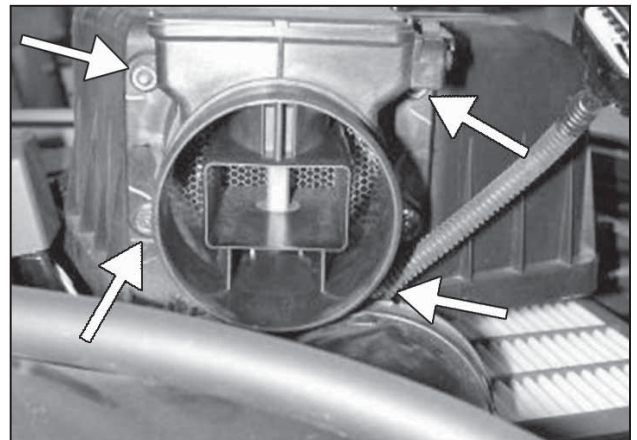

d. Loosen the four nuts that secure the MAF sensor to the air box. Carefully remove and set aside the MAF sensor.

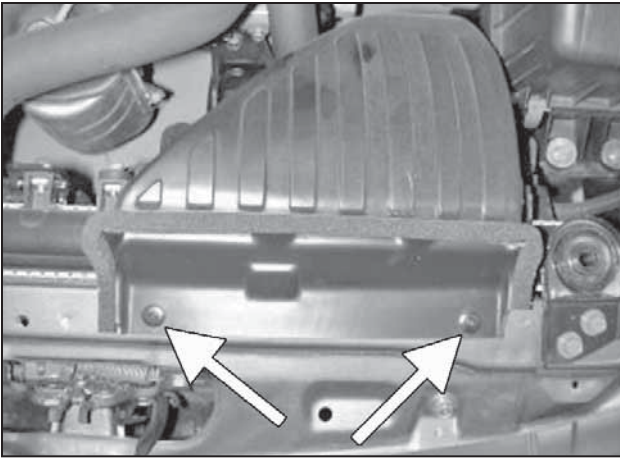

e. Release the air duct by removing the plastic rivets (Push in the center of the plastic rivet to remove).

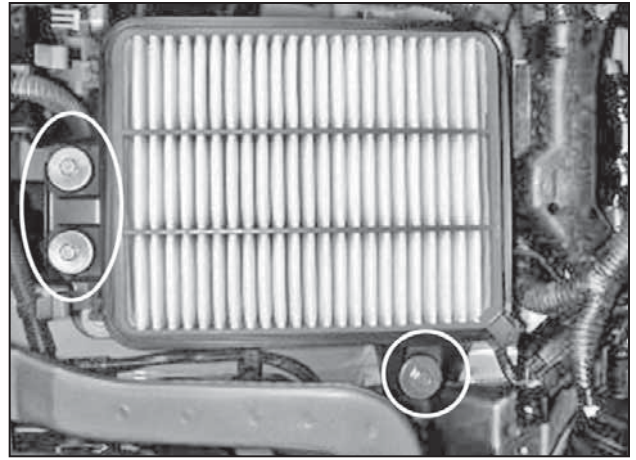

f. Loosen the three bolts securing the air box. Remove the air box and duct from the vehicle.

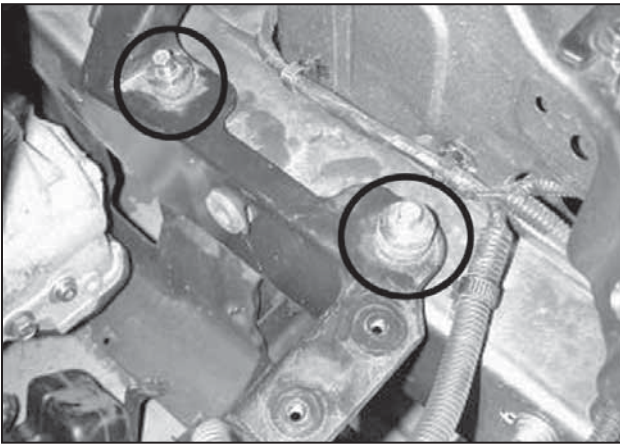

g. Remove the lower mounting bracket.

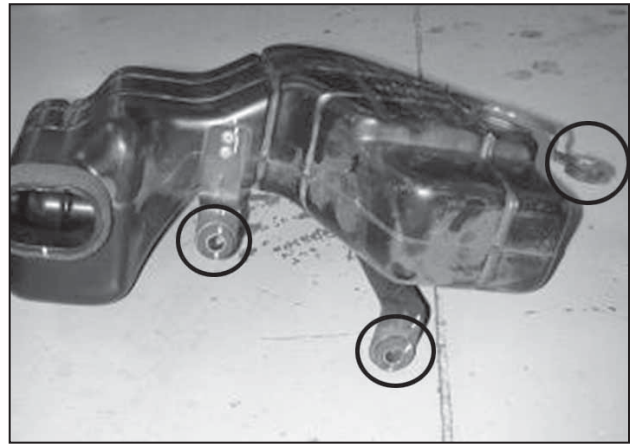

h. Loosen the three bolts that secure the lower air box and remove it from the vehicle.

### 3. Installation of AEM® intake system.

a. When installing the intake system, do not completely tighten the hose clamps or mounting hardware until instructed to do so.

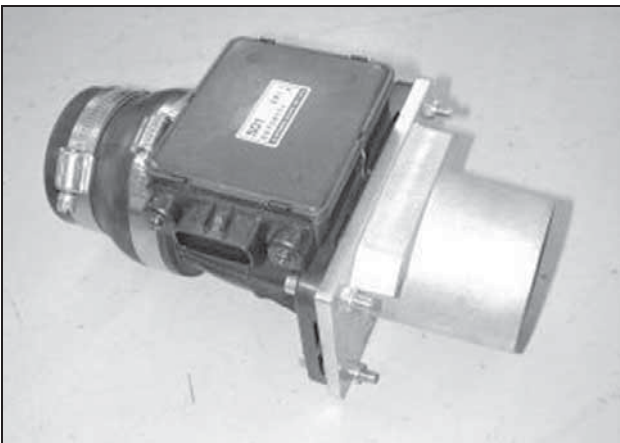

b. Attach the MAF adapter to the MAF sensor using the supplied bolts and lock nuts.

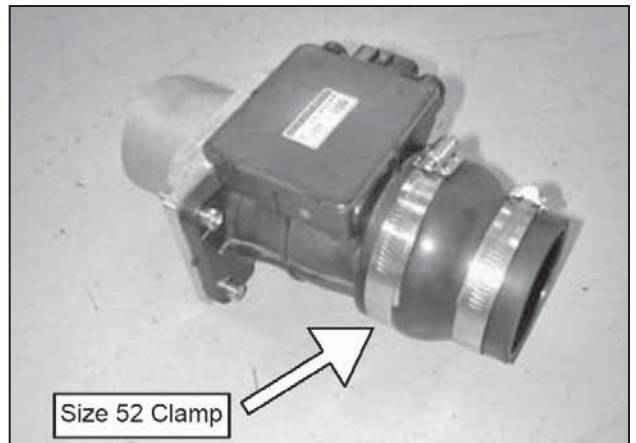

c. Attach the coupler to the MAF sensor using the provided hose clamps.

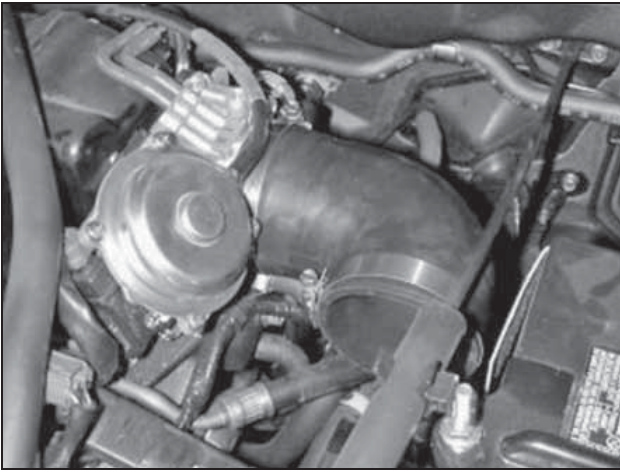

d. Place the rubber elbow with two hose clamps onto the throttle body. The longer end attaches to the throttle body.

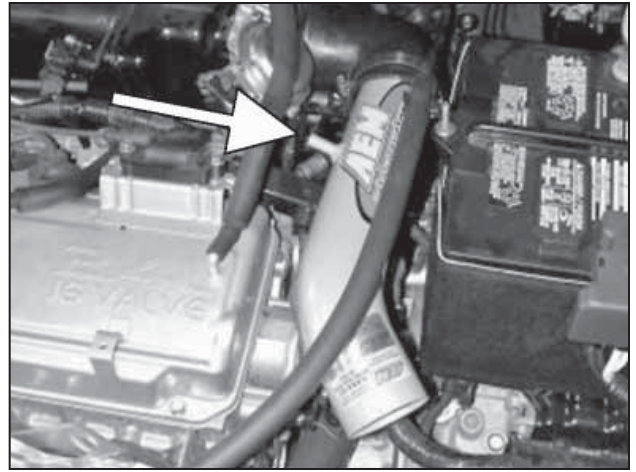

e. Insert the upper AEM® intake pipe into the rubber elbow. Ensure that the nipple of the intake pipe is facing the valve cover.

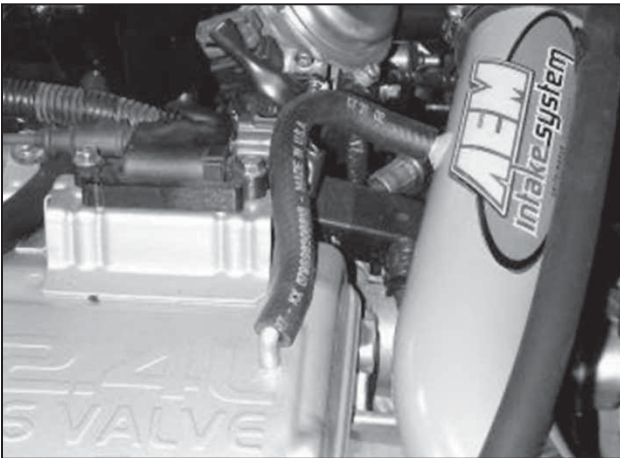

f. Install the supplied breather hose; secure both ends with the supplied  $\frac{3}{4}$ " hose clamps.  
**NOTE: Trim the breather hose if necessary for proper fitment.**

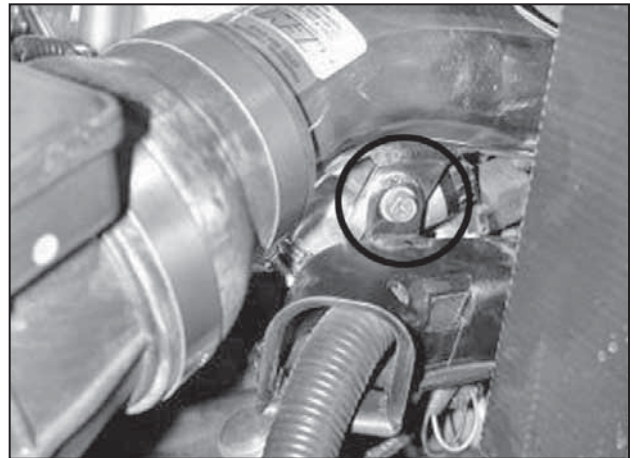

g. Place the intake pipe's bracket behind the specified stock plastic tab. Attach the bracket of the upper intake pipe to the engine, using the supplied 6mm bolt and washer as shown. Once secured, install the MAF sensor assembly onto the intake pipe; secure the side with the rubber coupler to the intake pipe.

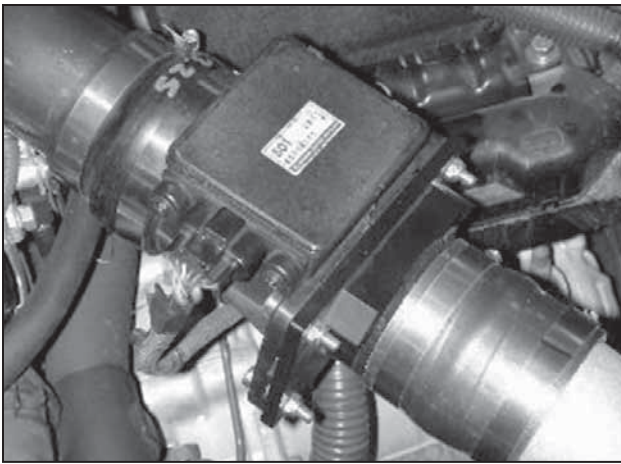

h. Plug the wiring harness into the MAF sensor. Install the straight coupler and hose clamps onto the upper section of the lower intake pipe. Guide the intake pipe into the engine bay, then attach the coupler to the MAF sensor. Secure the hose clamps, but do not completely tighten.

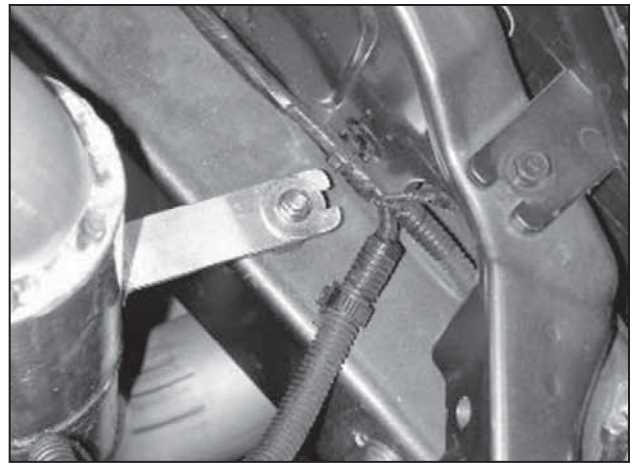

i. Install the rubber mount into the frame of the vehicle as shown. Align the lower intake pipe's bracket with the rubber mount and secure with a washer and lock nut. Do not completely tighten the lock nut. Refer to the diagram below to reference the proper installation of the rubber mount assembly.

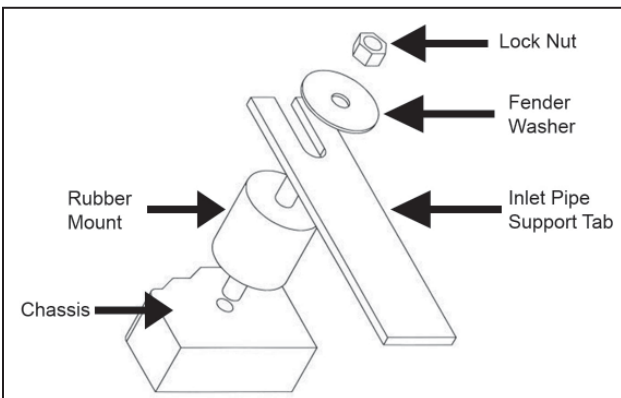

j. Proper installation of the rubber mount.

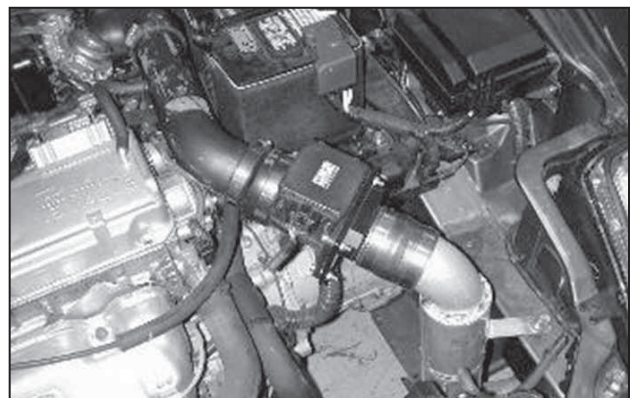

k. Install the air filter onto the lower end of the intake pipe. Once proper fitment and clearance is achieved, secure the air filter with the supplied hose clamp.

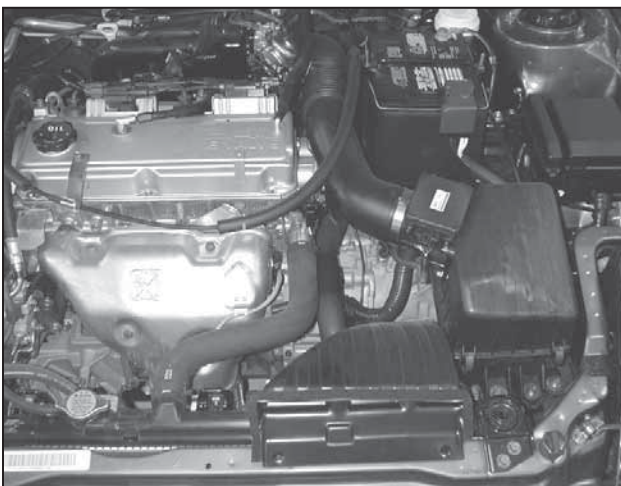

Factory air box system installed

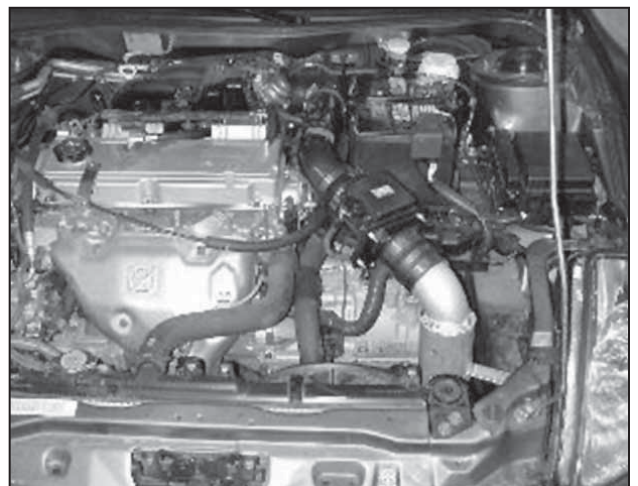

AEM® intake system installed

#### 4. Reassemble Vehicle

- a. Fender liner: Install the fender liner and any hardware that was removed in steps 1eii.  
**NOTE: Failure to install the fender liner will result in diminished performance and increase the potential for engine damage due to water ingestion in rainy conditions.**
- b. Wheel: Install the driver's side wheel using the factory torque specification (see owner's manual).
- c. Position the inlet pipes for the best fitment. Be sure that the pipes or any other components do not contact any part of the vehicle. Tighten the rubber mount, all bolts, and hose clamps.
- d. Check for proper hood clearance. Re-adjust pipes if necessary and re-tighten them.
- e. Inspect the engine bay for any loose tools and check that all fasteners that were moved or removed are properly tightened.
- f. Reconnect the negative battery terminal and start engine. Let the vehicle idle for 3 minutes. Perform a final inspection before driving the vehicle.
- g. Please note that AEM® bypass valves will not work with this application (part number 24-6033). The use of a bypass valve could have adverse effects on the performance of the system.

#### 5. CARB Sticker Placement

- a. The C.A.R.B. exemption sticker, (attached), must be visible under the hood so that an emissions inspector can see it when the vehicle is required to be tested for emissions. California requires testing every two years, other state may vary.

#### 6. Service and Maintenance

- a. AEM Induction Systems requires cleaning the intake system's air filter element every 100,000 miles. When used in dusty or off-road environments, our filters will require cleaning more often. We recommend that you visually inspect your filter once every 25,000 miles to determine if the screen is still visible. When the screen is no longer visible some place on the filter element, it is time to clean it. To clean, purchase our Synthetic air filter cleaner, part number 99-0624 and follow the easy instructions.
- b. Use window cleaner to clean your powder coated AEM® intake tube.  
**NOTE: DO NOT USE aluminum polish on powder coated AEM® intake tubes.**

For technical inquiries  
e-mail us at  
sales@aemintakes.com  
or  
call us at  
800.992.3000

#### AEM Air Intake System Warranty Policy

AEM® warrants that its intake systems will last for the life of your vehicle. AEM will not honor this warranty due to mechanical damage (i.e. improper installation or fitment), damage from misuse, accidents or flying debris. AEM will not warrant its powder coating if the finish has been cleaned with a hydrocarbon-based solvent. The powder coating should only be cleaned with a mild soap and water solution. Proof of purchase of both the vehicle and AEM intake system is required for redemption of a warranty claim.

This warranty is limited to the repair or replacement of the AEM part. In no event shall this warranty exceed the original purchase price of the AEM part nor shall AEM be responsible for special, incidental or consequential damages or cost incurred due to the failure of this product. Warranty claims to AEM must be transportation prepaid and accompanied with dated proof of purchase. This warranty applies only to the original purchaser of product and is nontransferable. Improper use or installation, use for racing, accident, abuse, unauthorized repairs or alterations voids this warranty. AEM disclaims any liability for consequential damages due to breach of any written or implied warranty on all products manufactured by AEM. Warranty returns will only be accepted by AEM when accompanied by a valid Return Merchandise Authorization (RMA) number. Credit for defective products will be issued pending inspection. Product must be received by AEM within 30 days of the date RMA is issued.

If you have a warranty issue, please call (800) 992-3000 and our customer service department will assist you. A proof of purchase is required for all AEM warranty claims.