



Equipped with AEM® Dryflow™ Filter
No Oil Required!

INSTALLATION INSTRUCTIONS

PART NUMBER:

21-722C

(Gun Metal Grey Finish)

21-722P

(Vacuum Metalized Chrome - VMC)

2013-2014

DODGE

DART

1.4L I-4

C.A.R.B. E.O. # D-670-21

PARTS LIST

	Description	Qty.	Part Number
A	TUBE, UPPER, INTAKE	1	2-1507C/P
B	TUBE, LOWER, INTAKE	1	2-1508C/P
C	FILTER, DRYFLOW, 3.00"ID X 5"L	1	21-203DK
D	HOSE; 2-3/4"-2"ID X 3"L TPRD, REINFORCED	1	5-1045
E	HOSE; 2.75/3.00" X 3.00" HUMP	1	5-573
F	1/2" BNDHOSE CLAMP, 2.90-3.75", #52	1	9452
G	1/2" BNDHOSE CLAMP, 2.56-3.5", #48	1	9448
H	1/2" BNDHOSE CLAMP, 2.31-3.25", #44	2	9444
I	1/2" BNDHOSE CLAMP, #32	1	08507
J	VENT; STRT, 3/16 BARBED 1/4" NPT	1	080021
K	MOUNT, RUBBER, M6 X 1"L	1	1228599
L	WASHER, FLAT, M6 X 1"OD	2	08160
M	NUT, HEX FLANGED, SERR., M6	2	444.460.04

Kit Illustration

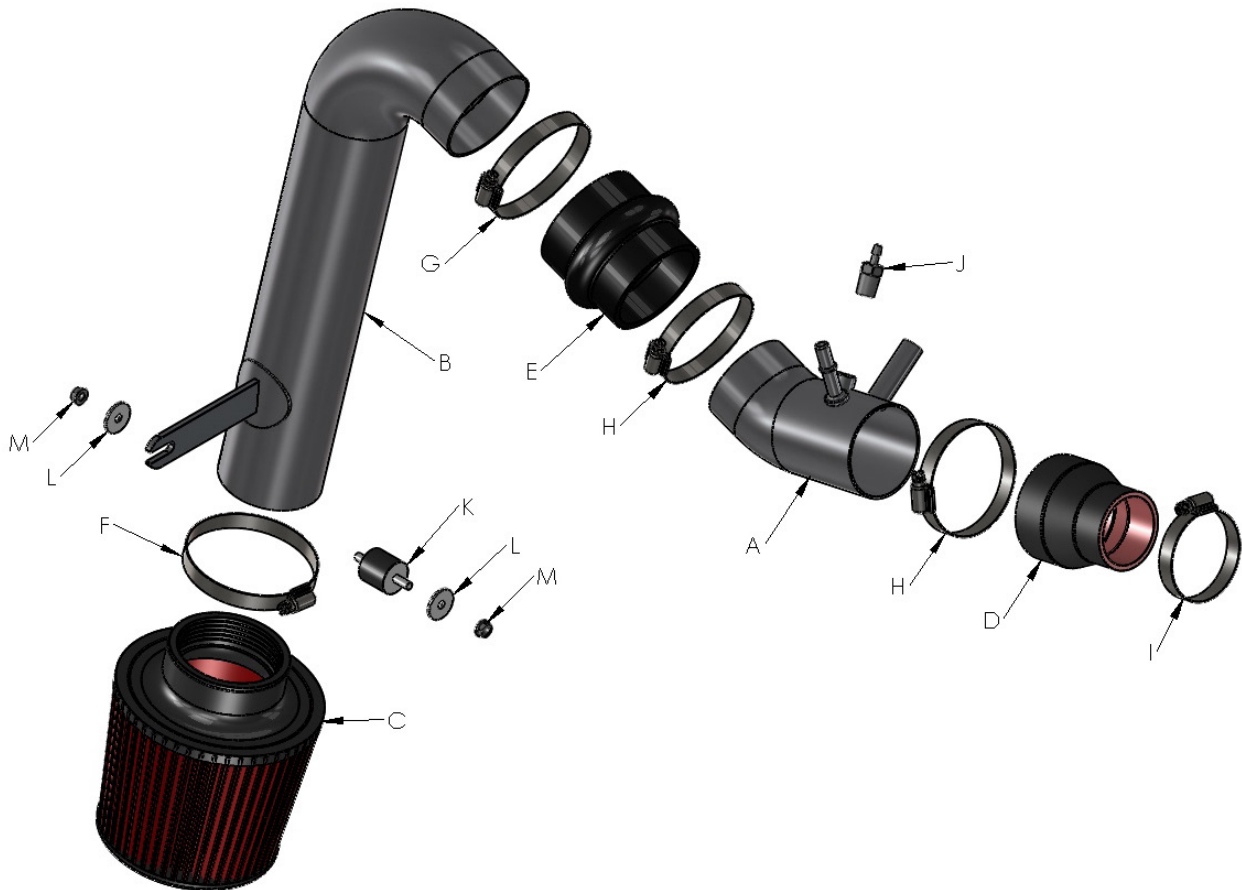

Read and understand these instructions **BEFORE** attempting to install this product. Failure to follow installation instructions and not using the provided hardware may damage the intake tube, throttle body and engine.

The AEM® intake system is a performance product that can be used safely during mild weather conditions. During harsh and inclement weather conditions, you must return your vehicle to stock OEM airbox and intake tract configuration. Failure to follow these instructions will void your warranty.

1. Preparing Vehicle

- a. Make sure vehicle is parked on level surface.
- b. Set parking brake.
- c. If engine has run in the past two hours, let it cool down.
- d. Disconnect negative battery terminal.
- e. Raise the front of the vehicle with a jack. Refer to your owner's manual for proper jack and jack stand placement to properly support vehicle. Support your vehicle using properly rated jack stands before wheel removal or while working under the vehicle.

NEVER WORK UNDER A VEHICLE WITHOUT USING JACK STANDS.

- . Do not discard stock components after removal of the factory system.

2. Removal of stock intake system



a. Remove the engine cover if equipped. Remove the M6 bolt at the air box mounting flange.

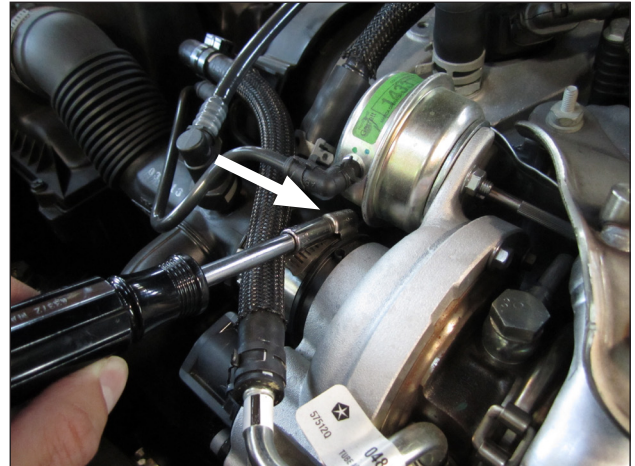

b. Loosen the hose clamp on the intake tube at the turbocharger inlet.



c. Disconnect the quick-release vacuum port at the stock intake tube by squeezing the gray tabs.

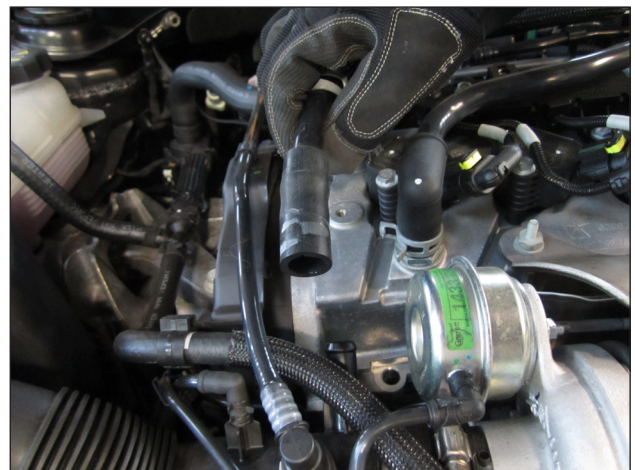

d. Disconnect the breather hose.

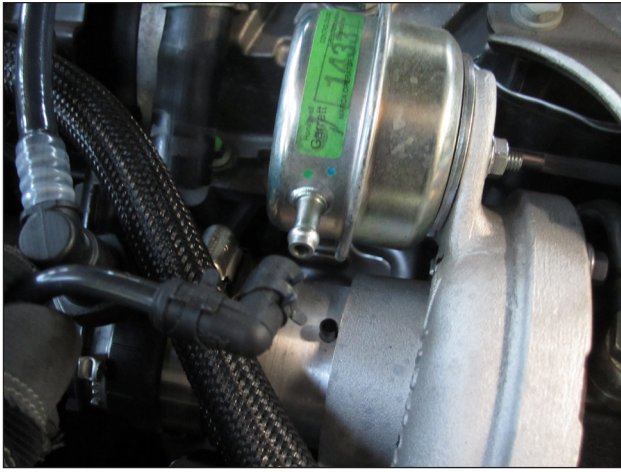

e. Disconnect the vacuum line elbow from the wastegate actuator at the turbocharger.

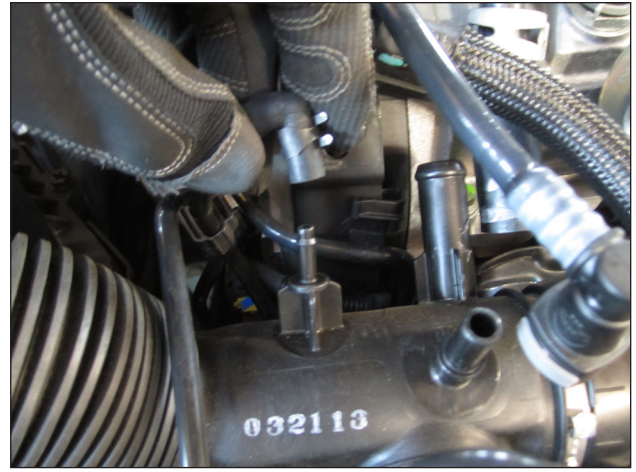

f. Disconnect the secondary vacuum line elbow from the intake tube.

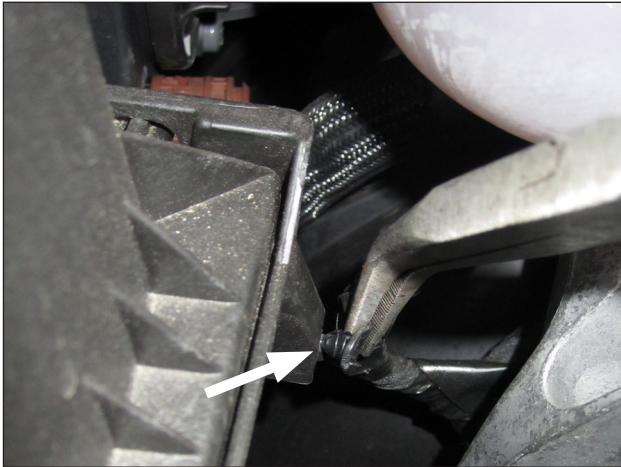

g. Remove the clip holding the wiring harness to the back of the air box with pliers.



h. Carefully remove the upper intake tube and air box assembly from the engine compartment.



i. Remove the 8 clips holding the vanity cover over the radiator core support.



j. To remove the clips, lift the center with a flathead screwdriver to unlock them, then remove the clip.

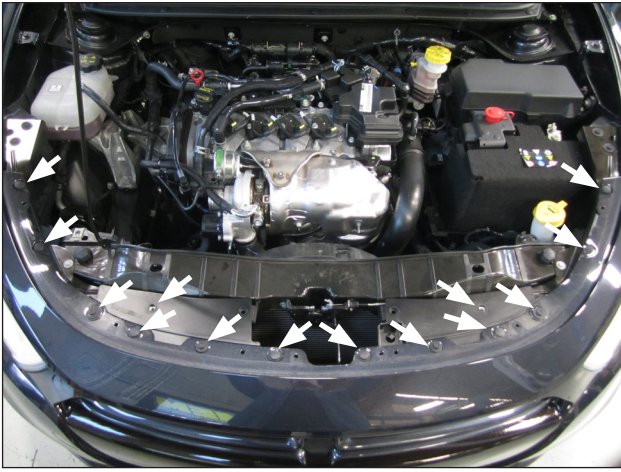

k. Next, remove the 8 clips and 6 bolts that hold the bumper cover onto the radiator core support.



i. Remove the 2 M6 bolts, 1 under each front wheel well at the edge of the front bumper cover.



m. Using an 8mm socket remove 10 bolts: 5 along the edge of the right front wheel liner, and 5 along the edge of the left wheel liner.



n. Remove the 8 bolts around the lower edge of the front bumper.

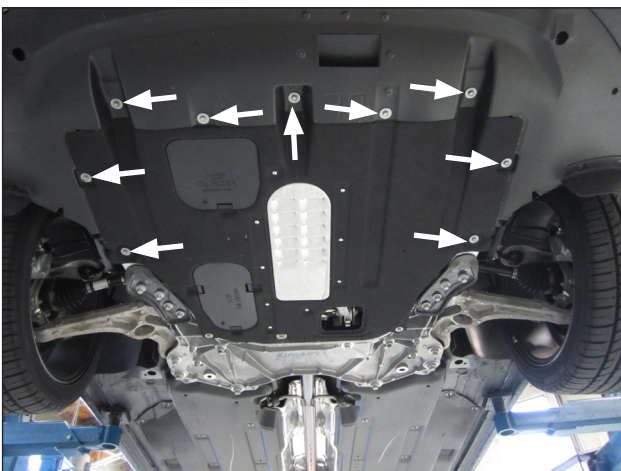

o. Remove the 9 M6 bolts around the front and side edges of the belly pan. Do not remove the belly pan.

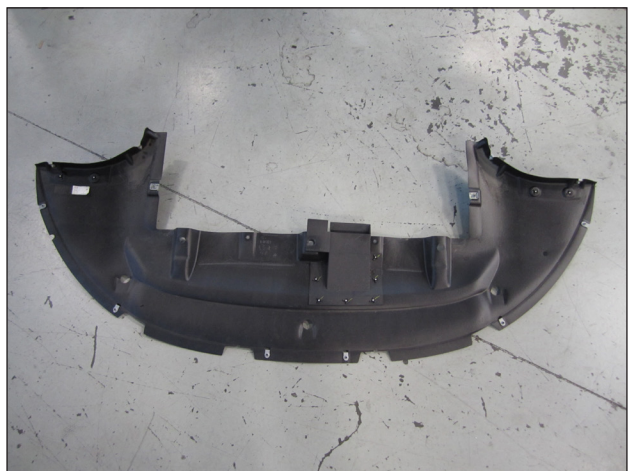

p. Remove the underside splash guard from between the front bumper cover and the belly pan.



q. Under the radiator, unlock and disconnect the wiring harness for the motorized shutter grill. Also disconnect the foglamp harnesses if so equipped.

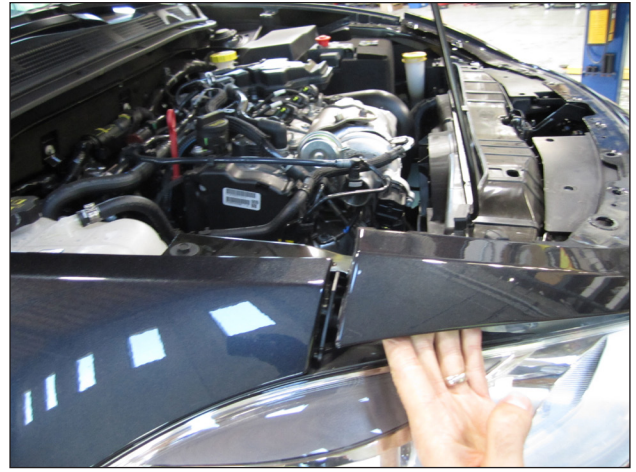

r. Carefully pull up at top edges of the front bumper cover above each headlight to unlock it.



s. Carefully pull up at the ends of the bumper cover just behind each headlight to unlock it.



t. Carefully pull at the rear edges of the bumper cover to unlock it from beneath each headlight.



u. Pull up on the top edges of the front bumper cover to unlock and remove it.

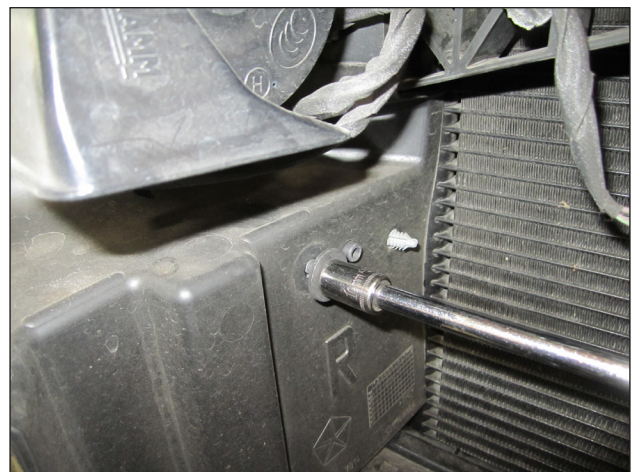

v. Remove the bolt in right side of the radiator shroud that retains the lower inlet tube.



w. Remove the clip holding the lower inlet tube bracket to the outside of the right radiator support.



x. Remove the lower inlet tube and resonator assembly from the intake mounting bracket.



y. Remove or cut the clip holding the heater tube to the intake mounting bracket.

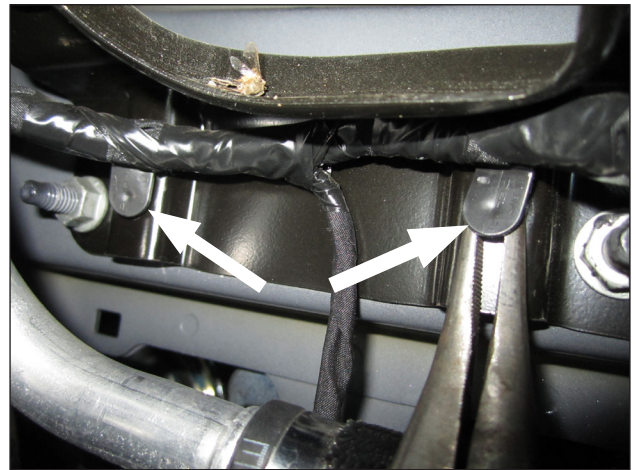

z. Unclip the wiring harness from the intake mounting bracket.



aa. Remove the aluminum insulator shield and putty from the stud to access the right hex nut.



ab. Remove the two hex nuts holding the mounting bracket, then remove the bracket.

3. Installation of AEM® Intake System

a. When installing the intake system, do not completely tighten the hose clamps or mounting hardware until instructed to do so.



a. For the best fit, cut a 1/8" x 1/8" notch on the the small end of the silicone adapter (D).



b. Install the #32 hose clamp (I) and the adapter onto the turbo inlet, then loosely install a #44 clamp (H) onto the large end of the adapter.

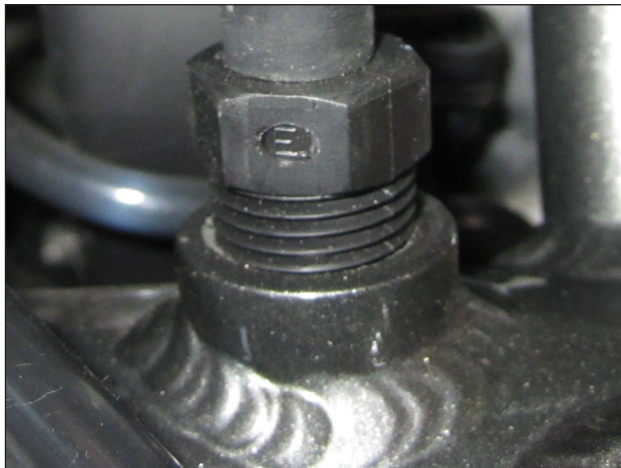

c. Install the plastic vent fitting (J) into the new upper intake tube (A) until seated.

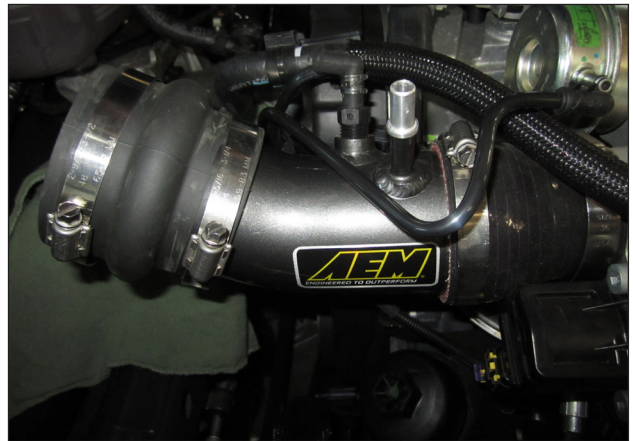

d. Install the upper intake tube (A), a #44 clamp (H), the rubber hump hose (E), and a #48 clamp (G) onto the adapter as shown. Do not tighten.



e. Connect the secondary vacuum line elbow to the new vent fitting in the intake tube.

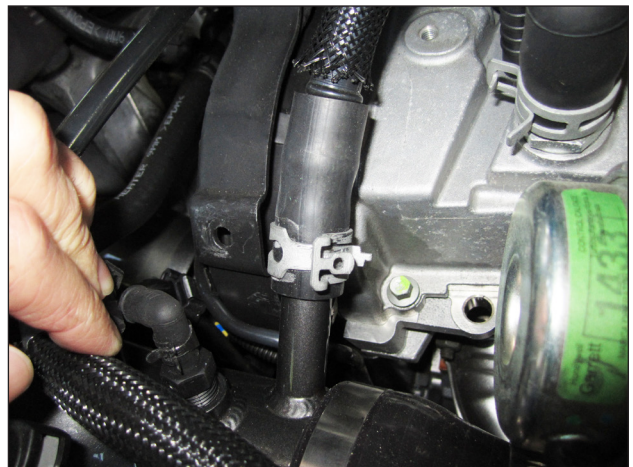

f. Connect the breather tube and secure it with the stock clamp.

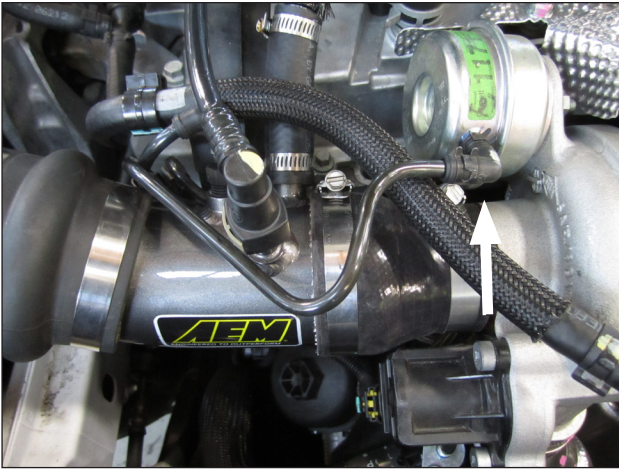

g. Re-connect the vacuum line elbow to the turbo wastegate actuator. Route the line as shown.

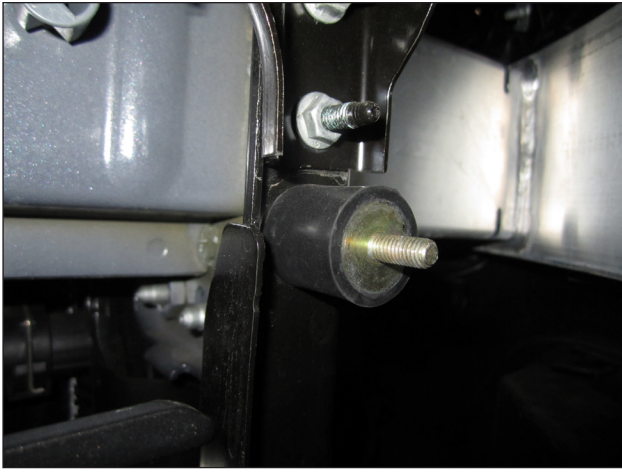

i. Underneath the right headlight, install the rubber isolator (K) mount into the top hole in the right radiator core support bracket, and secure from behind with a flat washer (L) and M6 hex nut (M).

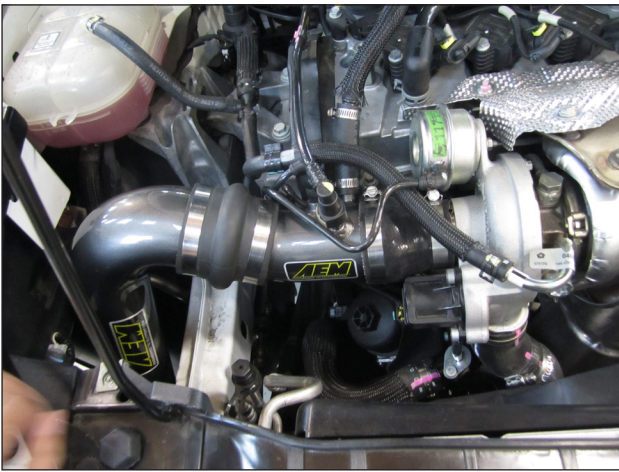

j. Install the lower intake tube (B) into the hump hose as shown. Do not tighten the hose clamp.

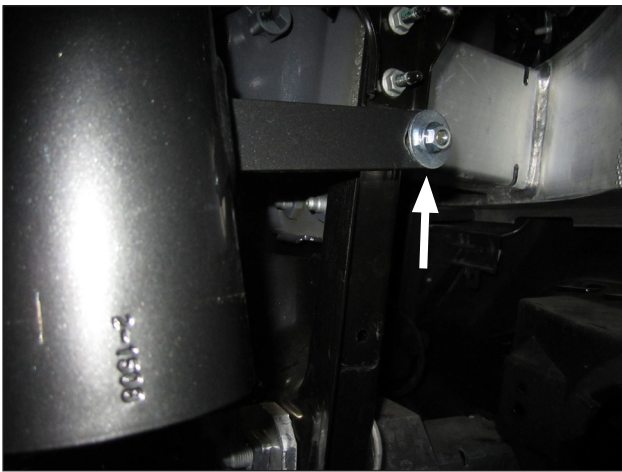

j. Under the bumper, secure the lower intake tube bracket to the rubber mount with flat washer (L) and M6 hex nut (M).

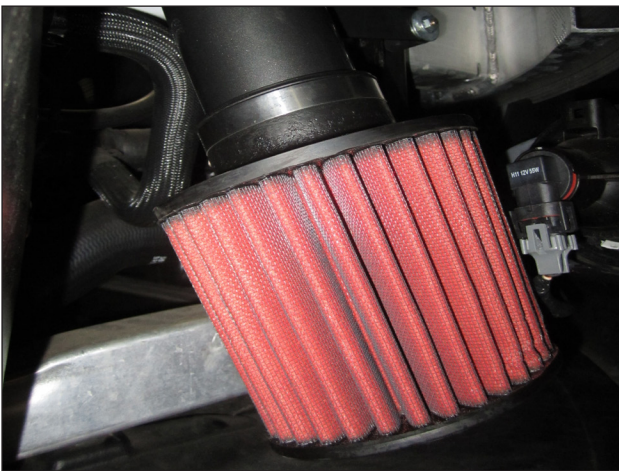

k. Install the #52 (F) hose clamp and the AEM Dryflow air filter (C) onto the lower intake tube. Fully tighten the hose clamp.



l. Now fully tighten the hose clamp securing the lower intake tube to the hump hose.

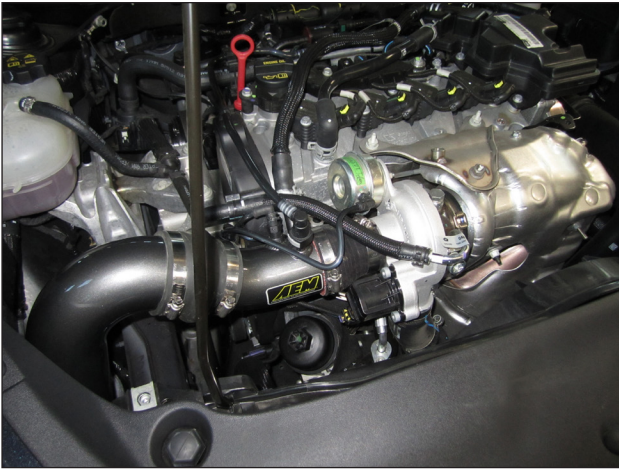

m. AEM-21-722 CAI Installed.



n. Reinstall the engine cover if so equipped.

4. Reassemble Vehicle

a. **Fender liner and splashguard:** Install the fender liners, lower splash guard, front bumper and any hardware that was removed in Steps 1i through 1u. Be sure to re-connect the radiator grill shutter wiring harness and the foglamp harnesses (if so equipped) before re-installing the splashguard.

NOTES: Failure to install the fender liner will increase the potential for engine damage due to water ingestion in wet conditions.

- b. Position the inlet pipes for the best fitment. Be sure that the pipes or any other components do not contact any part of the vehicle. Tighten any rubber mounts (if applicable), all bolts, and hose clamps.
- c. Check for proper hood clearance. Re-adjust pipes if necessary and re-tighten them.
- d. Inspect the engine bay for any loose tools and check that all fasteners that were moved or removed are properly tightened.
- e. Reconnect the negative battery terminal and start the engine. Let the vehicle idle for 3 minutes. Perform a final inspection before driving the vehicle.

5. CARB Sticker Placement

a. The C.A.R.B. exemption sticker, if applicable, must be visible under the hood so that an emissions inspector can it when the vehicle is required to be tested for emissions. California requires testing every two years, other states may vary.

6. Service and Maintenance

a. AEM Induction Systems requires cleaning the intake system's air filter element every 100,000 miles. When used in dusty or off-road environments, our filters will require cleaning more often. We recommend that you visually inspect your filter once every 25,000 miles to determine if the screen is still visible. When the screen is no longer visible some place on the filter element, it is time to clean it. To clean, purchase our Dryflow Synthetic Air Filter Cleaner, part number 1-1000 and follow the easy instructions.

b. Use window cleaner or a damp cloth to clean your powder coated AEM® intake tube.

NOTE: DO NOT USE aluminum polish on powder coated AEM® intake tubes.

For technical inquiries e-mail us at sales@aemintakes.com or call us at 800.992.3000

AEM Air Intake System Warranty Policy

AEM® warrants that its intake systems will last for the life of your vehicle. AEM will not honor this warranty due to mechanical damage (i.e. improper installation or fitment), damage from misuse, accidents or flying debris. AEM will not warrant its powder coating if the finish has been cleaned with a hydrocarbon-based solvent. The powder coating should only be cleaned with a mild soap and water solution. Proof of purchase of both the vehicle and AEM intake system is required for redemption of a warranty claim.

This warranty is limited to the repair or replacement of the AEM part. In no event shall this warranty exceed the original purchase price of the AEM part nor shall AEM be responsible for special, incidental or consequential damages or cost incurred due to the failure of this product. Warranty claims to AEM must be transportation prepaid and accompanied with dated proof of purchase. This warranty applies only to the original purchaser of product and is nontransferable. Improper use or installation, use for racing, accident, abuse, unauthorized repairs or alterations voids this warranty. AEM disclaims any liability for consequential damages due to breach of any written or implied warranty on all products manufactured by AEM. Warranty returns will only be accepted by AEM when accompanied by a valid Return Merchandise Authorization (RMA) number. Credit for defective products will be issued pending inspection. Product must be received by AEM within 30 days of the date RMA is issued.

If you have a warranty issue, please call (800) 992-3000 and our customer service department will assist you. A proof of purchase is required for all AEM warranty claims.