



Equipped with AEM® Dryflow™ Filter
No Oil Required!

INSTALLATION INSTRUCTIONS

PART NUMBER:

21-691C

(Gun Metal Grey Finish)

21-691P

(Vacuum Metalized Chrome - VMC)

2010-2011 KIA Soul L4-2.0L C.A.R.B. E.O. # D-670-21

PARTS LIST

Description	Qty.	Part Number
A 1/2" Bnd. Hose Clamp, 2.31-3.25"	1	9444
B Hose; 3" To 2-3/4" ID 90 Deg. Angled Reinforced	1	084012
C 1/2" Bnd. Hose Clamp, 2.90"-3.75"	2	9452
D Inlet Pipe	1	2-1408C/P
E Hose; 3/8"ID X 3.5"L	1	5-1305
F Hose Clamp, 3/4"	2	4093-5
G Heat Shield	1	20-8504
H Mount, Rubber 1" X 6mm	1	1228599
I Washer, 6mm Soft Mount	4	08160
J Nut, M6 Hex Serrated	3	444.460.04
K Edge Trim, 6"	1	8-4006
L Edge Trim, 14"	1	8-4014
M Bolt, Hex M6 X 1.0 X 16mm	2	1-2030
N Air Filter Assy. Offset 3"x5" Dry	1	21-203DOSK

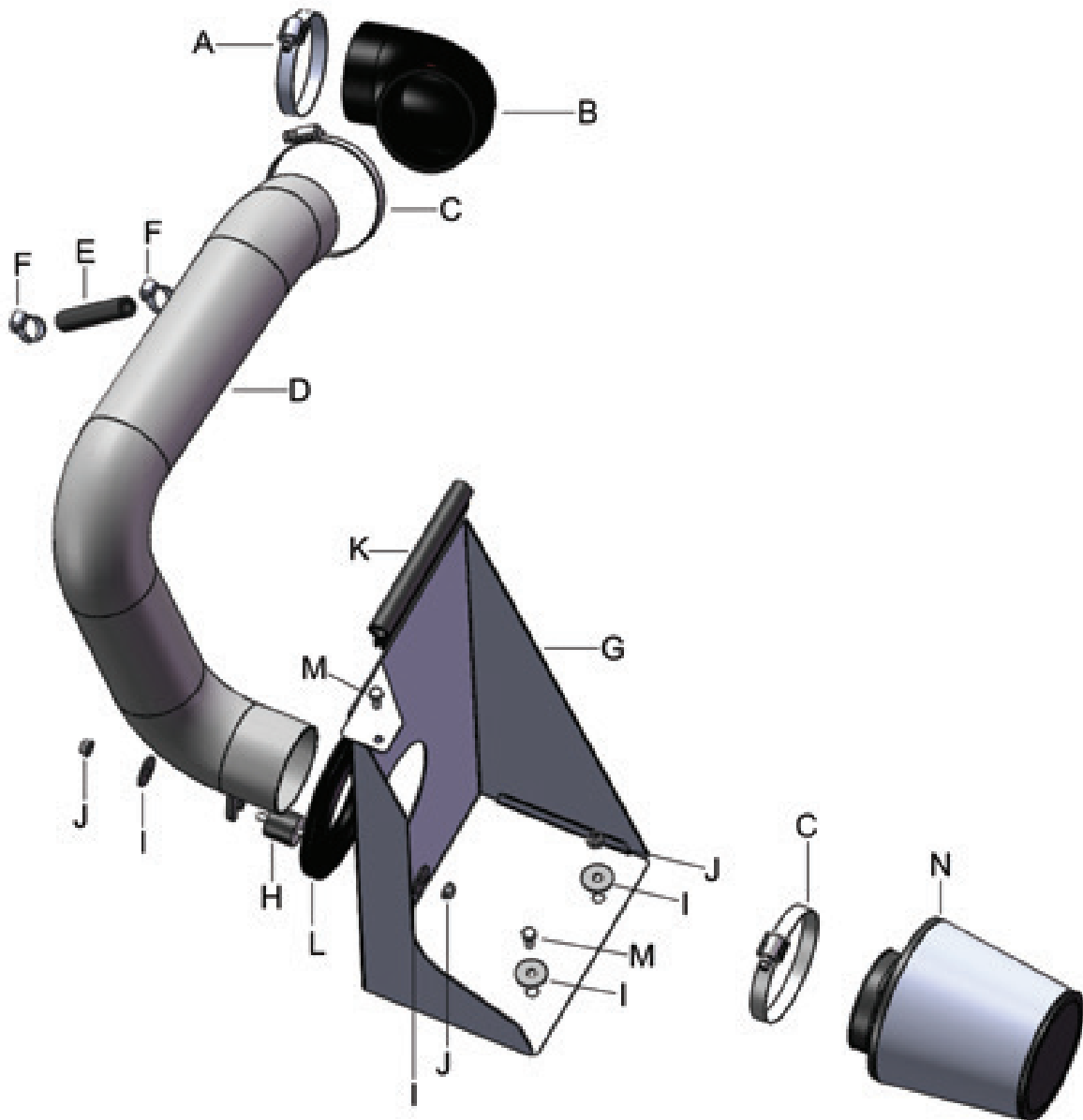

Read and understand these instructions **BEFORE** attempting to install this product. Failure to follow installation instructions and not using the provided hardware may damage the intake tube, throttle body and engine.

1. Preparing Vehicle

- a. Make sure vehicle is parked on level surface.
- b. Set parking brake.
- c. If engine has run in the past two hours, let it cool down.
- d. Disconnect negative battery terminal.
- e. Do not discard stock components after removal of the factory system.

2. Removal of stock system



a. Open the vehicle hood and locate the factory air filter housing and flexible intake tube assembly.



b. Release the 2 clips to open the air filter housing and lift the upper lid.



c. Un-clip the small throttle bypass valve wiring harness clip from the small valve cover intake breather hose. Do not disconnect the wiring harness itself.



d. Un-clamp and disconnect the small valve cover intake breather hose at the valve cover.

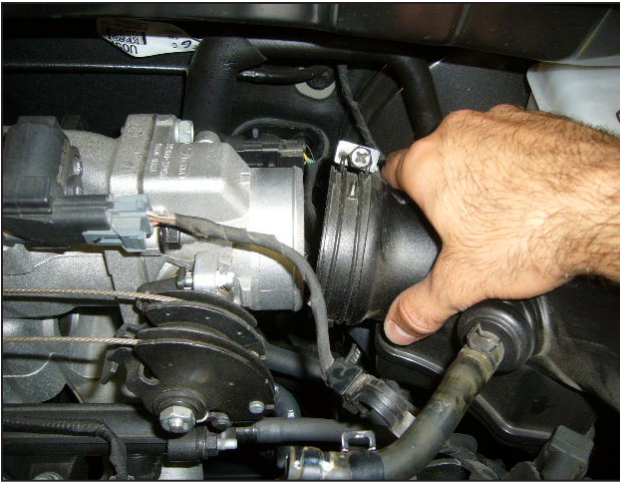

e. Loosen the large hose clamp and disconnect the air intake tube at the throttle body.



f. Remove the factory air filter housing lid and air intake tube from the engine compartment.

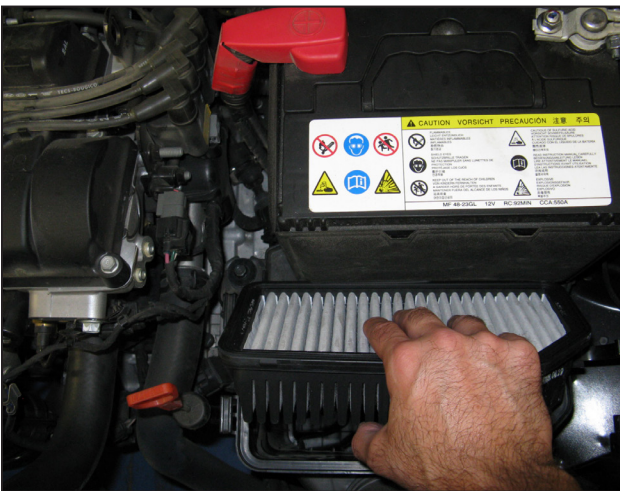

g. Remove the original air filter from the lower housing.

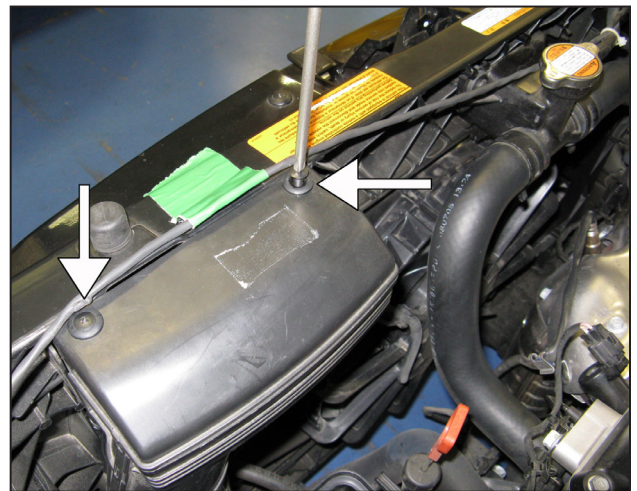

h. Remove 2 Phillips screws mounting the bypass pipe to the radiator top support frame rail.

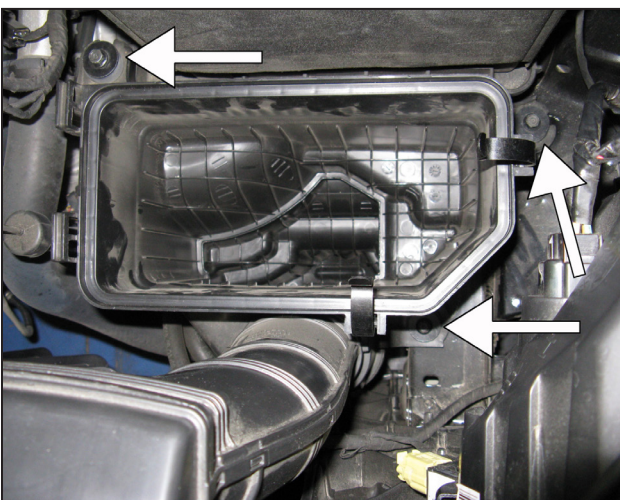

i. Remove the 3 lower air filter housing mounting bolts.

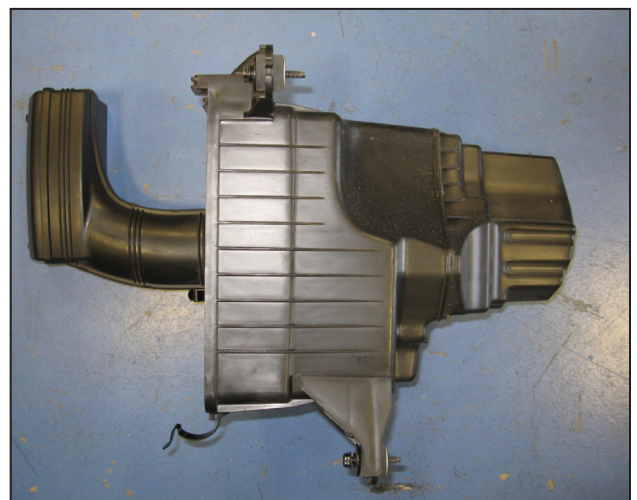

j. Remove the lower air filter housing and bypass pipe assembly from the engine compartment.

3. Installation of AEM® intake system.

a. When installing the intake system, do not completely tighten the hose clamps or mounting hardware until instructed to do so.

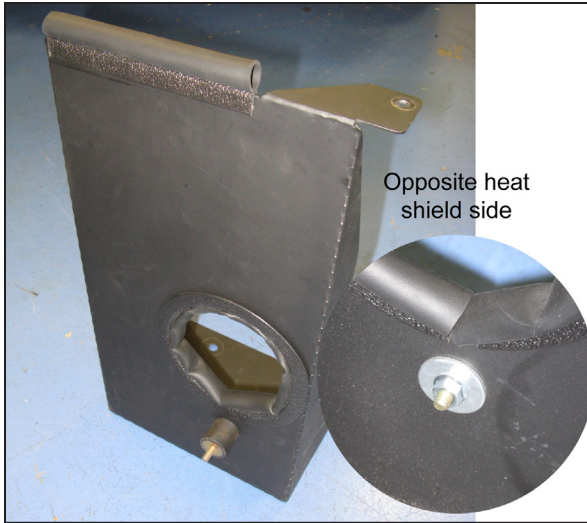

b. Install the 2 insulated edge molding gaskets and the rubber isolated bolt onto the heat shield as shown.

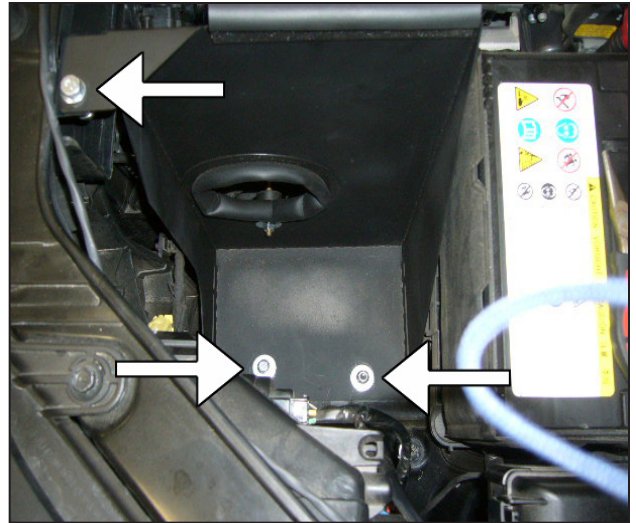

c. Install the heat shield and mount securely using the 2 washers, 2 bolts, and 1 hex nut.



d. Install the intake tube by passing it through the large insulated hole in the heat shield, rotating it to connect the rubber coupling elbow onto the throttle body. Secure the hose clamp but do not completely tighten.

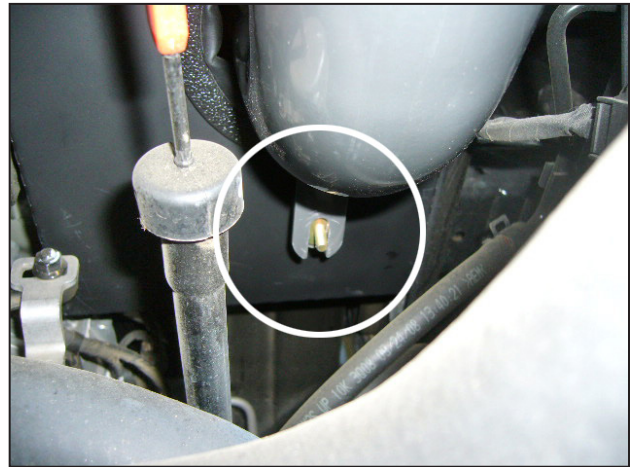

e. Mount the intake tube bracket to the heat shield at the rubber isolated bolt using 1 washer and 1 nut. Tighten the nut, and then fully tighten the large hose clamp at the throttle body coupler.

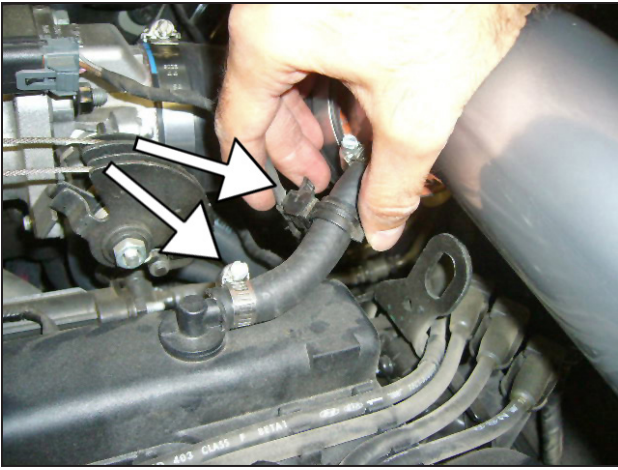

f. Connect the small valve cover intake breather hose from the air intake tube onto the valve cover nipple and secure it with the small hose clamp included in the kit. Tighten the small hose clamp. Clip the small throttle bypass wiring harness clip onto the new valve cover breather hose.

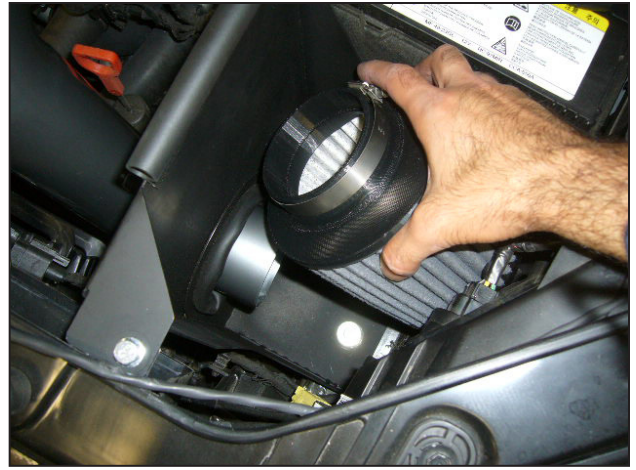

g. Mount the AEM® air filter and hose clamp onto the open end of the intake tube, inside the heat shield. Be sure to push the filter down onto the pipe until it reaches the internal stop.

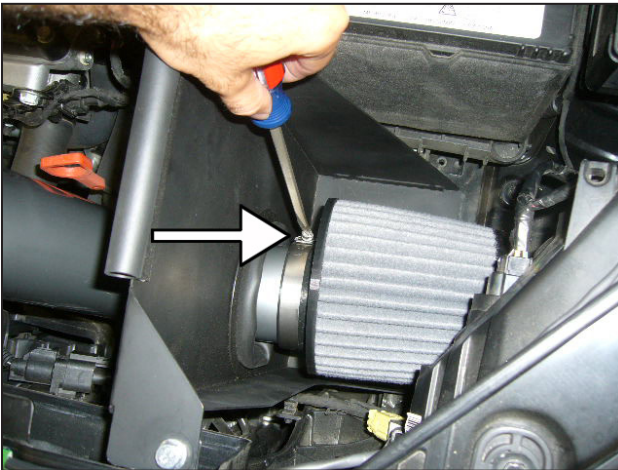

h. Note the orientation of the air filter. Rotate the filter at the flange so that the filter body is positioned away from the headlight wiring harness. Once proper fitment is achieved, secure the air filter's hose clamp.



Factory airbox system installed



AEM® intake system installed

4. Reassemble Vehicle

- a. Position the inlet pipes for the best fitment. Be sure that the pipes or any other components do not contact any part of the vehicle. Tighten the rubber mount, all bolts, and hose clamps.
- b. Check for proper hood clearance. Re-adjust pipes if necessary and re-tighten them.
- c. Inspect the engine bay for any loose tools and check that all fasteners that were moved or removed are properly tightened.
- d. Reconnect negative battery terminal and start engine. Let the vehicle idle for 3 minutes. Perform a final inspection before driving the vehicle.

5. CARB Sticker Placement

- a. The C.A.R.B. exemption sticker, (attached), must be visible under the hood so that an emissions inspector can see it when the vehicle is required to be tested for emissions. California requires testing every two years, other states may vary.

6. Service and Maintenance

- a. AEM Induction Systems requires cleaning the intake system's air filter element every 100,000 miles. When used in dusty or off-road environments, our filters will require cleaning more often. We recommend that you visually inspect your filter once every 25,000 miles to determine if the screen is still visible. When the screen is no longer visible some place on the filter element, it is time to clean it. To clean, purchase our Synthetic air filter cleaner, part number 99-0624 and follow the easy instructions.
- b. Use window cleaner to clean your powder coated AEM® intake tube.

NOTE: DO NOT USE aluminum polish on powder coated AEM® intake tubes.

For technical inquiries
e-mail us at
sales@aemintakes.com
or
call us at
800.992.3000

AEM Air Intake System Warranty Policy

AEM® warrants that its intake systems will last for the life of your vehicle. AEM will not honor this warranty due to mechanical damage (i.e. improper installation or fitment), damage from misuse, accidents or flying debris. AEM will not warrant its powder coating if the finish has been cleaned with a hydrocarbon-based solvent. The powder coating should only be cleaned with a mild soap and water solution. Proof of purchase of both the vehicle and AEM intake system is required for redemption of a warranty claim.

This warranty is limited to the repair or replacement of the AEM part. In no event shall this warranty exceed the original purchase price of the AEM part nor shall AEM be responsible for special, incidental or consequential damages or cost incurred due to the failure of this product. Warranty claims to AEM must be transportation prepaid and accompanied with dated proof of purchase. This warranty applies only to the original purchaser of product and is nontransferable. Improper use or installation, use for racing, accident, abuse, unauthorized repairs or alterations voids this warranty. AEM disclaims any liability for consequential damages due to breach of any written or implied warranty on all products manufactured by AEM. Warranty returns will only be accepted by AEM when accompanied by a valid Return Merchandise Authorization (RMA) number. Credit for defective products will be issued pending inspection. Product must be received by AEM within 30 days of the date RMA is issued.

If you have a warranty issue, please call (800) 992-3000 and our customer service department will assist you. A proof of purchase is required for all AEM warranty claims.