



Equipped with AEM® Dryflow™ Filter  
No Oil Required!

## **INSTALLATION INSTRUCTIONS**

**PART NUMBER:**

**21-509B (Blue Finish)**

**21-509C (Gun Metal Grey Finish)**

**21-509P (Vacuum Metalized Chrome-VMC)**

**21-509R (Red Finish)**

---

2003 ACURA CL Type-S V6-3.2L Manual Transmission C.A.R.B. E.O. # D-670-15

**Intake systems for vehicles listed are 50  
state legal. See [AEMIntakes.com](http://AEMIntakes.com) for CARB  
status on each part for a specific vehicle.**

## PARTS LIST

Description	Qty.	Part Number
Element Parts Kit 3.00 X 5" Dry Ele.	1	21-203DK
Inlet Pipe	1	2-523
Hose, Silicone 3.00x2" Black	1	5-302
Hose; 5/8"ID X 18"L	1	5-7018
Mount, Rubber 1" X 6mm	1	1228599
Washer, 6mm Soft Mount	1	08160
Nut, M6 Hex Serrated	1	444.460.04
1/2" Bnd. Hose Clamp, 2.56"-3.50"	2	9448
Hose Clamp, 1"	2	08407
1/2" Bnd. Hose Clamp, 2.90"-3.75"	1	9452

Read and understand these instructions **BEFORE** attempting to install this product. Failure to follow installation instructions and not using the provided hardware may damage the intake tube, throttle body and engine.

The AEM<sup>®</sup> intake system is a performance product that can be used safely during mild weather conditions. During harsh and inclement weather conditions, you must return your vehicle to stock OEM air box and intake tract configuration. Failure to follow these instructions will void your warranty.

## 1. Preparing Vehicle

- a. Make sure vehicle is parked on level surface.
- b. Set parking brake.
- c. If engine has run in the past two hours, let it cool down.
- d. Disconnect negative battery terminal.
- e. Do not discard stock components after removal of the factory system.

## 2. Removal of stock system

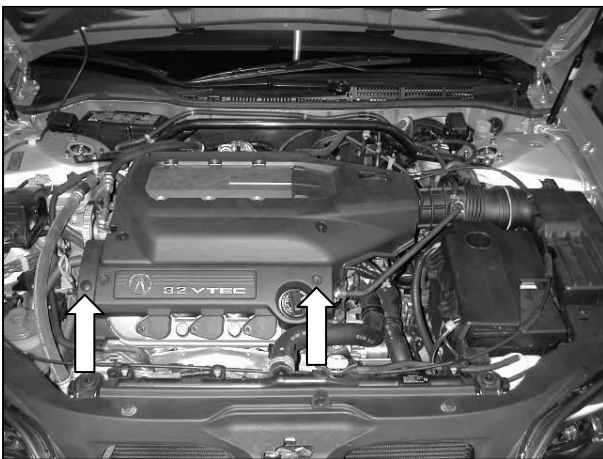

a. Loosen tabs and remove cover.

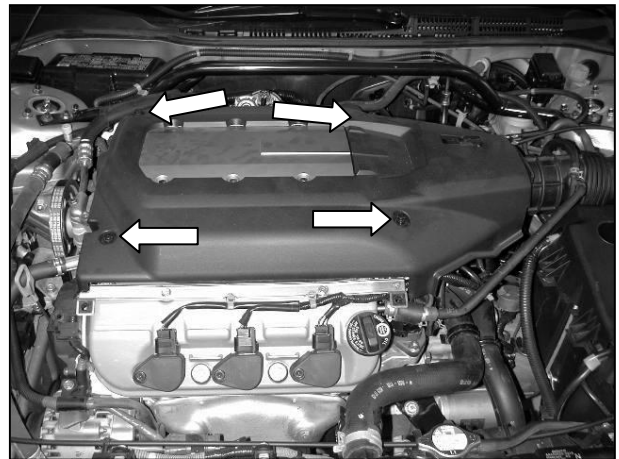

b. Remove 4 bolts to plastic valve cover assembly and remove valve cover.

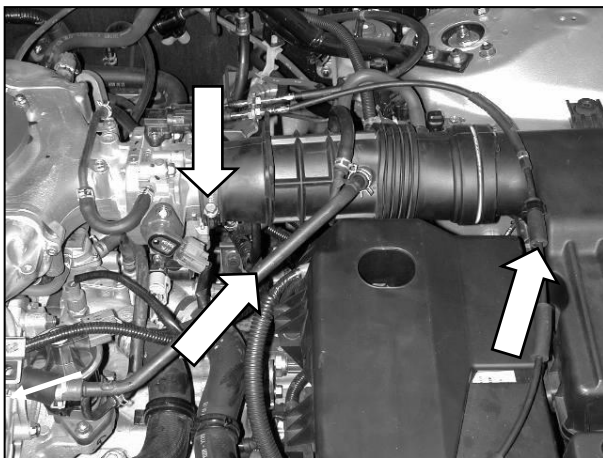

c. Unclip cruise control cable, remove breather hose, loosen hose clamp.

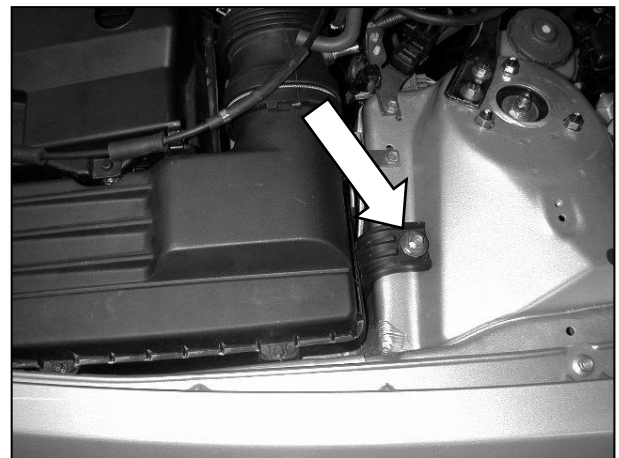

d. Loosen bolt.

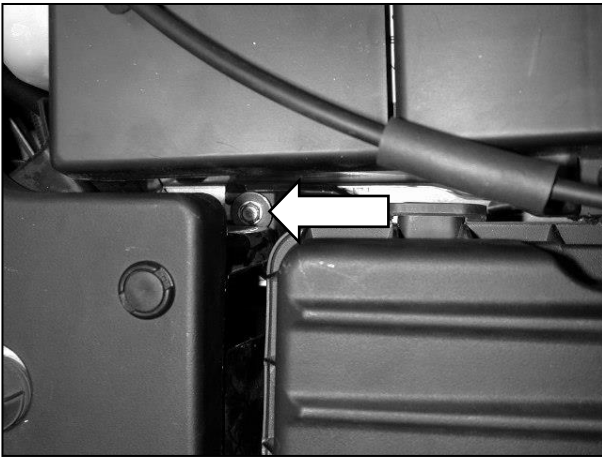

e. Loosen bolt.

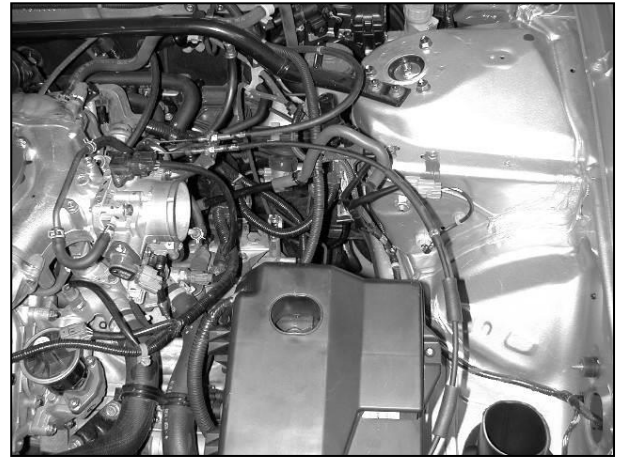

f. Remove air box assembly.

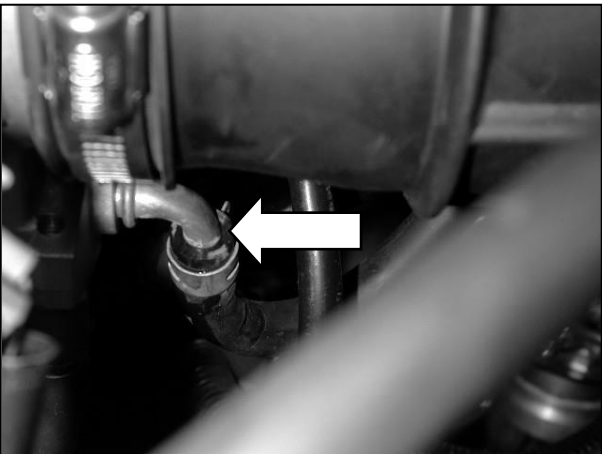

g. **CAUTION: Ensure the engine is completely cool before removing the coolant hose, or hot coolant will escape from the cooling system and cause injury or damage. Be sure to capture any lost coolant in a clean container.**

Loosen radiator cap. Disconnect coolant line under throttle body. This line will be removed with stock system.

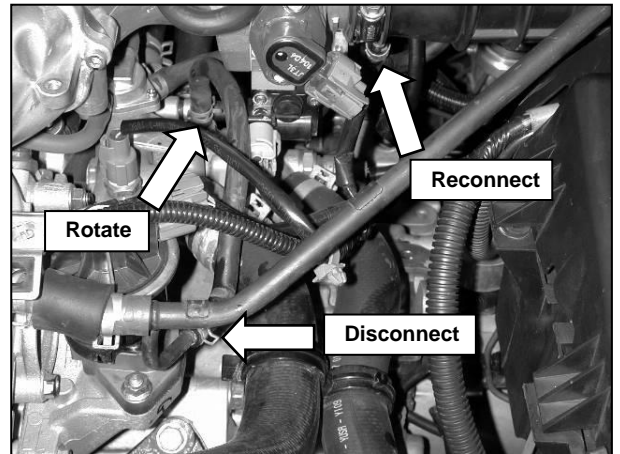

h. Disconnect coolant line. Rotate the base of the line 90 degrees counter clockwise. Reconnect the coolant line under the throttle body where the nipple has been exposed in step g.

**NOTE: Replace any coolant recovered during hose removal by replenishing the recovery tank.**

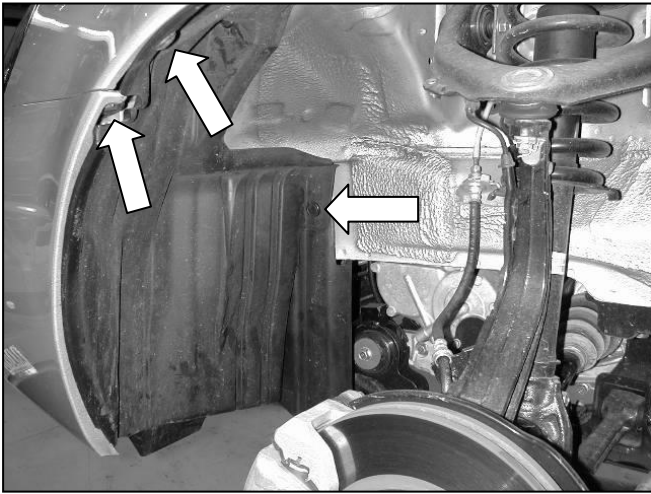

i. Raise the front of the vehicle with a jack. Refer to your owner's manual for proper jack and jack stand placement to properly support vehicle. Support your vehicle using properly rated jack stands before wheel removal or while working under the vehicle. **NEVER WORK UNDER A VEHICLE WITHOUT USING JACK STANDS.** Remove front driver wheel. Remove plastic clips as shown.

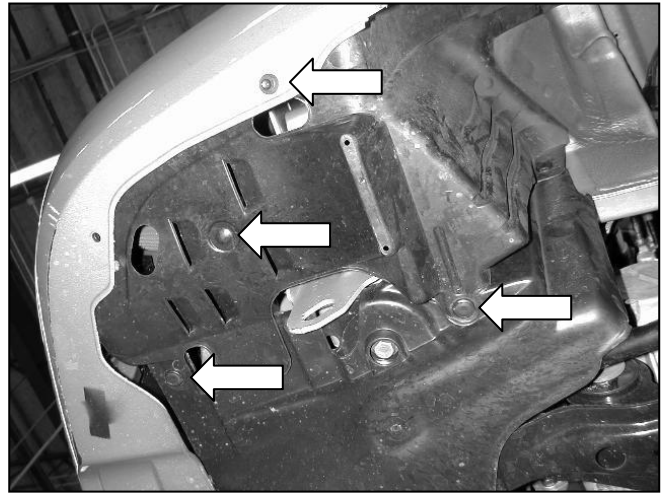

j. Remove bolt and remaining clips. Fold plastic shielding back and out of the way to access the resonator assembly.

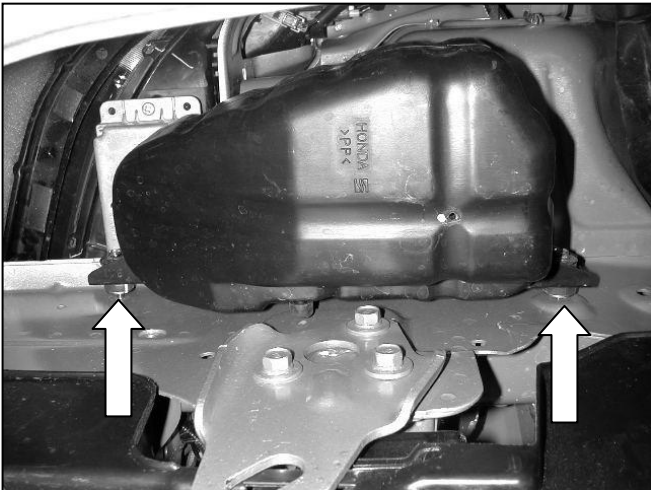

k. Loosen bolts and remove resonator assembly.

### 3. Installation of AEM® intake system.

- a. When installing the intake system, do not completely tighten the hose clamps or mounting hardware until instructed to do so.

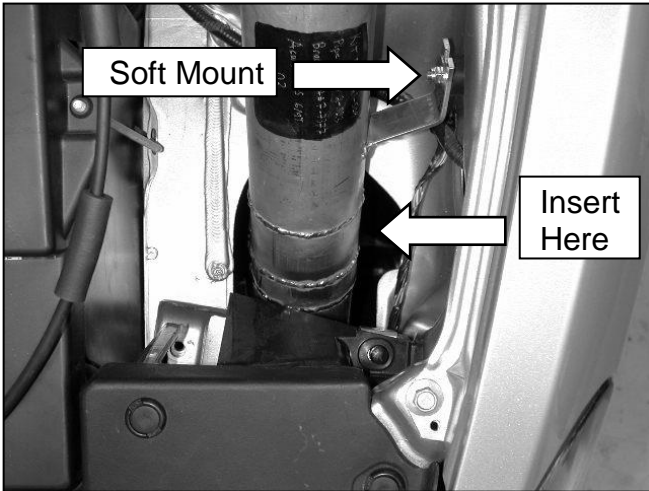

b. Insert the intake pipe through opening left by resonator assembly. Attach the soft mount to fender wall. See diagram below for proper installation of rubber mount assembly.

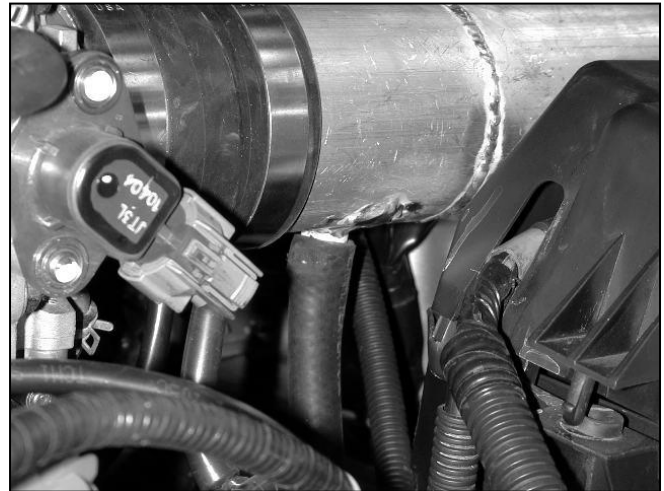

c. Attach 3" coupler and hose clamps to throttle body. Attach the intake pipe to the coupler.

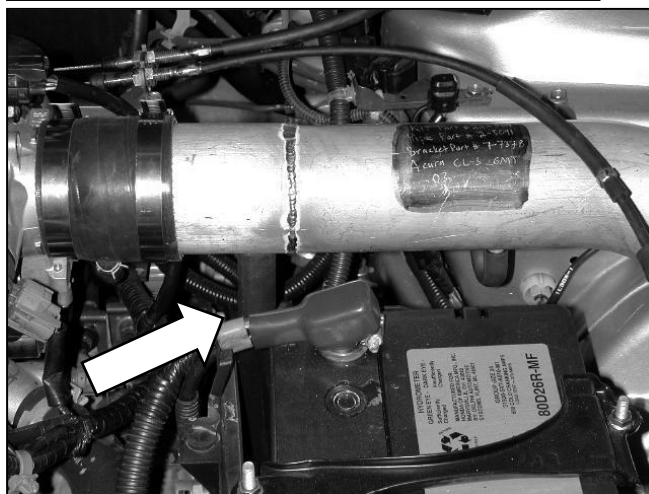
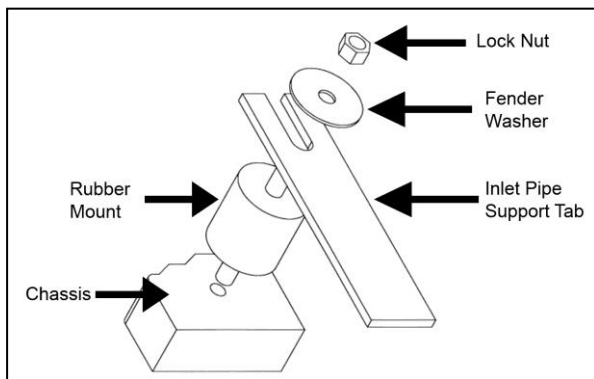

d. Attach the factory breather tube. Attach the supplied 5/8" breather hose to the inlet pipe and valve cover. Secure using the two supplied hose clamps.



e. Attach washer and serrated nut.

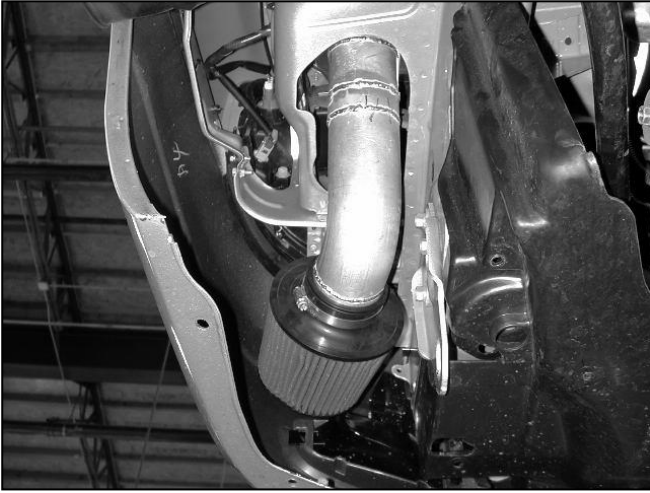

f. Attach the air filter assembly.

#### 4. Reassemble Vehicle

- a. **Fender liner:** Install the fender liner and any hardware that was removed in steps 2i. and 2j.  
**NOTE: Failure to install the fender liner will result in diminished performance and increase the potential for engine damage due to water ingestion in rainy conditions.**
- b. **Wheel:** Install the driver's side wheel using the factory torque specification (see owner's manual).
- c. Position the inlet pipes for the best fitment. Be sure that the pipes or any other components do not contact any part of the vehicle. Tighten the rubber mount, all bolts, and hose clamps.
- d. Check for proper hood clearance. Re-adjust pipes if necessary and re-tighten them.
- e. Inspect the engine bay for any loose tools and check that all fasteners that were moved or removed are properly tightened.
- f. Reconnect negative battery terminals and start engine. Let the vehicle idle for 3 minutes. Perform a final inspection before driving the vehicle.
- g. Reset the radio and navigation code, may take up to 10 minutes for GPS to reset.

#### 5. CARB Sticker Placement

- a. The C.A.R.B. exemption sticker, (attached), must be visible under the hood so that an emissions inspector can see it when the vehicle is required to be tested for emissions. California requires testing every two years, other states may vary.

#### 6. Service and Maintenance

- a. It is recommended that you service your AEM<sup>®</sup> Dryflow<sup>™</sup> filter every 20,000 miles for optimum performance. Use AEM Dryflow cleaning kit part # 21-110.
- b. Use aluminum polish to clean your polished AEM<sup>®</sup> intake tube.
- c. Use window cleaner to clean your powder coated AEM<sup>®</sup> intake tube. **(NOTE: DO NOT USE aluminum polish on powder coated AEM intake tubes).**

For technical inquiries  
e-mail us at  
sales@aemintakes.com  
or  
call us at  
800.992.3000

### **AEM Air Intake System Warranty Policy**

AEM® warrants that its intake systems will last for the life of your vehicle. AEM will not honor this warranty due to mechanical damage (i.e. improper installation or fitment), damage from misuse, accidents or flying debris. AEM will not warrant its powder coating if the finish has been cleaned with a hydrocarbon-based solvent. The powder coating should only be cleaned with a mild soap and water solution. Proof of purchase of both the vehicle and AEM intake system is required for redemption of a warranty claim.

This warranty is limited to the repair or replacement of the AEM part. In no event shall this warranty exceed the original purchase price of the AEM part nor shall AEM be responsible for special, incidental or consequential damages or cost incurred due to the failure of this product. Warranty claims to AEM must be transportation prepaid and accompanied with dated proof of purchase. This warranty applies only to the original purchaser of product and is nontransferable. Improper use or installation, use for racing, accident, abuse, unauthorized repairs or alterations voids this warranty. AEM disclaims any liability for consequential damages due to breach of any written or implied warranty on all products manufactured by AEM. Warranty returns will only be accepted by AEM when accompanied by a valid Return Merchandise Authorization (RMA) number. Credit for defective products will be issued pending inspection. Product must be received by AEM within 30 days of the date RMA is issued.

If you have a warranty issue, please call (800) 992-3000 and our customer service department will assist you. A proof of purchase is required for all AEM warranty claims.

**Intake systems for vehicles listed are 50  
state legal. See AEMIntakes.com for CARB  
status on each part for a specific vehicle.**