

Installation Guide for Toyota GR Supra PN 140826CFBA



******* Please compare the parts in the box with the bill of materials provided *****
to assure that you have all the parts necessary for this installation.**

These instructions have been written to help you with the installation of your Borla Performance exhaust system. Please read this document completely before beginning the installation of your system.

To ensure this part number fits your specific model year, please visit our website for the latest model year listings at www.BORLA.com

Thank you for purchasing a Borla Performance Cat-Back™ exhaust system.

This Borla Performance Cat-Back™ exhaust system (PN 140826CFBA) is designed for the Toyota GR Supra, equipped with a 3.0L turbocharged I6 engine and automatic transmission.

Borla Performance Industries recommends that an exhaust shop or professional after market parts installer, who has all the necessary equipment, tools and experienced personnel needed for proper installation, should perform the installation of this system. However, if you decide to perform the installation, we recommend someone should help you. Ensure the installer uses all under car safety precautions including eye protection.

Please take time to read and understand the following...

By installing your Borla Performance exhaust system, you indicate that you have read this document and you agree with the terms stated below.

It is the responsibility of the purchaser to follow all installation instruction guidelines and safety procedures supplied with your Borla Performance Exhaust System.

Borla Performance Industries assumes no responsibility for damages occurring from misuse, abuse, improper installation, improper operation, lack of responsible care, or all previously stated reasons resulting from incompatibility with other manufacturer's products and/or systems.

Included with your Borla Performance exhaust system is a warranty card. Please read it carefully before you begin any work on your vehicle. If you should have any questions regarding our warranty policy, installation, or any other matter pertaining to your new Borla Performance exhaust system, please give us a call at the number provided on the warranty card.

Minimum Required Tool List:

TOOLS:

1. 3/8" drive ratchet
2. 3/8" drive extension 6"
3. 15mm socket
4. 13mm socket
5. 10mm socket
6. 8mm socket
7. Pry bar

SHOP SUPPLIES:

1. Spray lubricant

Borla Performance Bill of Materials

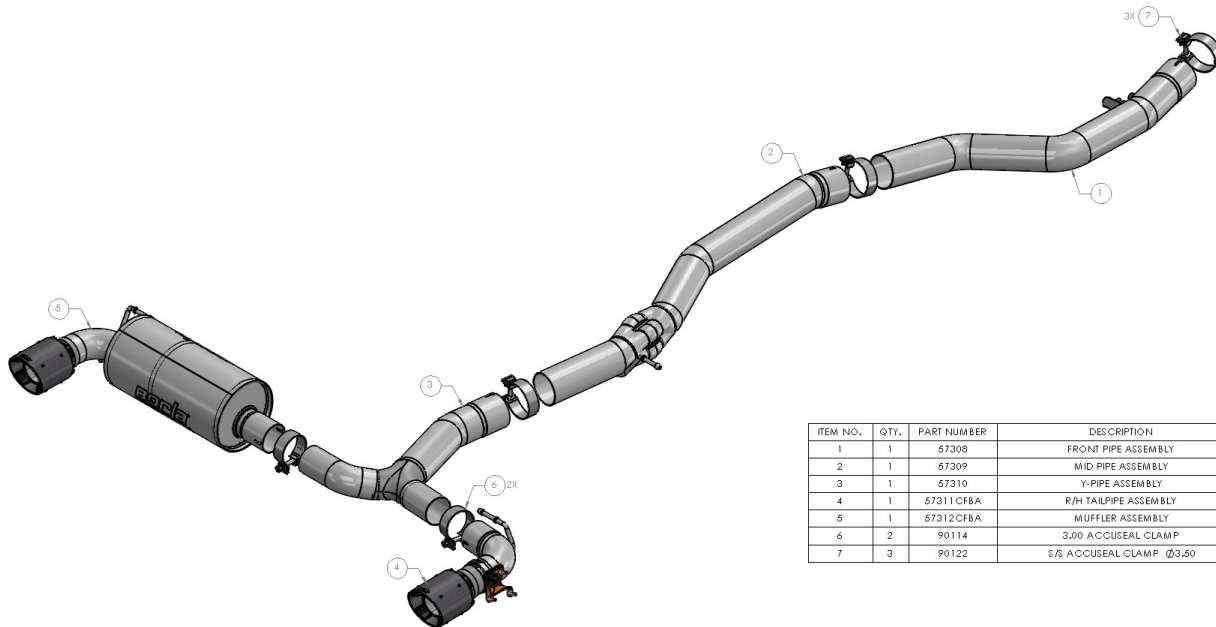

ITEM NO.	QTY.	PART NUMBER	DESCRIPTION
1	1	57308	FRONT PIPE ASSEMBLY
2	1	57309	MID PIPE ASSEMBLY
3	1	57310	Y-PIPE ASSEMBLY
4	1	57311 CF8A	R/H TAILPIPE ASSEMBLY
5	1	57312 CF8A	MUFFLER ASSEMBLY
6	2	90114	3.00 ACCUSEAL CLAMP
7	3	90122	S/S ACCUSEAL CLAMP Ø3.50

Caution!!! *Never work on a hot exhaust system. Serious injury in the form of burns can result if the vehicle has been in use and the exhaust system is hot, allow vehicle to cool for at least 1 hour. Always wear eye protection when working under any vehicle.*

Note: *It is our recommendation that you use a hoist or hydraulic lift to facilitate the installation of your new Borla Performance Exhaust System.*

Taking all under car safety precautions, lift the vehicle using a hoist or hydraulic lift. Once this has been done, you may begin the removal of your old exhaust system from your vehicle.

Note: *Before removing the original exhaust system from your vehicle, please compare the parts you have received with the bill of materials provided on the previous page to assure that you have all the parts necessary for the installation of your new Borla Performance Exhaust System.*

Note: *With a used vehicle, we suggest a penetrating spray lubricant to be applied liberally to all exhaust fasteners and allowing a significant period of time for the chemical to lubricate the threads before attempting to disassemble.*

Original Exhaust System Removal

1. Lubricate all hangers, rubber isolators, bolts and nuts. **Note:** Keep all original hardware for reinstallation.
2. Remove the hanger bolt on the front pipe (fig. 1).
3. Loosen the clamp on the front pipe (fig. 2).
4. Remove the hardware on the underbody covers to gain access to the crossmember (figs. 3, 4).
5. Remove the hardware on the crossmember (fig. 5).

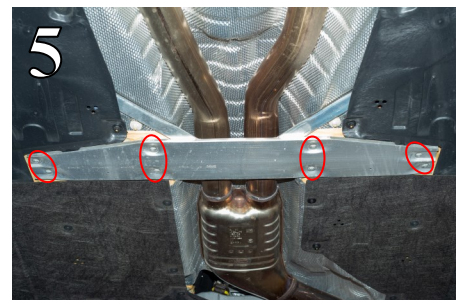
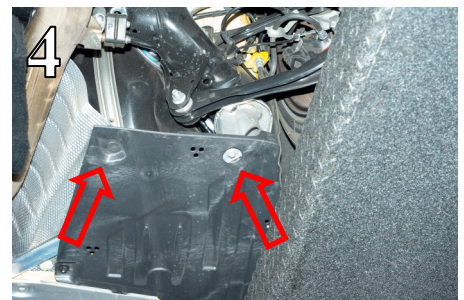

Original Exhaust System Removal Cont'd

6. Remove the L/H rear muffler hanger bracket from the chassis of the vehicle (fig. 6).
7. On the right side of the rear muffler, disconnect the wiring harness on the valve actuator (fig. 7).
8. Remove the R/H rear muffler hanger bracket from the chassis of the vehicle (fig. 8).
9. Remove the mid-pipe hanger from its rubber isolator (fig. 9).
10. Using a muffler stand or an additional person, remove the entire exhaust system as a single piece from the vehicle (fig. 10).

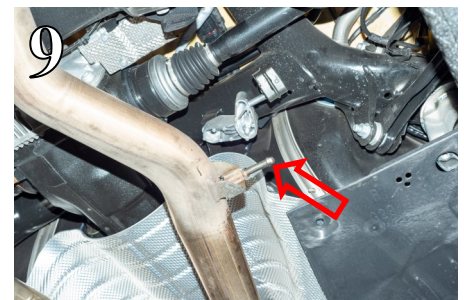
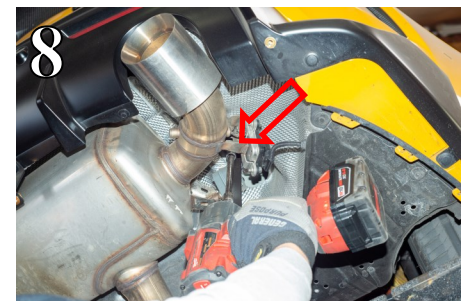
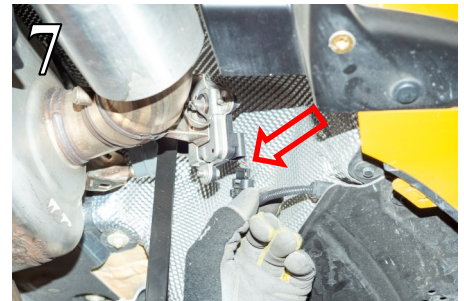
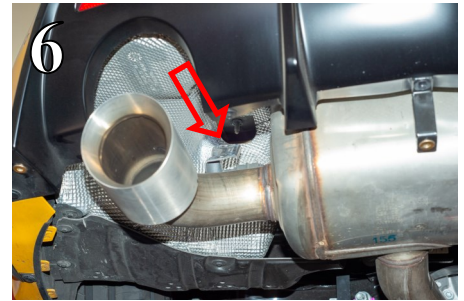

Borla Performance Cat-Back™ Exhaust System Installation

11. Orient the components on the shop floor according to Borla bill of materials drawing on page 2.
12. Connect the adapter to the front pipe and secure with a clamp (not pictured; see drawing).
13. Connect the assembled pieces from the previous step to the outlet of the downpipe (figs. 11, 12).
14. Slide a clamp over the inlet of the mid-pipe and connect it to the front pipe (fig. 13).
15. Insert the mid-pipe hanger into its rubber isolator (fig. 14).
16. Fasten the front pipe to the chassis using the original hardware (fig. 15). Loosen the clamps on the front pipe to adjust location if required.

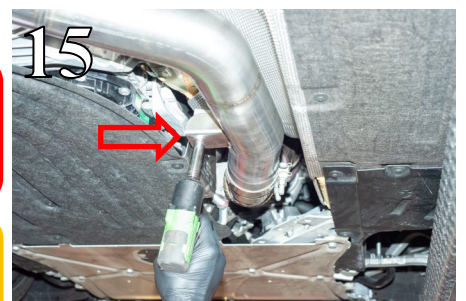
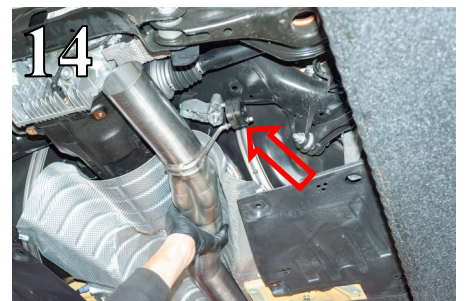

WARNING: Use extreme caution during installation. Torque all fasteners according to manufacturer's torque values and tightening sequence. **DO NOT** use air impact tools to tighten fasteners on Borla Performance Exhaust Systems. Use of such tools may result in bent flanges or gasket contact areas leading to exhaust leaks.

NOTE: When you first start your vehicle after the installation of your new Borla Performance Exhaust System, there may be some smoke and fumes coming from the system. This is a protective oil based coating used in the manufacturing of mandrel bent performance exhaust tubing. This is not a problem and will disappear within a very short period of time after the exhaust has reached normal operating temperatures.

Borla Performance Cat-Back™ Exhaust System Installation Cont'd

11. Slide a clamp over the inlet of the Y-pipe and connect it to the outlet of the mid-pipe (fig. 16).
12. Remove the L/H stock rear muffler hanger bracket and install them on the Borla muffler assembly (fig. 17).
13. Install the valve actuator onto the R/H tailpipe assembly (fig. 18). Ensure that the actuator drive is seated in the valve correctly.
14. Slide a clamp over the inlet of the muffler assembly and connect it to the L/H side of the Y-pipe (fig. 19).
15. Reinstall the L/H hanger bracket (fig. 20).

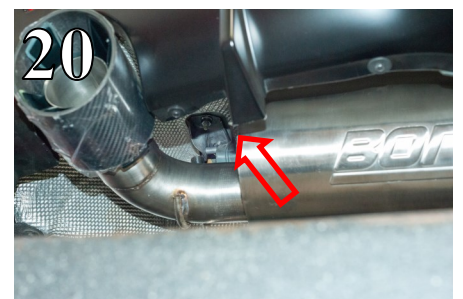
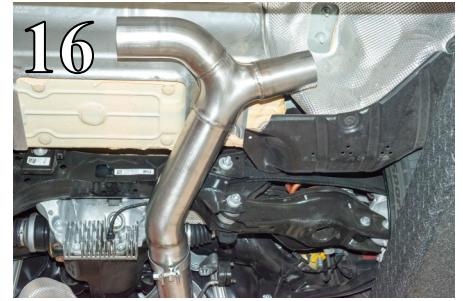

Borla Performance Cat-Back™ Exhaust System Installation Cont'd

25. Remove the R/H rear muffler hanger bracket assembly and install it onto the Borla R/H tailpipe assembly (fig. 21).
26. Slide a clamp over the inlet of the R/H tailpipe assembly and connect it to the Y-pipe (fig. 22).
27. Reinstall the crossmember (fig. 23).
28. Check your exhaust system for proper clearance under the vehicle and also for tip alignment (fig 24). Starting at the front flanges and moving to the rear of the vehicle, tighten flange hardware bolts. Orient position of bolt (on supplied clamps) between (not over) pipe notches and tighten to 35 ft. lbs. torque.
29. Align tips and tighten hardware. Loosen clamps to rotate or slide pipe for better alignment.
30. Before starting your vehicle, make sure to check all wires, hoses, brake lines, body parts and tires for safe clearance from the exhaust system.
31. Start the vehicle and check for any leaks. If any leaks are found, determine cause (such as loose or incorrectly positioned clamp) and repair as necessary.

