



INTAKE SYSTEMS FOR VEHICLES LISTED ARE 50 STATE LEGAL. SEE KNFILTERS.COM FOR CARB STATUS ON EACH PART FOR A SPECIFIC VEHICLE.

INSTALLATION INSTRUCTIONS

77-1538KP DODGE 2004-09 Durango V8-4.7L

NOTE: This kit was not designed to fit vehicles with a body lift.

TOOLS NEEDED:

- 4mm Allen Wrench
- Flat Blade Screwdriver
- 10mm Socket
- 13mm Socket
- 15mm Socket
- 17mm Socket
- 9/16" Socket
- 10mm Wrench
- 13mm Wrench
- Extension
- Ratchet

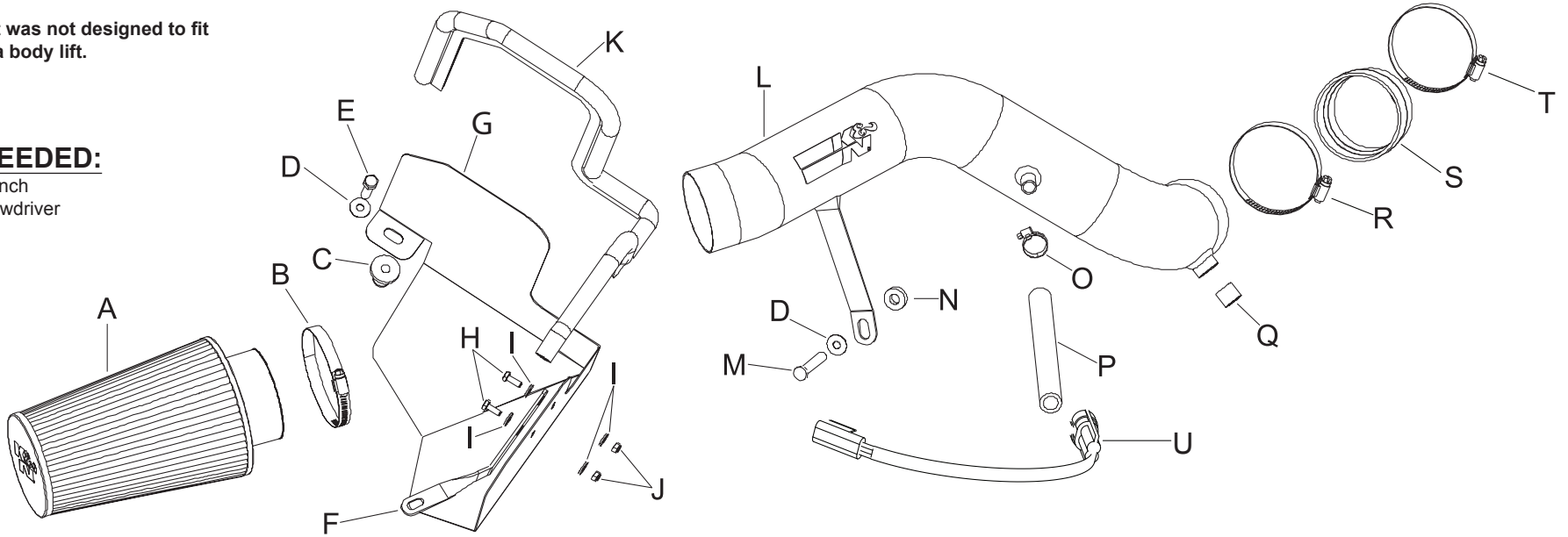

PARTS LIST:

Description	Qty.	Part #	Description	Qty.	Part #	Description	Qty.	Part #
A Air Filter	1	RC-3690	H Bolt, M6-1.00 x 16mm L, Hex	2	07812	O Hose Clamp, #8 Mini	1	08410
B Hose Clamp, #60	1	08624	I Washer, 6mm Flat	4	08269	P Silicone Hose, 1/2"ID X 17"L	1	08177
C Nut, 3/8"-16 Expansion	1	08163	J Nut, 6mm Nylock	2	07512	Q Silicone Hose, 17/32 x 11/16"L	1	084054
D Washer, 3/8" Flat, SS	2	08134	K Edge Trim, 3/4" Bulb, 35"L	1	102471	R Hose Clamp #56	1	08620
E Bolt, 3/8"-16 x 1-1/4"L, Hex	1	07779	L Intake Tube	1	27420	S Silicone Step Hose	1	084091
F Bracket, Twist	1	07197	M Bolt, M10-1.50 x 60mm L, Hex	1	07750	T Hose Clamp, #52	1	08610
G Heat Shield, Black	1	074023	N Spacer, 7/16"	1	21715	U Extension Harness	1	21680

NOTE: FAILURE TO FOLLOW INSTALLATION INSTRUCTIONS AND NOT USING THE PROVIDED HARDWARE MAY DAMAGE THE INTAKE TUBE, THROTTLE BODY AND ENGINE.

TO START:

1. Turn off the ignition and disconnect the negative battery cable.

NOTE: Disconnecting the negative battery cable erases pre-programmed electronic memories. Write down all memory settings before disconnecting the negative battery cable. Some radios will require an anti-theft code to be entered after the battery is reconnected. The anti-theft code is typically supplied with your owner's manual. In the event your vehicles' anti-theft code cannot be recovered, contact an authorized dealership to obtain your vehicles anti-theft code.



2. On 2005 and earlier vehicles, disconnect the crankcase vent tube from the vent hose junction above the alternator.



2a. On 2006 and later vehicles, disconnect the crankcase vent tube from the rear of the intake manifold.



3. Loosen the intake tube hose clamps and remove the intake tube assembly from the vehicle.

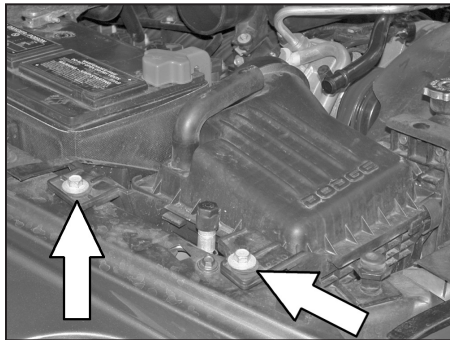

4. Remove the two airbox retaining bolts.



5. Pull up firmly to dislodge the airbox from mounting grommet, and remove the airbox from the vehicle.

NOTE: K&N Engineering, Inc. recommends that customers do not discard factory air intake.

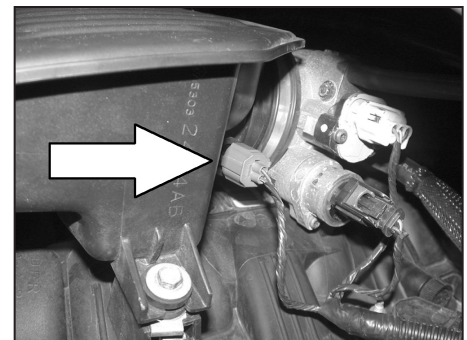

6. Depress the locking tab on the air temp sensor electrical connection and disconnect the air temp electrical connector.



7. Remove the two 10mm resonator retaining bolts, then remove the resonator from the vehicle.

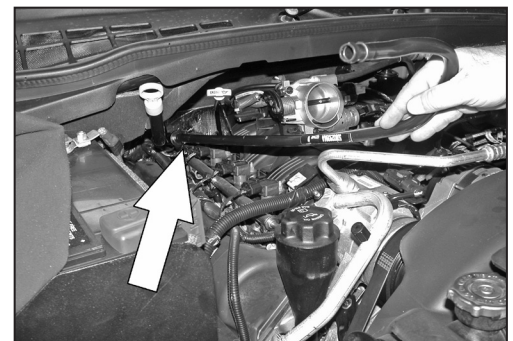

7a. On 2006 and later vehicles, disconnect the crankcase vent tube from the rear of the intake manifold.

NOTE: On 2009 and later vehicles the crankcase vent is attached to the right side valve cover.

Continued

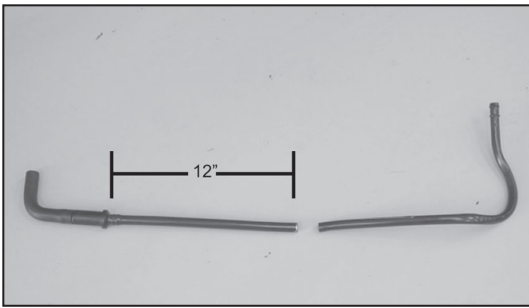

7b. On 2006 and later vehicles, measure 12" from the crankcase check valve and cut the crankcase vent tube as shown.

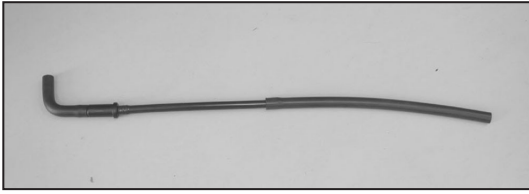

7c. Install the provided silicone hose onto the cut crankcase vent hose as shown and then reconnect the hose assembly onto the intake manifold.

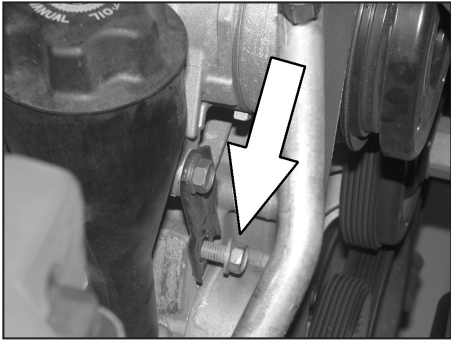

8. Remove the lower A/C bracket bolt shown with a 15mm socket.

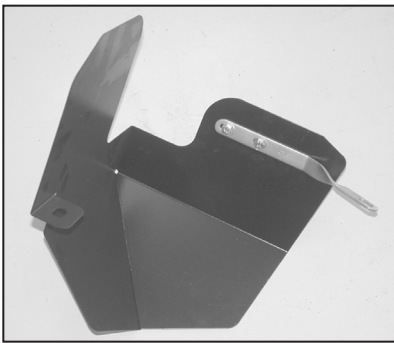

9. Install the heat shield bracket (07197) onto the heat shield with the provided hardware.
NOTE: On 2009 and later model vehicles, it will be necessary to flip the mounting bracket to the outside of the heat shield. The bend angle will be in the opposite direction.

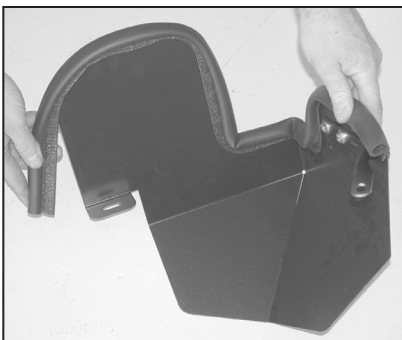

10. Install the provided edge trim onto the heat shield.
NOTE: Some trimming of the edge trim will be necessary.

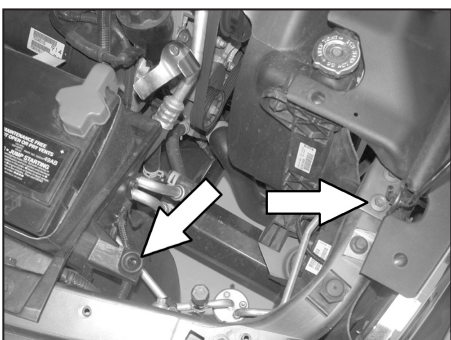

11. On 2008 and earlier models, remove the core support mounting bolt shown with a 13mm wrench, and pull out the stock airbox mounting grommet shown.

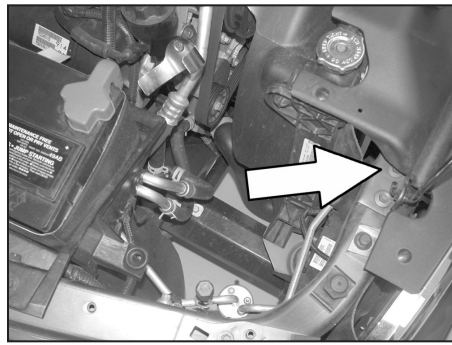

11a. On 2009 and later vehicles, the mounting bolt used has been eliminated. The heat shield bracket will need to move to the left mounting bolt which is under the radiator cover. It may be necessary to loosen the radiator cover.

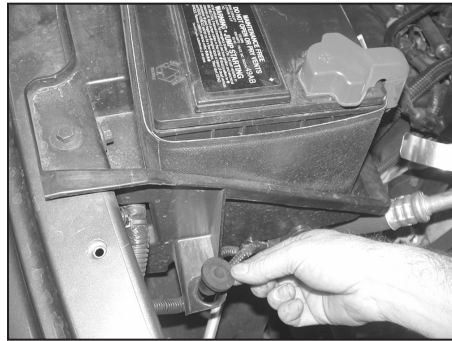

12. Install the 3/8" threaded insert provided into the airbox mounting grommet hole vacated in step #11.

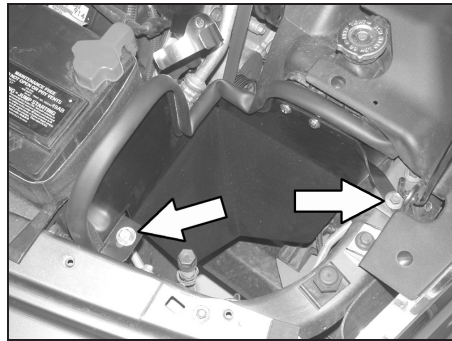

13. On the 2008 and earlier models install the K&N® heat shield assembly and secure the mounting bracket to the radiator core support with original bolt removed in step #11. Secure the rear of the heat shield to the 3/8" threaded insert with the provided hardware.
NOTE: On 2009 and later models secure the mounting bracket to the radiator core support with original bolt removed in step #11a.



14. Install the silicone hose (084091) onto the throttle body and secure with the provided hose clamps.



15. Twist the temp sensor counter clockwise to unlock and remove the temp sensor from the factory resonator.
NOTE: Take care removing the air temperature sensor as it is very fragile.

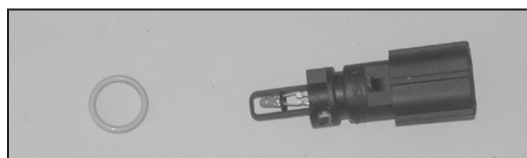

16. Remove the O-ring from the air temp sensor as shown.

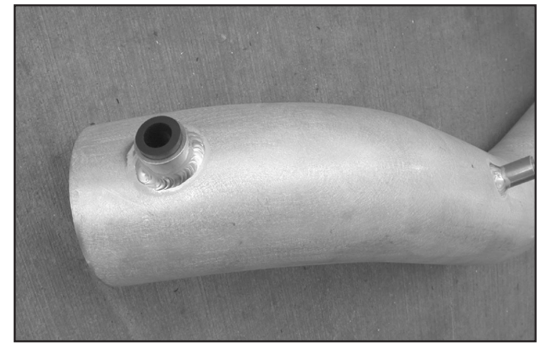

17. Install silicone hose into fitting on the K&N® intake tube as shown.

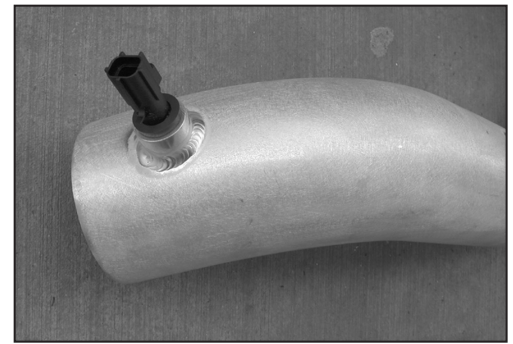

18. Install the air temperature sensor into the vent on the K&N® intake tube as shown.

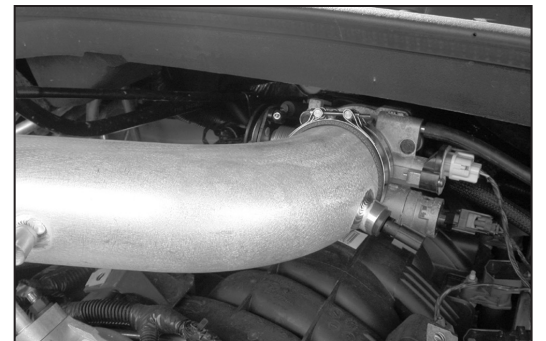

19. Slide the K&N® intake tube into the silicone hose on the throttle body as shown.

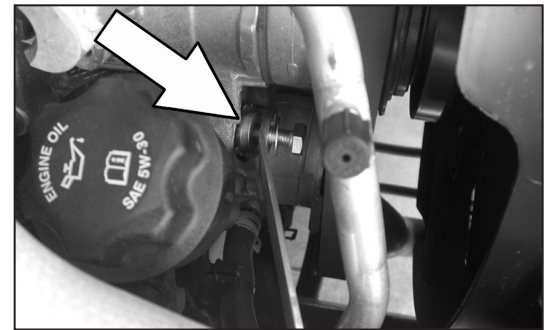

20. Line up the bracket with upper alternator mount and install the provided spacer, washer and hex bolt as shown.

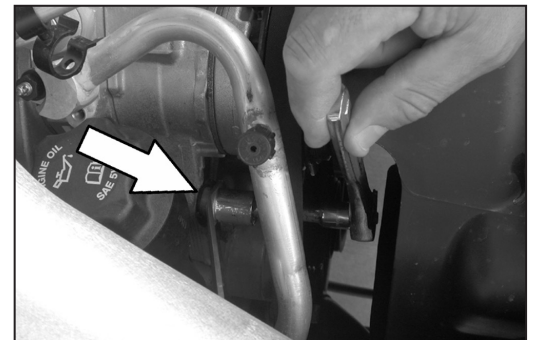

21. Snug the hex bolt but do not tighten completely at this time.

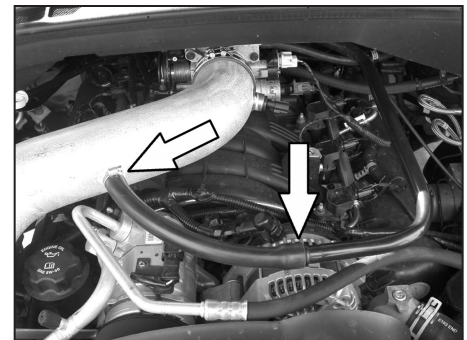

22. On 2005 and earlier vehicles connect the provided silicone hose to the crankcase vent hard line, then connect the other end to the vent on the K&N® intake tube as shown.

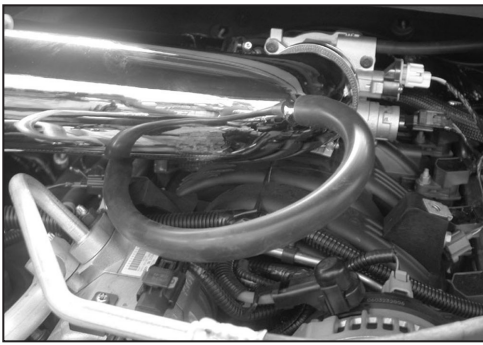

22a. On 2006 and later vehicles connect the crankcase vent hose installed in step #7c to the K&N® intake tube as shown.

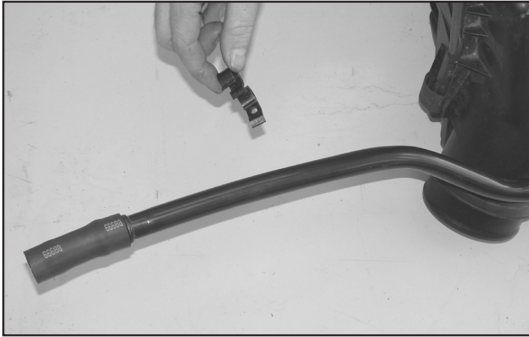

23. On 2005 and earlier vehicles remove the crankcase vent tube mounting clip from the crankcase vent tube on the airbox as shown.



24. On 2005 and earlier vehicles install the crankcase vent tube mounting clip onto the A/C line and crankcase vent tube as shown.



25. Reconnect the air temperature sensor electrical connection as shown.

NOTE: It may be necessary to use the provided temperature sensor wiring harness extension on some models due to factory wiring harness changes.



26. Install the K&N® air filter and secure with the provided hose clamp as shown.

NOTE: Drycharger® air filter wrap; part number RC-3690DK is available to purchase separately. To learn more about Drycharger® filter wraps or look up color availability please visit <http://www.knfilters.com>®.

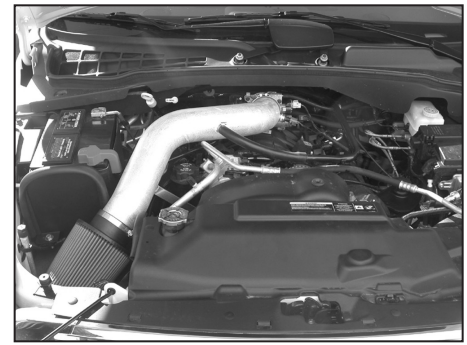

27. Reconnect the negative battery cable and double check to make sure everything is tightened and properly positioned before starting the vehicle.

28. The C.A.R.B. exemption sticker, (attached), must be visible under the hood so that an emissions inspector can see it when the vehicle is required to be tested for emissions. California requires testing every two years, other states may vary.

29. It will be necessary for all K&N® high flow intake systems to be checked periodically for realignment, clearance and tightening of all connections. Failure to follow the above instructions or proper maintenance may void warranty.

ROAD TESTING:

1. Start the engine with the transmission in neutral or park, and the parking brake engaged. Listen for air leaks or odd noises. For air leaks secure hoses and connections. For odd noises, find cause and repair before proceeding. This kit will function identically to the factory system except for being louder and much more responsive.

2. Test drive the vehicle. Listen for odd noises or rattles and fix as necessary.

3. If road test is fine, you can now enjoy the added power and performance from your kit.

4. K&N Engineering, Inc., suggests checking the air filter element periodically for excessive dirt build-up. When the element becomes covered in dirt (or once a year), service it according to the instructions on the Recharger® service kit, part number 99-5050 or 99-5000.

INTAKE SYSTEMS FOR VEHICLES LISTED ARE 50 STATE LEGAL. SEE KNFILTERS.COM FOR CARB STATUS ON EACH PART FOR A SPECIFIC VEHICLE.