



TYPHOON INTAKE SYSTEMS

INTAKE SYSTEMS FOR VEHICLES LISTED ARE 50 STATE LEGAL. SEE KNFILTERS.COM FOR CARB STATUS ON EACH PART FOR A SPECIFIC VEHICLE.

INSTALLATION INSTRUCTIONS

69-4510TS
CHEVROLET
2002-05 Cavalier
L4-2.2L
PONTIAC
2002-04 Sunfire
L4-2.2L

NOTE: Excludes OHV 2.2L Engines for 2002

TOOLS NEEDED:

- 5/16" Socket
- 10mm Socket
- 13mm Socket
- Flat Blade Screwdriver
- Phillips Screwdriver
- Pliers
- Ratchet

PARTS LIST:

Description	Qty.	Part #	Description	Qty.	Part #	Description	Qty.	Part #
A Air Filter	1	RU-4960	G Washer; Fender, SS	1	1-3027	M Bracket; "L" 69-4510, STL, FB/PC	1	070105
B Hose Clamp #44	3	08560	H Nut; 6mm Nylock, SS	1	07512	N Bolt; 6MM-1.00 X 16MM, SS	2	07812
C Intake Tube	1	27165-2	I Grommet; 7/16"ID	1	08092	O Washer; 1/4"ID X 5/8"OD - SAE	3	08275
D Bracket; "C"	1	010046	J Hose Clamp; #006 Mini	2	08407	P Vent; 1/2" Hose, 1/4" NPT	1	080022
E Bolt; M6-1.00 x 16, Btn. Hd.	1	07730	K Hose; 1/2"ID x 19"L, Blk. Silicone	1	084075	Q Vent; 1/4" Hose, 1/4" NPT	1	08046
F Washer; 1/4" Lock, ZN	2	08198	L Hose; 2-3/4"ID Transition, Blk.	1	084082			

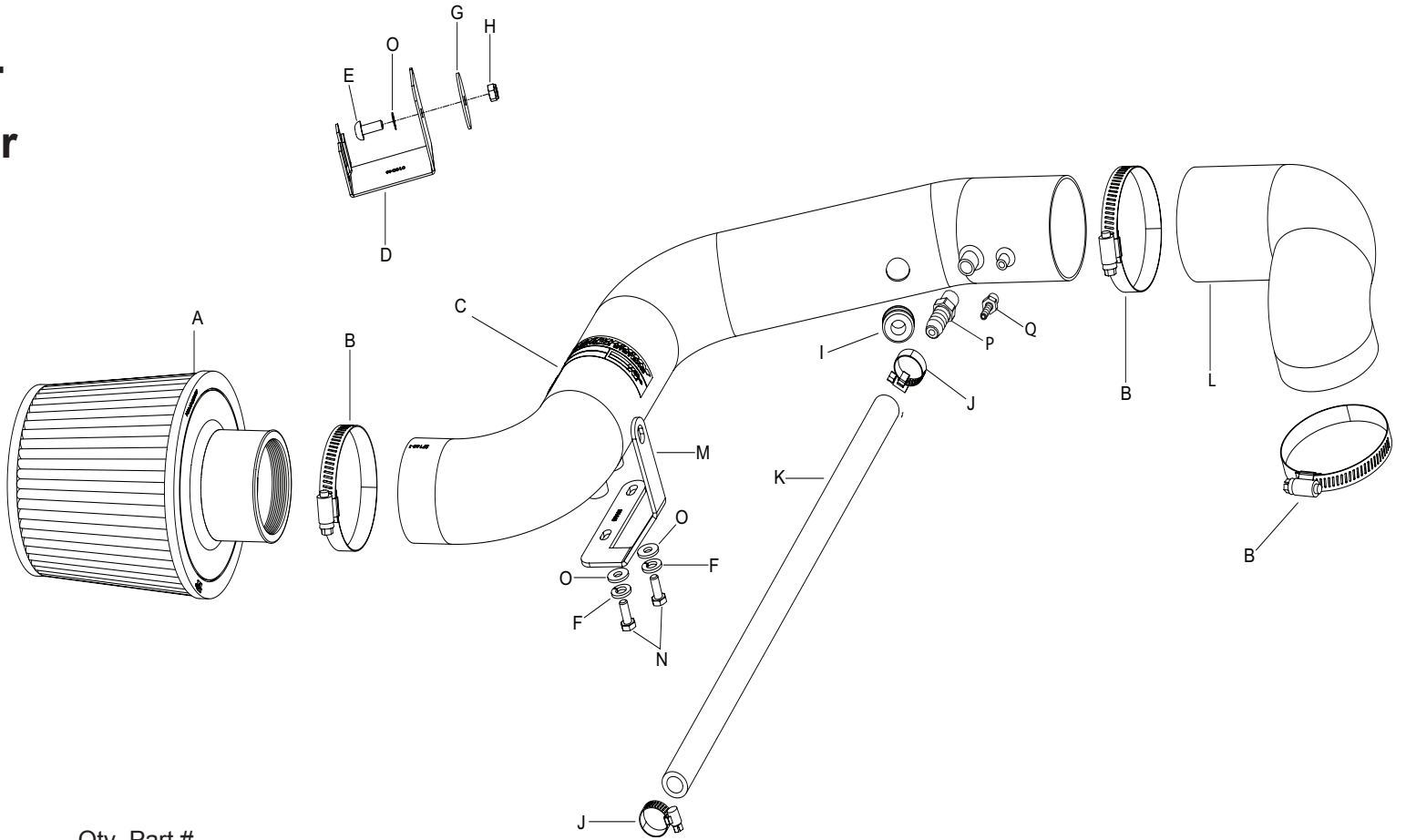

NOTE: FAILURE TO FOLLOW INSTALLATION INSTRUCTIONS AND NOT USING THE PROVIDED HARDWARE MAY DAMAGE THE INTAKE TUBE, THROTTLE BODY AND ENGINE.

TO START:

1. Turn off the ignition and disconnect the negative battery cable.

NOTE: Disconnecting the negative battery cable erases pre-programmed electronic memories. Write down all memory settings before disconnecting the negative battery cable. Some radios will require an anti-theft code to be entered after the battery is reconnected. The anti-theft code is typically supplied with your owner's manual. In the event your vehicles' anti-theft code cannot be recovered, contact an authorized dealership to obtain your vehicles anti-theft code.

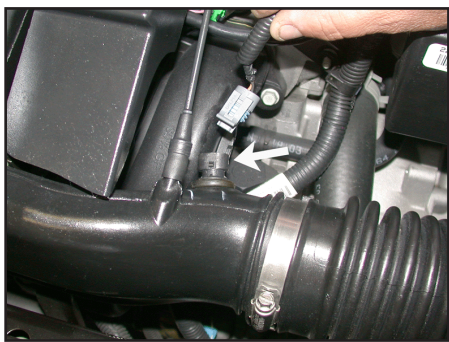

2. Disconnect the air temperature sensor electrical connection as shown.

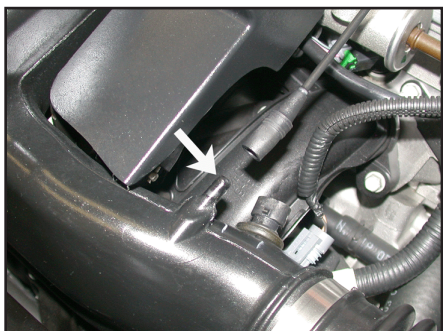

3. Disconnect the vent hose from the stock intake tube as shown.

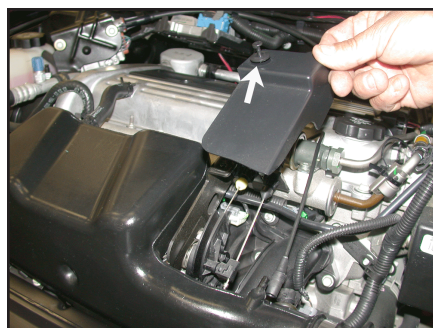

4. Disengage the plastic rivet and remove the throttle cable cover as shown.

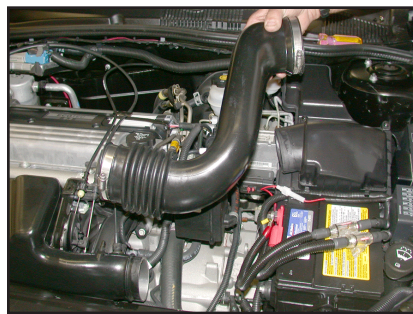

5. Loosen hose clamps and remove the stock intake tube as shown.



6. Loosen the hose clamp on the intake plenum at the throttle body as shown.



7. Remove the crankcase vent hose from the intake plenum as shown.



8. Pull upwards to remove the intake plenum as shown.

NOTE: K&N Engineering, Inc., recommends that customers do not discard factory intake.



9. Remove the air temperature sensor from the intake tube as shown.

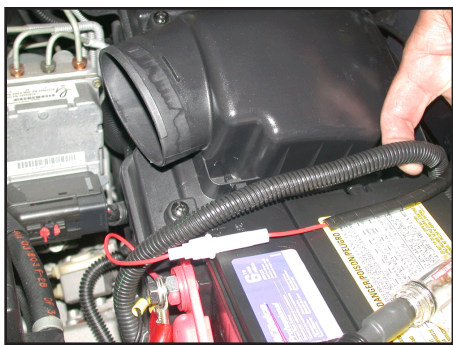

10. Unclip the wire harness from the air cleaner cover as shown.

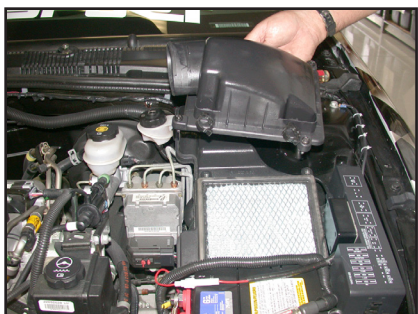

11. Loosen and remove the four air cleaner bolts to remove the air cleaner cover as shown.

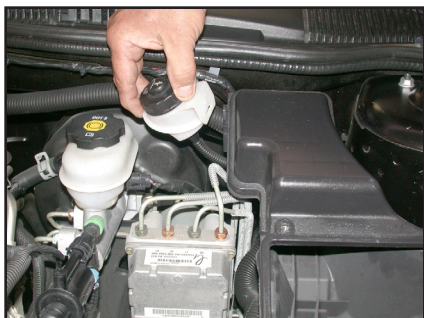

12. On manual transmission vehicles remove the fluid reservoir from the side of the lower air cleaner assembly as shown.



13. Loosen and remove the battery hold down block from the battery tray as shown, and slide the battery forward to create clearance for removal of the lower air cleaner assembly.



14. Disengage the plastic rivet and pull the fuse box upwards as shown.



15. Rotate and pull the lower air cleaner assembly upwards to remove the assembly as shown.

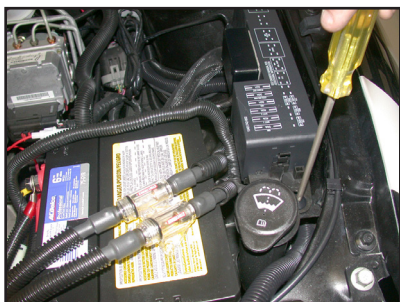

16. Secure the fuse box using the stock plastic rivet as shown.

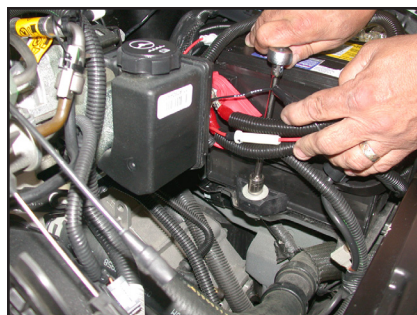

17. Reinstall the battery hold down block as shown.



18. On manual transmission vehicles install the provided reservoir bracket onto the air cleaner locator bracket using the provided hardware as shown.



19. On manual transmission vehicles slide the fluid reservoir onto the bracket from step 18 as shown.



20. Install the silicone hose and hose clamps onto the throttle body as shown.

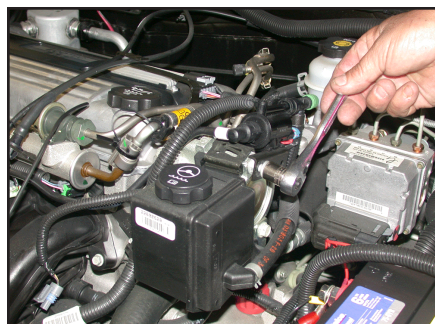

21. Remove the hex nut from the EVAP canister purge solenoid as shown.

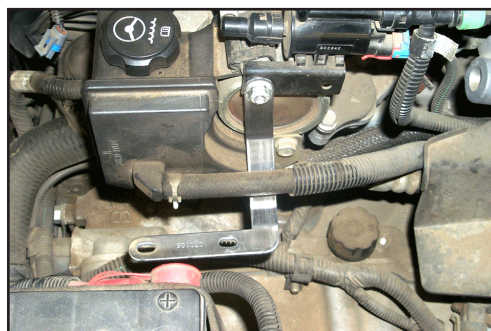

21a. Install the tube mounting bracket (070105) onto the stud and secure with the nut from the previous step.

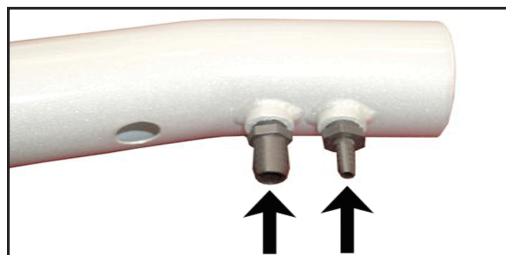

22. Install the two provided 1/4" NPT fittings into the K&N® intake tube as shown.
NOTE: Plastic NPT fittings are easy to cross thread. Install the vent fitting "hand" tight, then turn it two complete turns with a wrench.

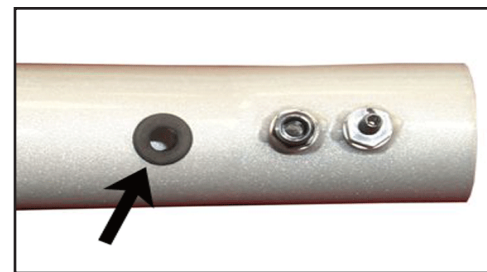

23. Install the provided grommet into the K&N® intake tube as shown.

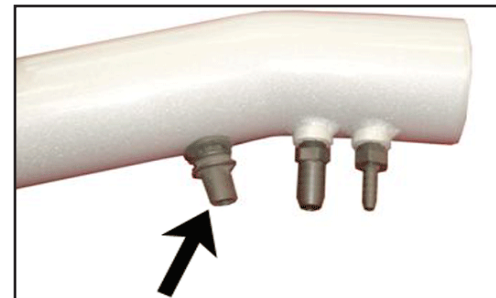

23a. Install the factory inlet air temperature sensor into the grommet installed into the K&N® intake tube in the previous step.



24. Install the K&N® intake tube into the silicone hose at the throttle body and align with the tube mounting bracket installed in step #21a. Secure the intake tube with the provided hose clamp and hardware.

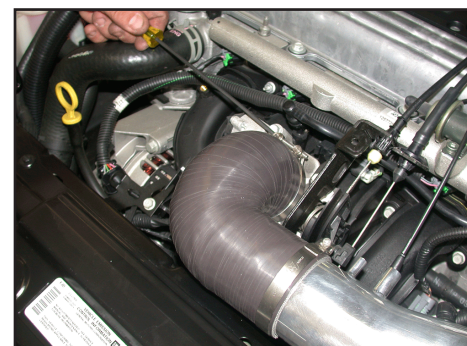

25. Adjust for best fit then tighten the hose clamps on the throttle body/intake tube as shown.

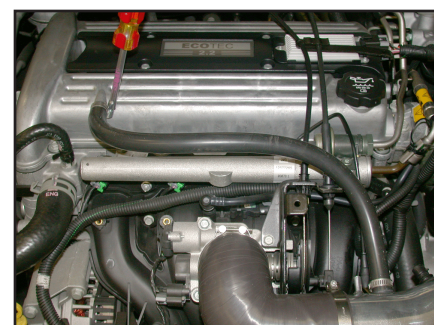

26. Connect the one end of the provided silicone hose to the vent on the cam cover, then, connect the other end to the vent on the K&N® intake tube and secure with the provided hose clamps as shown.

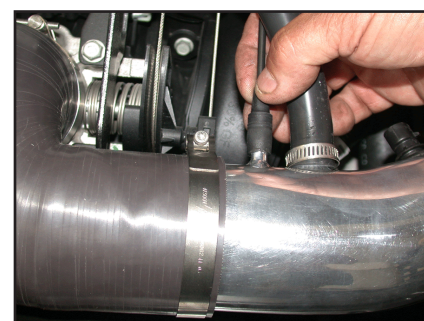

27. Reconnect the vent hose as shown.

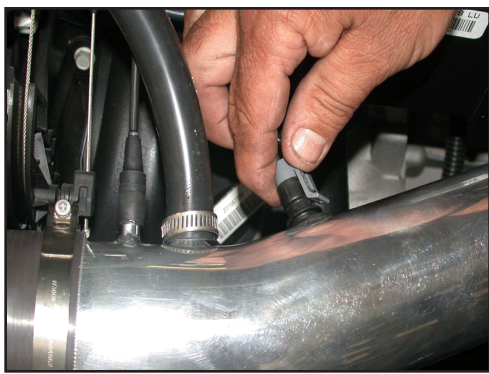

28. Reconnect the air temperature sensor electrical connection as shown.

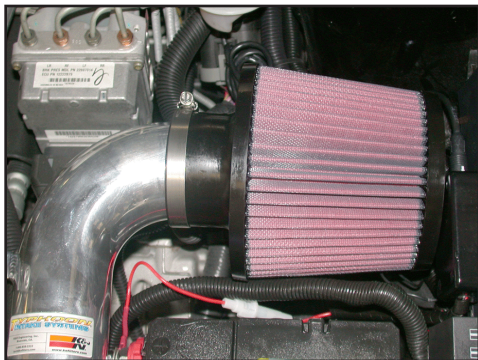

29. Install the K&N® air filter onto the K&N® intake tube and secure with the provided hose clamp as shown.

NOTE: Drycharger® air filter wrap; part # RX-4990DK is available to purchase separately. To learn more about Drycharger® filter wraps or look up color availability please visit <http://www.knfilters.com>®.

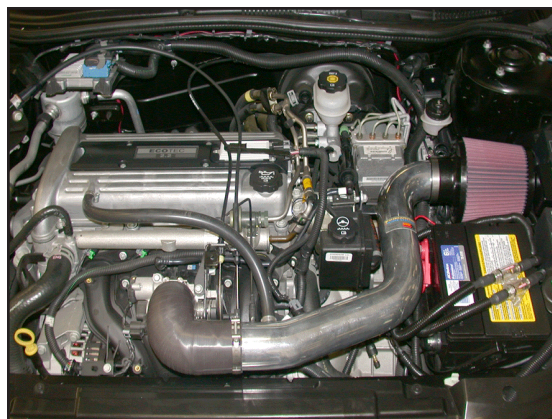

30. Reconnect the vehicle's negative battery cable. Double check to make sure everything is tight and properly positioned before starting the vehicle.

31. The C.A.R.B. exemption sticker, (attached), must be visible under the hood, so the emissions inspector can see it when the vehicle is required to be tested for emissions. California requires testing every two years, other states may vary.

32. It will be necessary for all K&N® high flow intake systems to be checked periodically for realignment, clearance and tightening of all connections. Failure to follow the above instructions or proper maintenance may void warranty.

ROAD TESTING:

1. Start the engine with the transmission in neutral or park, and the parking brake engaged. Listen for air leaks or odd noises. For air leaks secure hoses and connections. For odd noises, find cause and repair before proceeding. This kit will function identically to the factory system except for being louder and much more responsive.

2. Test drive the vehicle. Listen for odd noises or rattles and fix as necessary.

3. If road test is fine, you can now enjoy the added power and performance from your kit.

4. K&N Engineering, Inc., suggests checking the air filter element periodically for excessive dirt build-up. When the element becomes covered in dirt (or once a year), service it according to the instructions on the Recharger® service kit, part number 99-5050 or 99-5000

INTAKE SYSTEMS FOR VEHICLES LISTED ARE 50 STATE LEGAL. SEE KNFILTERS.COM FOR CARB STATUS ON EACH PART FOR A SPECIFIC VEHICLE.

FREE K&N® DECAL To register your warranty, please see us online at knfilters.com/register®. FREE K&N® DECAL