



AIRCHARGER®

HIGH-FLOW INTAKE KITS

NOT LEGAL FOR SALE OR USE ON ANY POLLUTION CONTROLLED MOTOR VEHICLE IN CALIFORNIA OR STATES ADOPTING CALIFORNIA EMISSION PROCEDURES.

See knfilters.com for CARB status on each part for a specific vehicle

INSTALLATION INSTRUCTIONS

63-1116
BMW
2008-13 M3
V8-4.0L

TOOLS NEEDED:

- flat blade screw driver
- 4mm allen key
- 10mm wrench
- 10mm socket
- ratchet
- extension

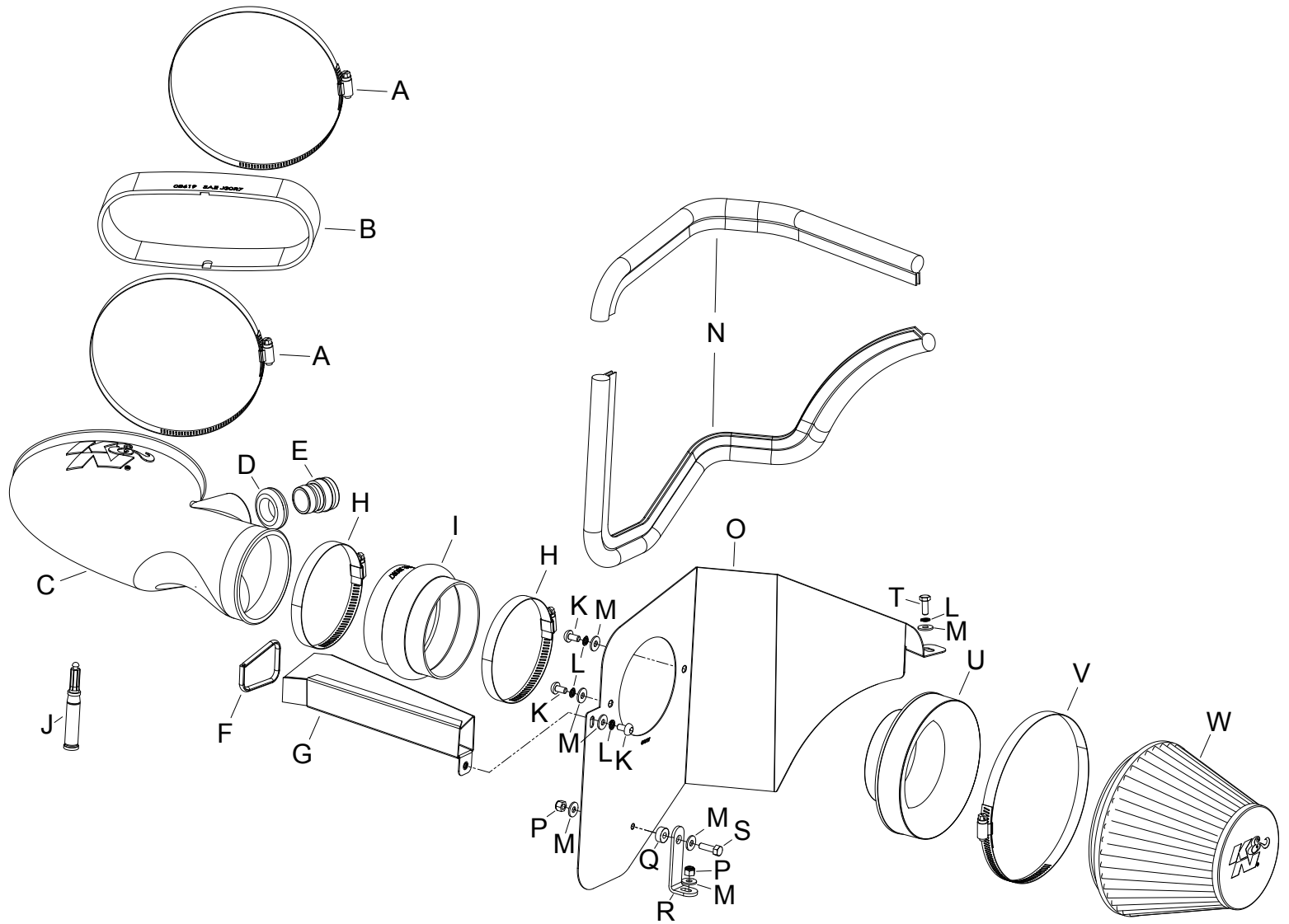

PARTS LIST:

Description	Qty.	Part #	Description	Qty.	Part #	Description	Qty.	Part #
A HOSE CLAMP #116, BLACK	2	08647K	I HOSE; 4" ID X 3" L HUMP	1	08418	Q SPACER: .625" OD X .250"ID	1	06555
B HOSE; 3" X 8-3/4" ID X 1-3/4" L	1	08619	J SUPER GLUE, 3G DRIP	1	409	R BRACKET; "L", 69-8619, STL	1	083170
C INTAKE TUBE (KF)	1	087300A	K BOLT; M6 X 1.00" 12MM, SS	3	07794	S BOLT; M6 X 1.00" X 20MM HEX	1	07795
D GROMMET; 1-3/4"OD, 1"ID	1	082000	L WASHER, M6 SPLIT LOCK ZINC	4	1-3025	T BOLT; 6MM-1.00 X 16MM, SS	1	07812
E ADAPTOR; 1-1/8"OD QUICK	1	088012	M WASHER; 6MM FLAT, SS	7	08269	U ADAPTOR; 57-3058 #454	1	27300
F EDGE TRIM; 1/16"GAP, 7"L	1	102452	N EDGE TRIM (50")	1	102481	V HOSE CLAMP #104, BLACK	1	08697K
G FRESH AIR DUCT; 63-1116	1	073198	O HEAT SHIELD	1	073197	W AIR FILTER	1	RC-5138
H HOSE CLAMP #64, BLACK ZINC	2	08645K	P NUT; 6MM NYLOCK, HEXHEAD	2	07512			

NOTE: FAILURE TO FOLLOW INSTALLATION INSTRUCTIONS AND NOT USING THE PROVIDED HARDWARE MAY DAMAGE THE INTAKE TUBE, THROTTLE BODY AND ENGINE.

TO START:

1. Turn off the ignition and disconnect the negative battery cable.
NOTE: Disconnecting the negative battery cable erases pre-programmed electronic memories. Write down all memory settings before disconnecting the negative battery cable. Some radios will require an anti-theft code to be entered after the battery is reconnected. The anti-theft code is typically supplied with your owner's manual. In the event your vehicles anti-theft code cannot be recovered, contact an authorized dealership to obtain your vehicles anti-theft code.

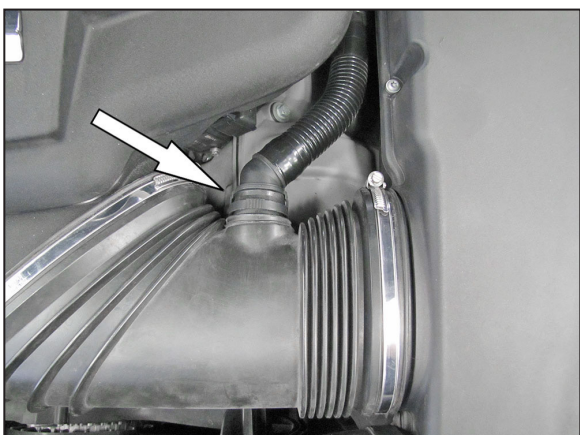

2. Release the locking ring securing the crank case vent to the intake tube and then disconnect the crank case vent hose from the intake tube

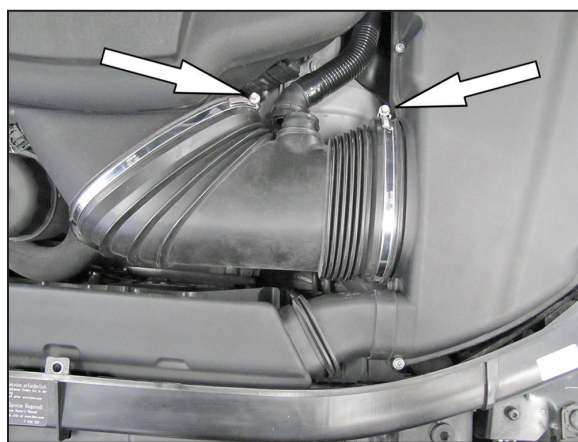

3. Loosen the Hose clamps securing the intake hose and then remove the intake hose from the vehicle.

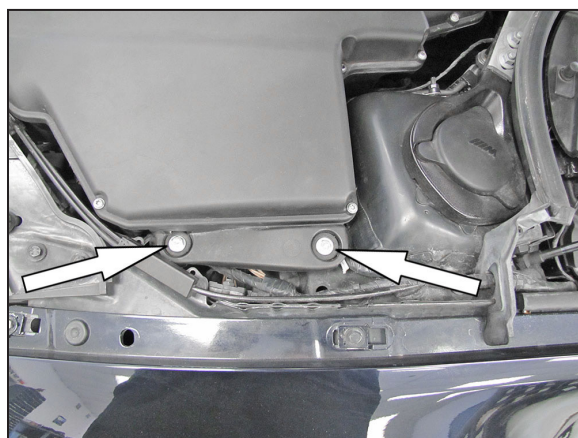

4. Remove the two bolts securing the factory air box to the inner fender.



5. Lift up the factory air filter housing and fresh air intake duct and remove them from the vehicle.
NOTE: K&N Engineering, Inc., recommends that customers do not discard factory air intake.

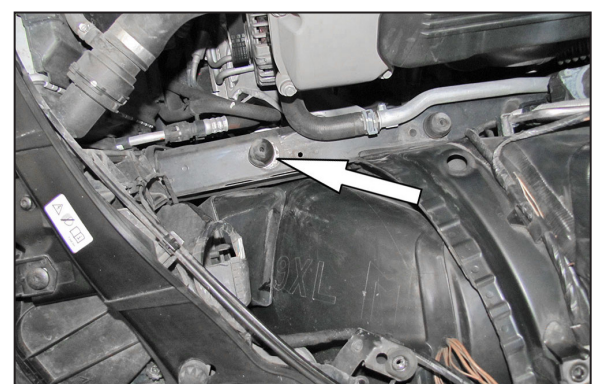

6. Remove the lower air filter mount from the frame rail.

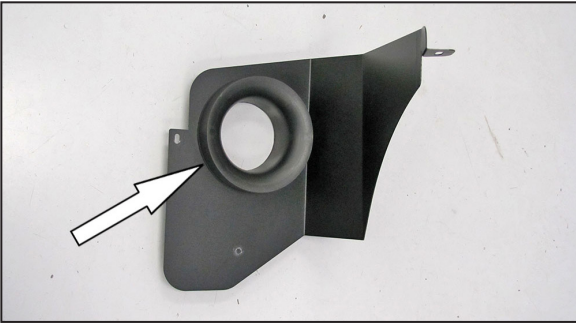

7. Install the filter adapter into the K&N® heat shield and secure with the provided hardware.

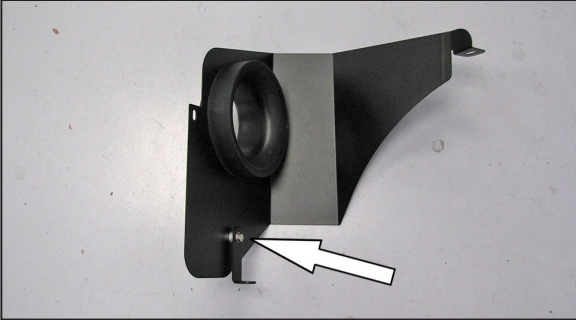

8. Install the heat shield mounting bracket (083170) onto the heat shield and secure with the provided hardware.

NOTE: be sure to place the provided spacer between the bracket and heat shield.

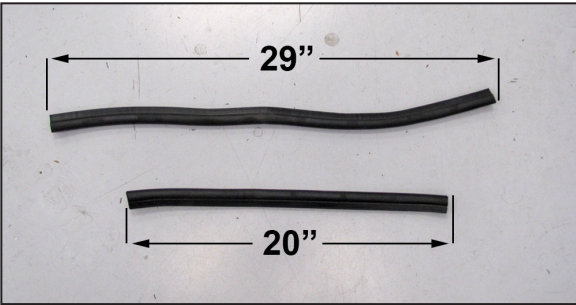

9. Cut the provided edge trim into two sections, one will be 29" long and the other will be 20" long.

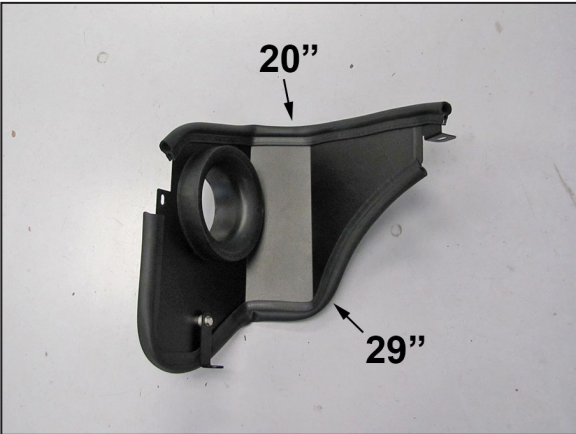

10. Install the edge trim onto the heat shield as shown.

NOTE: Use the provided superglue to hold down the short ends on the corners.

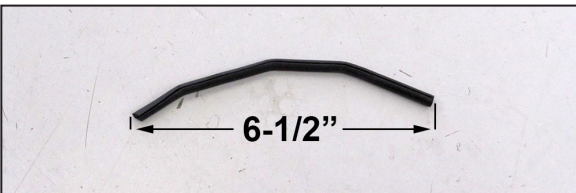

11. Cut the provided small edge trim to the length of 6-1/2".



12. Install the small edge trim onto the K&N® fresh air duct as shown.

NOTE: Use the provided superglue to secure the edge trim.



13. Install the fresh air duct onto the heat shield and secure with the provided hardware then install the heat shield assembly onto the air filter housing mounting studs but do not secure at this time.

NOTE: The K&N® fresh air duct will insert into the factory fresh air scoop.



14. Install the provided grommet and quick disconnect fitting into the K&N® intake tube as shown.

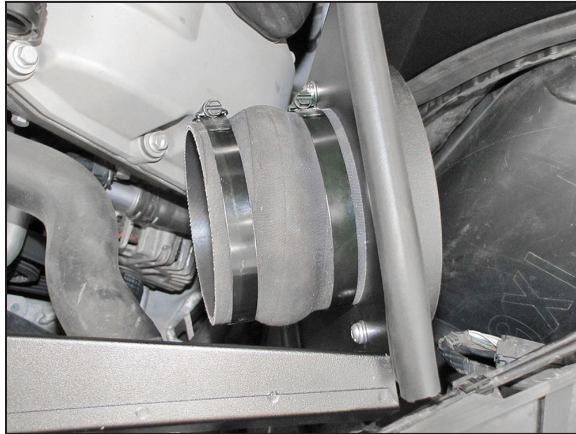

15. Install the provided coupling hose (08418) onto the filter adapter and secure with the provided hose clamp.



16. Install the provided coupling hose (08619) onto the K&N® intake tube and slide it as far as possible on.



17. Install the K&N® intake tube into the hose at the filter adapter and then align with the throttle body. Slide the hose back onto the throttle body, align the tube for best fit and then secure the hose clamps.

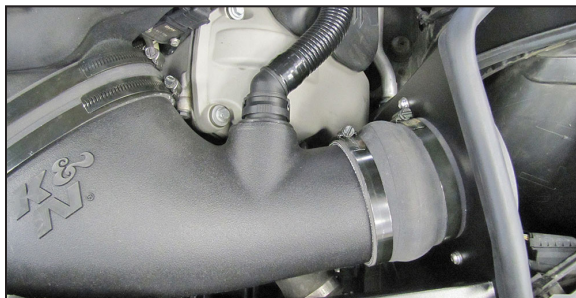

18. Connect the crank case vent hose to the quick disconnect fitting on the K&N® intake tube.

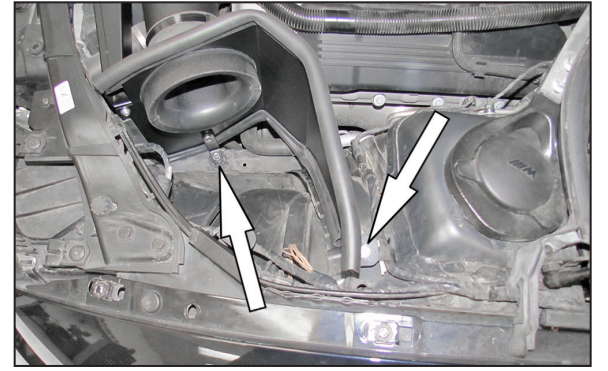

19. Secure the heat shield to the air filter housing studs with the provided hardware.

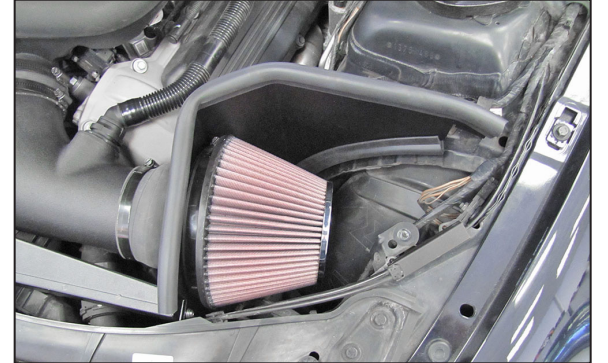

20. Install the K&N® air filter and secure with the provided hose clamp.

NOTE: Drycharger® air filter wrap; part # 22-8049DK is available to purchase separately. To learn more about Drycharger® filter wraps or look up color availability please visit <http://www.knfilters.com>®.



21. Reconnect the vehicle's negative battery cable. Double check to make sure everything is tight and properly positioned before starting the vehicle.

22. It will be necessary for all K&N® high flow intake systems to be checked periodically for realignment, clearance and tightening of all connections. Failure to follow the above instructions or proper maintenance may void warranty.

ROAD TESTING:

1. Start the engine with the transmission in neutral or park, and the parking brake engaged. Listen for air leaks or odd noises. For air leaks secure hoses and connections. For odd noises, find cause and repair before proceeding. This kit will function identically to the factory system except for being louder and much more responsive.

2. Test drive the vehicle. Listen for odd noises or rattles and fix as necessary.

3. If road test is fine, you can now enjoy the added power and performance from your kit.

4. K&N Engineering, Inc., requires cleaning the intake system's air filter element every 100,000 miles. When used in dusty or off-road environments, our filters will require cleaning more often. We recommend that you visually inspect your filter once every 25,000 miles to determine if the screen is still visible. When the screen is no longer visible some place on the filter element, it is time to clean it. To clean and re-oil, purchase our filter Recharger® service kit, part number 99-5050 or 99-5000 and follow the easy instructions.

NOT LEGAL FOR SALE OR USE ON ANY POLLUTION CONTROLLED MOTOR VEHICLE IN CALIFORNIA OR STATES ADOPTING CALIFORNIA EMISSION PROCEDURES.

See knfilters.com for CARB status on each part for a specific vehicle