



INTAKE SYSTEMS FOR VEHICLES LISTED ARE 50 STATE LEGAL. SEE KNFILTERS.COM FOR CARB STATUS ON EACH PART FOR A SPECIFIC VEHICLE.

INSTALLATION INSTRUCTIONS

57-9019
TOYOTA
2000-02 Tundra
V6-3.4L

NOTE: This kit was not designed to fit vehicles with a body lift.

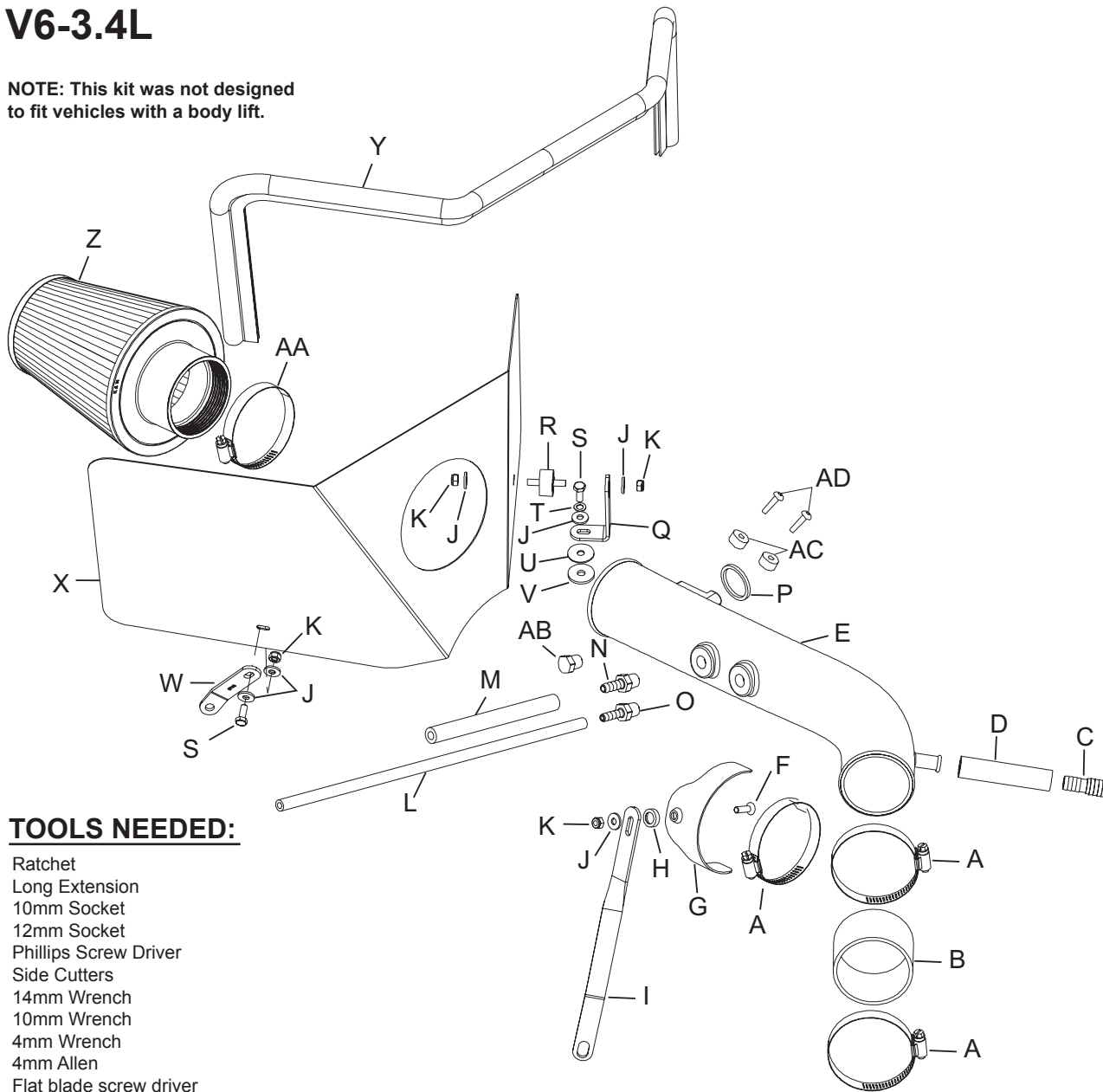

PARTS LIST:

Description	Qty.	Part #
A	3	08577
B	1	08756
C	1	08726
D	1	087028
E	1	087200
F	1	08376
G	1	078855
H	1	08180
I	1	070561
J	6	08275
K	4	07553
L	1	08170
M	1	084020
N	1	08908
O	1	08046
P	1	09013
Q	1	070742
R	1	07027
S	2	07703
T	1	08174
U	1	08160
V	1	21685
W	1	07135
X	1	07461
Y	1	102486
Z	1	RC-4700
AA	1	08601
AB	1	08032
AC	2	06531
AD	2	07793

TOOLS NEEDED:

- Ratchet
- Long Extension
- 10mm Socket
- 12mm Socket
- Phillips Screw Driver
- Side Cutters
- 14mm Wrench
- 10mm Wrench
- 4mm Wrench
- 4mm Allen
- Flat blade screw driver

NOTE: FAILURE TO FOLLOW INSTALLATION INSTRUCTIONS AND NOT USING THE PROVIDED HARDWARE MAY DAMAGE THE INTAKE TUBE, THROTTLE BODY AND ENGINE.

TO START:

1. Turn off the ignition and disconnect the negative battery cable.
NOTE: Disconnecting the negative battery cable erases pre-programmed electronic memories. Write down all memory settings before disconnecting the negative battery cable. Some radios will require an anti-theft code to be entered after the battery is reconnected. The anti-theft code is typically supplied with your owner's manual. In the event your vehicles' anti-theft code cannot be recovered, contact an authorized dealership to obtain your vehicles anti-theft code.



2. Disconnect the mass air sensor.

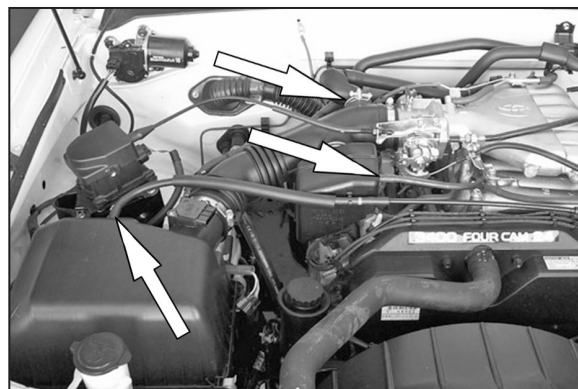

3. Disconnect the three hoses from the air box resonator and intake hose.
NOTE: On 03 models, vehicles come equipped with only two vacuum lines.

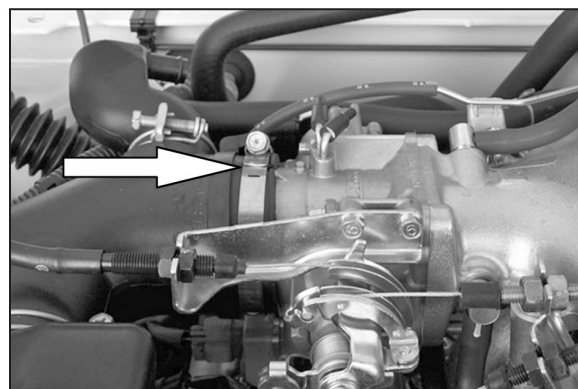

4. Loosen the hose clamp at the throttle body.

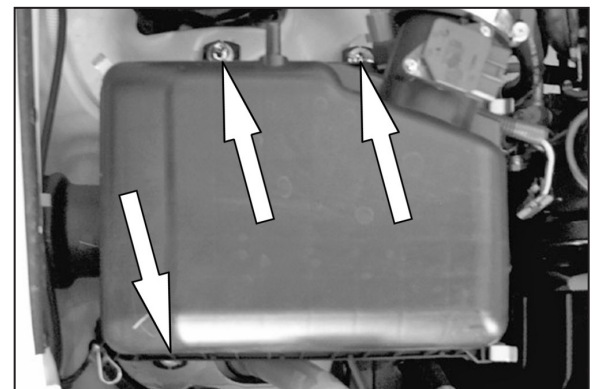

5. Loosen the three bolts that retain the air box assembly.

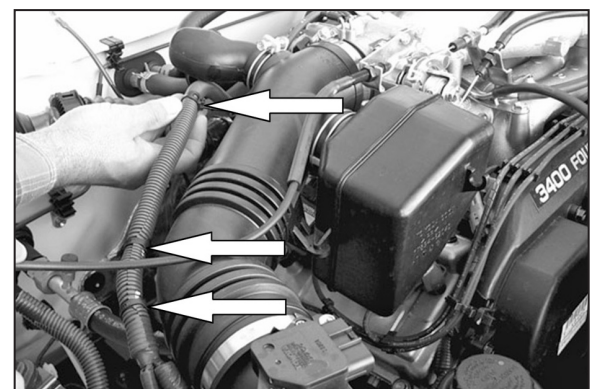

6. Remove the three clips that hold the electrical loom to the intake tube as shown.



7. Remove the complete air intake system.
NOTE: K&N Engineering, Inc., recommends that customers do not discard factory air intake.



8. Loosen and remove the screws that secure the mass air sensor, then remove the mass air sensor.

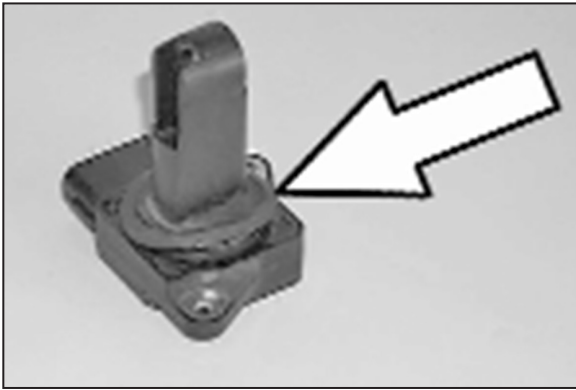

9. Apply the provided gasket to the mass air sensor with the sticky side down.

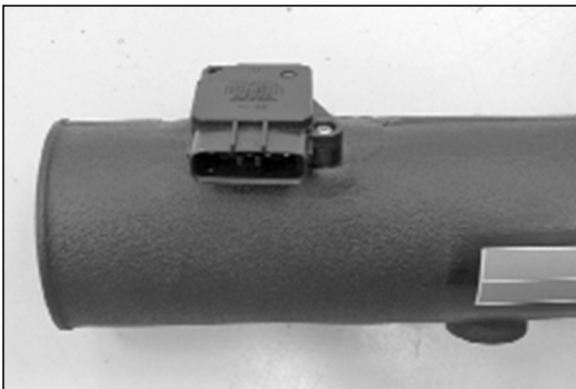

10. Install the mass air sensor into the K&N® intake tube using screws and spacers provided.



11. On 2000-02 models, install provided vents into the K&N® intake tube as shown.
NOTE: Plastic NPT fittings are easy to cross thread. Install the vent fitting "hand" tight, then turn it two complete turns with a wrench.



12. On 03 models, install provided vent and plug into the K&N® intake tube as shown.

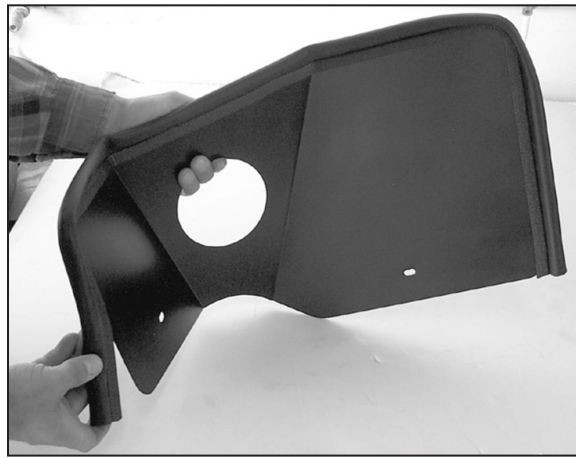

13. Install the edge trim onto the heat shield as shown above. Trim if needed.

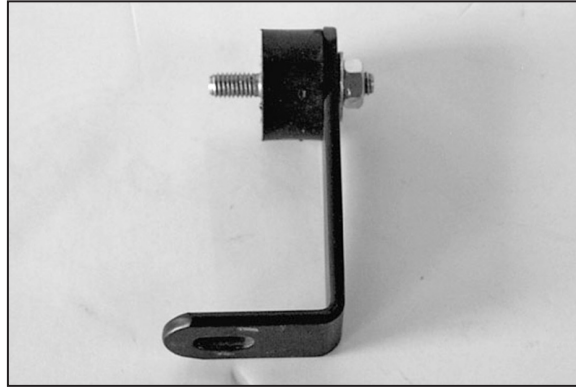

14. Assemble the "L" bracket and rubber mounted stud as shown.



15. Install the "L" bracket onto the existing air box-mounting hole.
NOTE: Rubber washer & fender washer should be mounted between the fender and the bracket. Do not tighten completely.

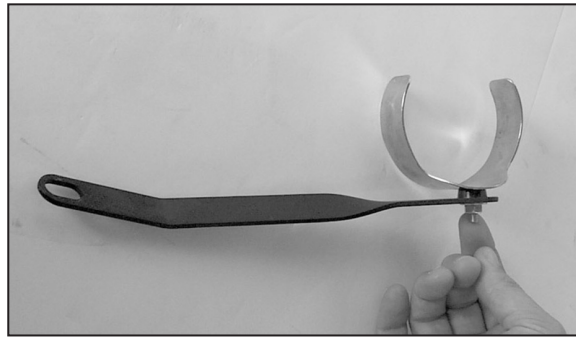

16. Assemble the saddle bracket as shown.

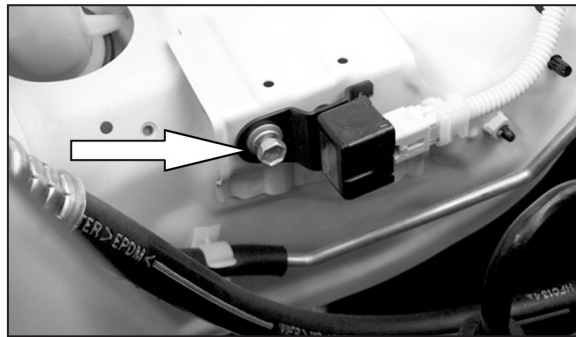

17. Remove the bolt from the relay bracket as shown.



18. Install the bracket onto the relay bracket using the bolt that was removed in step 17. Do not tighten completely.

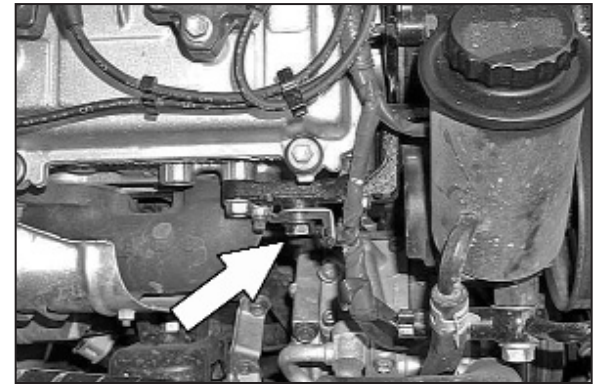

18a. On 2000-02 models, loosen and remove the bolt that secures the wire harness bracket located directly behind the power steering reservoir.

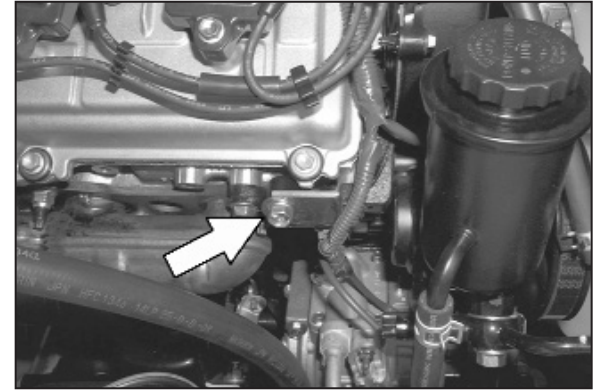

18b. On 2003 models, loosen and remove the bolt that secures the wire harness bracket located directly behind the power steering reservoir.

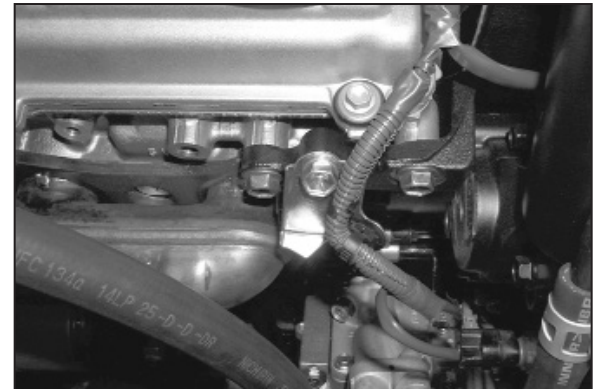

18c. On 2003 models, remove wire harness from bracket then turn bracket over and mount to engine as shown, then re-install wire harness.

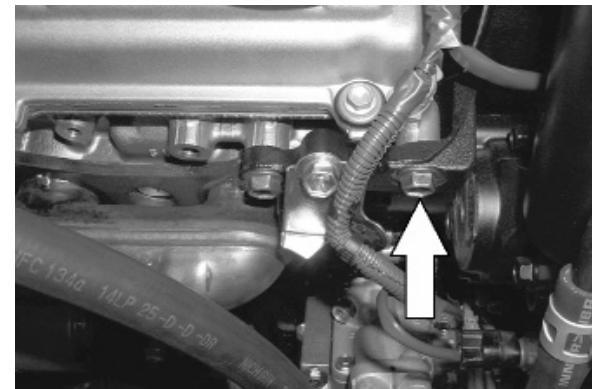

18d. On 2003 models, remove the bolt from power steering bracket as shown

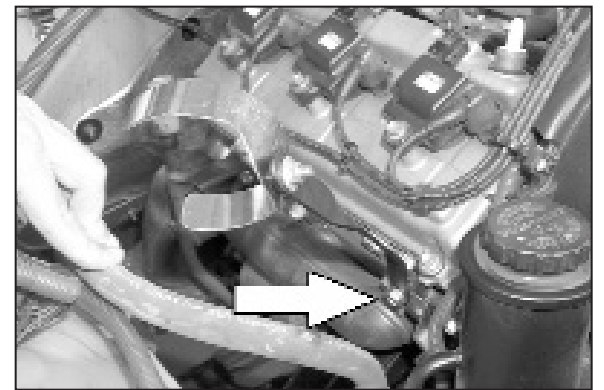

19. Install the saddle bracket assembly onto the motor using the bolt from step 18. Do not tighten completely.



20. Install the heat shield and secure it to the new K&N® brackets with the hardware provided. Do not tighten completely.

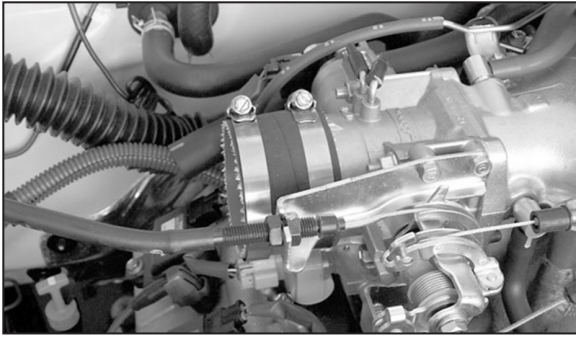

21. Install the silicone hose and hose clamps onto the throttle body as shown.



22. Install the K&N® intake tube onto the throttle body then tighten the hose clamps at the throttle body and saddle bracket.

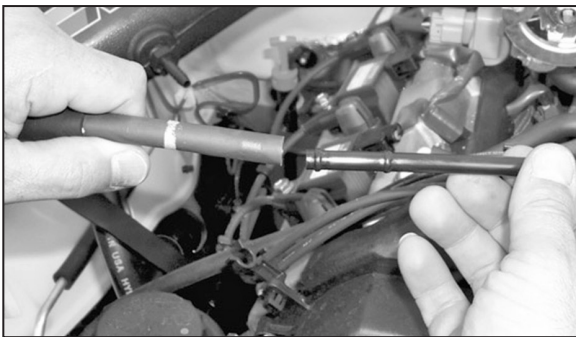

23. On 2000-02 models, remove the rubber hose from the hard plastic vent line as shown.

NOTE: 2003 models will not come equipped with this vent line.

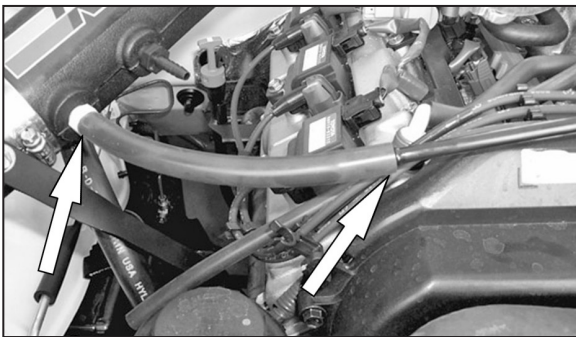

24. On 2000-02 models, install the provided silicone hose onto the K&N® intake tube and connect the other end to the hard vent line as shown.

NOTE: 2003 models will not come equipped with this vent line.

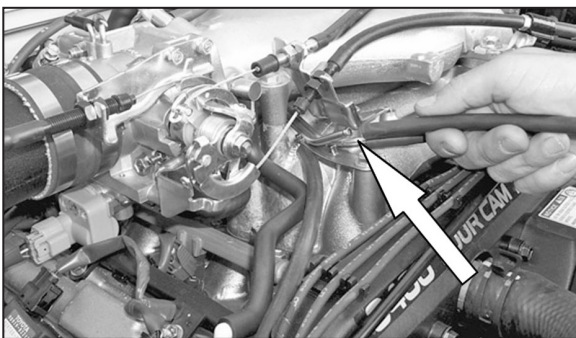

25. Remove the rubber hose from the intake manifold as shown.

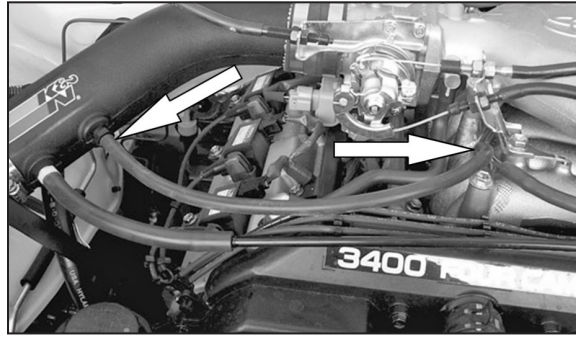

26. Install the new silicone hose onto the K&N® intake tube and then install the other end onto the intake manifold as shown.

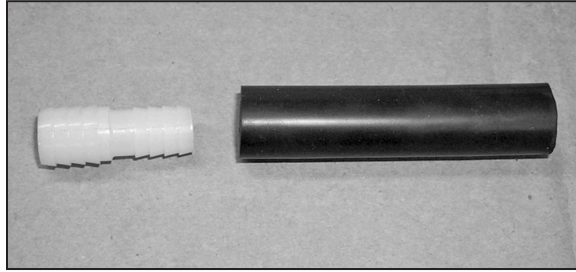

27. Install the hose mender onto the provided silicone hose as shown.

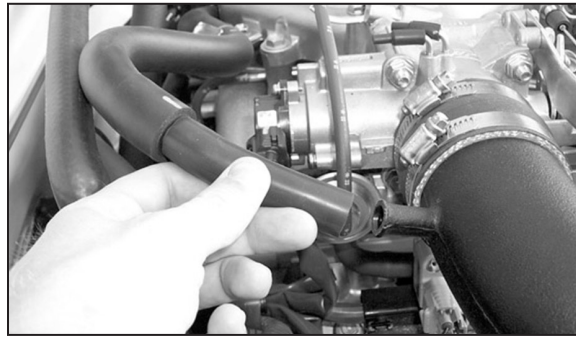

28. Connect the silicone hose to the crankcase vent line then connect the silicone hose to the K&N® intake tube as shown.

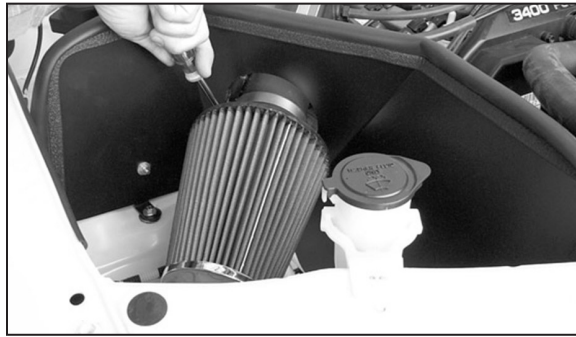

29. Install the K&N® air filter onto the K&N® intake tube and secure it with the provided hose clamp.

NOTE: Drycharger® air filter wrap; part # RC-4700DK is available to purchase separately. To learn more about Drycharger® filter wraps or look up color availability please visit <http://www.knfilters.com>®.



30. Reconnect the mass air sensor.



31. Reconnect the vehicle's negative battery cable. Double check to make sure everything is tight and properly positioned before starting the vehicle.

32. The C.A.R.B. exemption sticker, (attached), must be visible under the hood so that an emissions inspector can see it when the vehicle is required to be tested for emissions. California requires testing every two years, other states may vary.

33. It will be necessary for all K&N® high flow intake systems to be checked periodically for realignment, clearance and tightening of all connections. Failure to follow the above instructions or proper maintenance may void warranty.

ROAD TESTING:

1. Start the engine with the transmission in neutral or park, and the parking brake engaged. Listen for air leaks or odd noises. For air leaks secure hoses and connections. For odd noises, find cause and repair before proceeding. This kit will function identically to the factory system except for being louder and much more responsive.

2. Test drive the vehicle. Listen for odd noises or rattles and fix as necessary.

3. If road test is fine, you can now enjoy the added power and performance from your kit.

4. K&N Engineering, Inc., requires cleaning the intake system's air filter element every 100,000 miles. When used in dusty or off-road environments, our filters will require cleaning more often. We recommend that you visually inspect your filter once every 25,000 miles to determine if the screen is still visible. When the screen is no longer visible some place on the filter element, it is time to clean it. To clean and re-oil, purchase our filter Recharger® service kit, part number 99-5050 or 99-5000 and follow the easy instructions.

INTAKE SYSTEMS FOR VEHICLES LISTED ARE 50 STATE LEGAL. SEE KNFILTERS.COM FOR CARB STATUS ON EACH PART FOR A SPECIFIC VEHICLE.