



INTAKE SYSTEMS FOR VEHICLES LISTED ARE 50 STATE LEGAL. SEE KNFILTERS.COM FOR CARB STATUS ON EACH PART FOR A SPECIFIC VEHICLE.

INSTALLATION INSTRUCTIONS

57-3515
HONDA
2006-08 Ridgeline
V6-3.5L

NOTE: This kit was not designed to fit vehicles with a body lift.

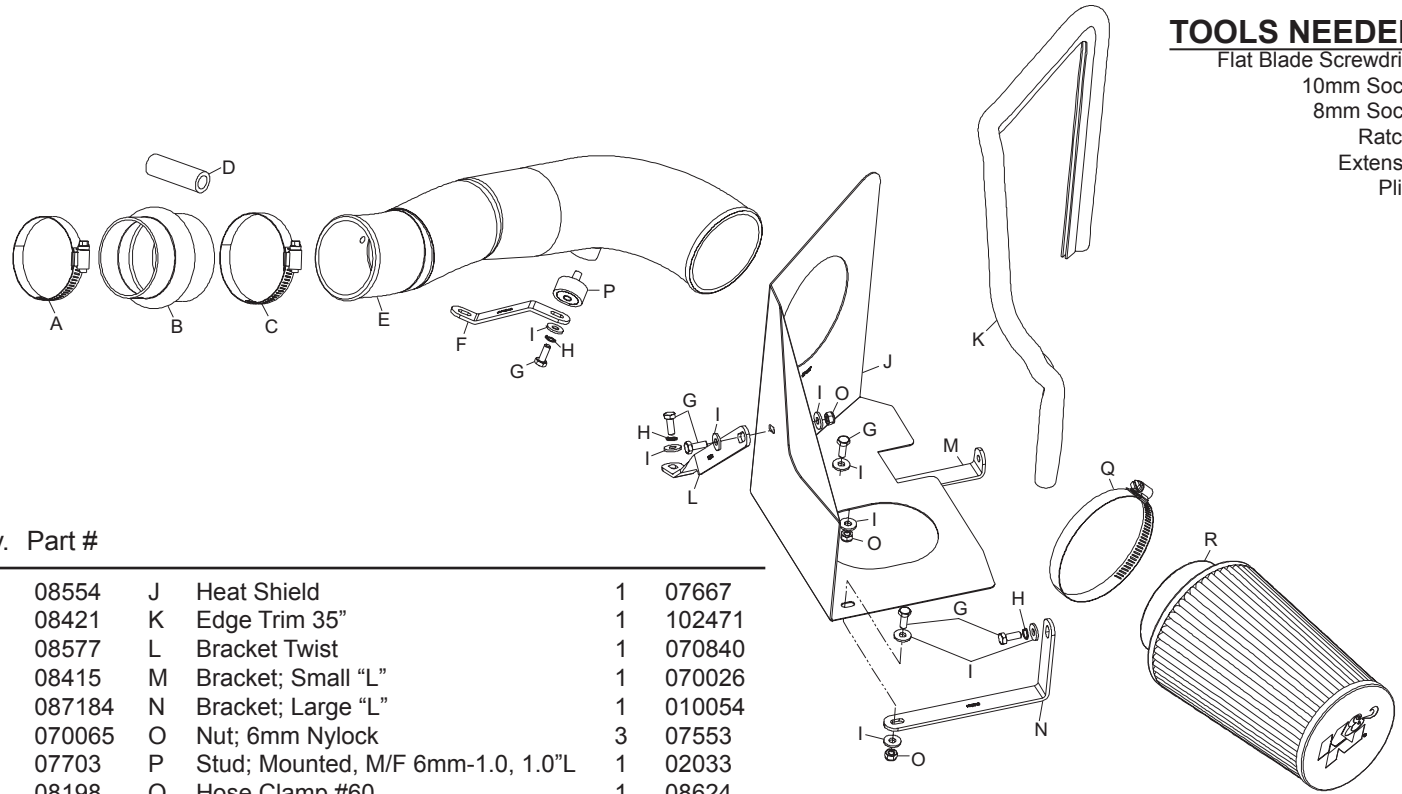

TOOLS NEEDED:
 Flat Blade Screwdriver
 10mm Socket
 8mm Socket
 Ratchet
 Extension
 Pliers

PARTS LIST:

Description	Qty.	Part #
A Hose Clamp #40	1	08554
B Hose; 2.75"ID To 3.0"ID X 3.0"L, Hump	1	08421
C Hose Clamp #44	1	08577
D Hose; 1/2"ID X 2.38"L	1	08415
E Intake Tube	1	087184
F Bracket; "Z"	1	070065
G Bolt; 6mm-1.00 X 16mm, Hex	6	07703
H Washer; 1/4"ID Split Lock	3	08198
I Washer; 1/4"ID X 5/8" OD	9	08275
J Heat Shield	1	07667
K Edge Trim 35"	1	102471
L Bracket Twist	1	070840
M Bracket; Small "L"	1	070026
N Bracket; Large "L"	1	010054
O Nut; 6mm Nylock	3	07553
P Stud; Mounted, M/F 6mm-1.0, 1.0"L	1	02033
Q Hose Clamp #60	1	08624
R Air Filter	1	RC-4760

NOTE: FAILURE TO FOLLOW INSTALLATION INSTRUCTIONS AND NOT USING THE PROVIDED HARDWARE MAY DAMAGE THE INTAKE TUBE, THROTTLE BODY AND ENGINE.

TO START:

1. Turn off the ignition and disconnect the negative battery cable.
NOTE: Disconnecting the negative battery cable erases pre-programmed electronic memories. Write down all memory settings before disconnecting the negative battery cable. Some radios will require an anti-theft code to be entered after the battery is reconnected. The anti-theft code is typically supplied with your owner's manual. In the event your vehicles' anti-theft code cannot be recovered, contact an authorized dealership to obtain your vehicles anti-theft code.

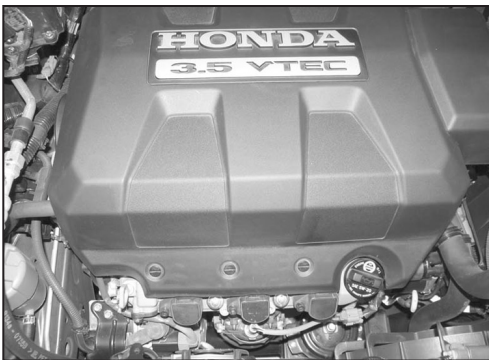

2. Turn the three-engine cover retaining screws 1/4 turn counter clockwise to unlock the cover from the engine.



3. Lift the engine cover up to dislodge it from the mounting grommets and then remove it from the engine as shown.

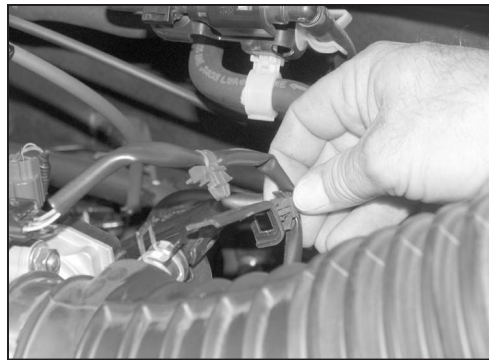

4. Unhook the wiring harness retaining clips as shown.

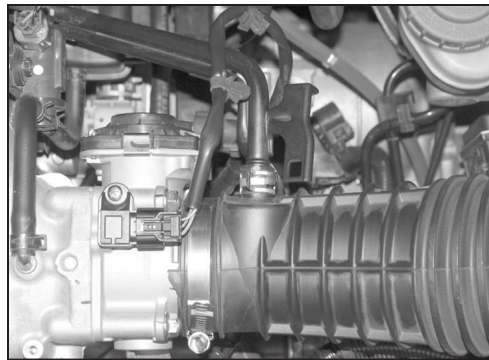

5. Using a pair of pliers, release the crankcase vent tube clamp and then disconnect the crankcase vent tube from the intake tube.



6. Loosen the hose clamp, which secures the intake tube to the throttle body.

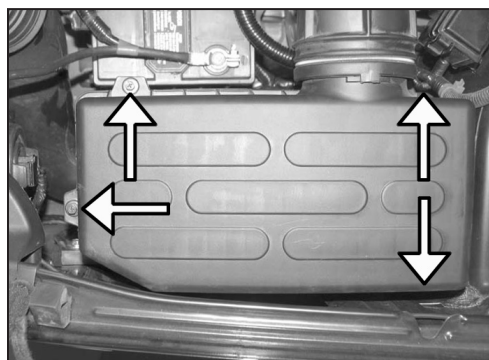

7. Loosen the four airbox lid retaining bolts shown.

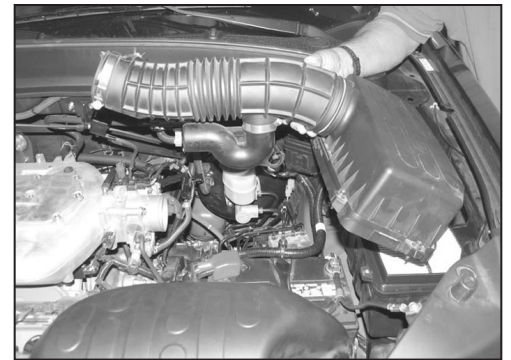

8. Remove the airbox lid and intake tube as shown.



9. Remove the two lower airbox retaining bolts shown.



10. Remove the lower airbox housing as shown. **NOTE: K&N Engineering, Inc., recommends that customers do not discard factory air intake.**



11. Remove the fresh air duct retaining bolt shown. **NOTE: This bolt will be reused.**

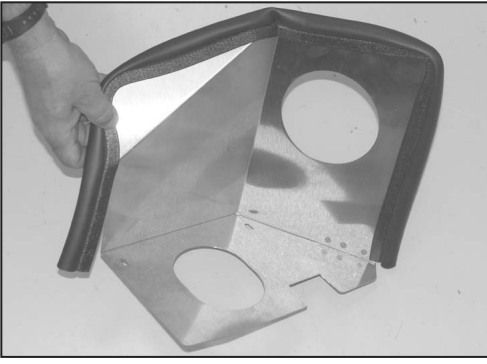

12. Install the provided edge trim onto the heat shield as shown.

NOTE: Some trimming of the edge trim may be necessary.

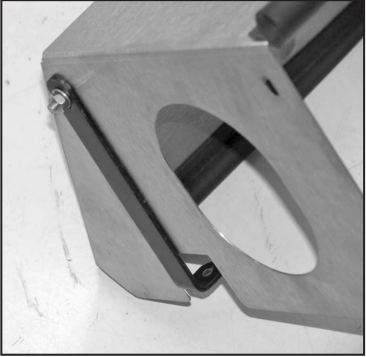

13. Install the provided "L" bracket #070026 onto the heat shield with the provided hardware as shown.

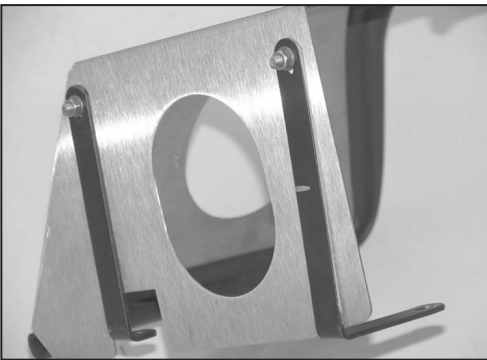

14. Install the provided "L" bracket #010054 onto the heat shield with the provided hardware as shown.



15. Install the heat shield assembly into the vehicle as shown. Secure the rear heat shield mounting bracket to the fresh air duct with the bolt removed in step #11. Secure the forward heat shield mounting bracket to the inner fender with the provided hardware as shown.



16. Install the heat shield mounting bracket #070840 onto the heat shield so that the other end of the bracket rests on the mounting tab on the strut tower as shown.

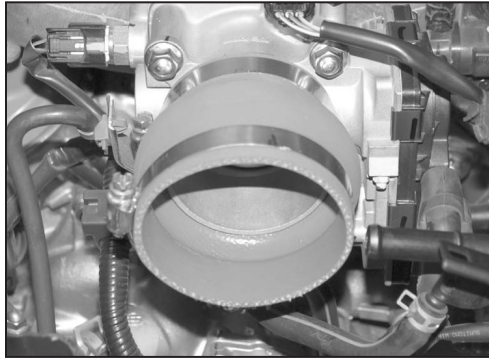

17. Install the silicone hose #08421 onto the throttle body with the provided hardware as shown.

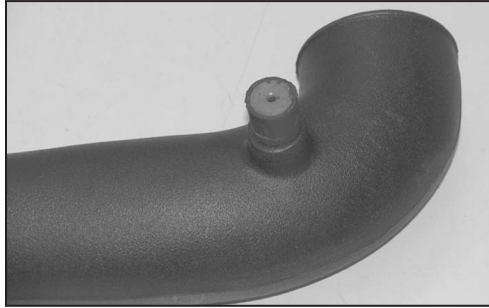

18. Install the provided rubber mounted stud onto the K&N® intake tube as shown.

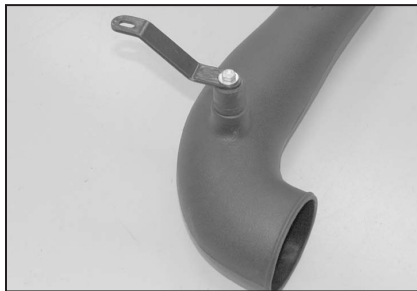

19. Install the tube mount bracket # 070065 onto the K&N® intake tube as shown.



20. Set the K&N® intake tube in place through the heat shield but not onto the throttle body as shown.



21. Install the air filter onto the K&N® intake tube and secure with the provided hose clamp.



22. Install the K&N® intake tube into the silicone hose at the throttle body and align the mounting bracket with the heat shield bracket and mounting tab on the strut tower. Tighten the hose clamp and secure the bracket to the heat shield bracket and mounting tab on the strut tower with the provided hardware.



23. Install the provided silicone vent hose onto the K&N® intake tube and then install the crankcase vent tube into the silicone hose as shown.



24. Reinstall the engine cover and secure in place with the three 1/4 turn fasteners.



25. Reconnect the vehicle's negative battery cable. Double check to make sure everything is tight and properly positioned before starting the vehicle.

26. The C.A.R.B. exemption sticker, (attached), must be visible under the hood so that an emissions inspector can see it when the vehicle is required to be tested for emissions. California requires testing every two years, other states may vary.

27. It will be necessary for all K&N® high flow intake systems to be checked periodically for realignment, clearance and tightening of all connections. Failure to follow the above instructions or proper maintenance may void warranty.

ROAD TESTING:

1. Start the engine with the transmission in neutral or park, and the parking brake engaged. Listen for air leaks or odd noises. For air leaks secure hoses and connections. For odd noises, find cause and repair before proceeding. This kit will function identically to the factory system except for being louder and much more responsive.

2. Test drive the vehicle. Listen for odd noises or rattles and fix as necessary.

3. If road test is fine, you can now enjoy the added power and performance from your kit.

4. K&N Engineering, Inc., suggests checking the air filter element periodically for excessive dirt build-up. When the element becomes covered in dirt (or once a year), service it according to the instructions on the Recharger® service kit, part number 99-5050 or 99-5000.

INTAKE SYSTEMS FOR VEHICLES LISTED ARE 50 STATE LEGAL. SEE KNFILTERS.COM FOR CARB STATUS ON EACH PART FOR A SPECIFIC VEHICLE.

* FREE K&N® decal To register your warranty, please see us online at knfilters.com/register. FREE K&N® decal *