



INTAKE SYSTEMS FOR VEHICLES LISTED ARE 50 STATE LEGAL. SEE KNFILTERS.COM FOR CARB STATUS ON EACH PART FOR A SPECIFIC VEHICLE.

# INSTALLATION INSTRUCTIONS

**57-3078**  
**CHEVROLET**  
**2012-14 Camaro**  
**V6-3.6L**

**TOOLS NEEDED:**

- 10mm Socket
- 13mm Socket
- 3mm Allen Wrench
- 4mm Allen Wrench
- Extension
- Flat Blade Screwdriver
- Ratchet

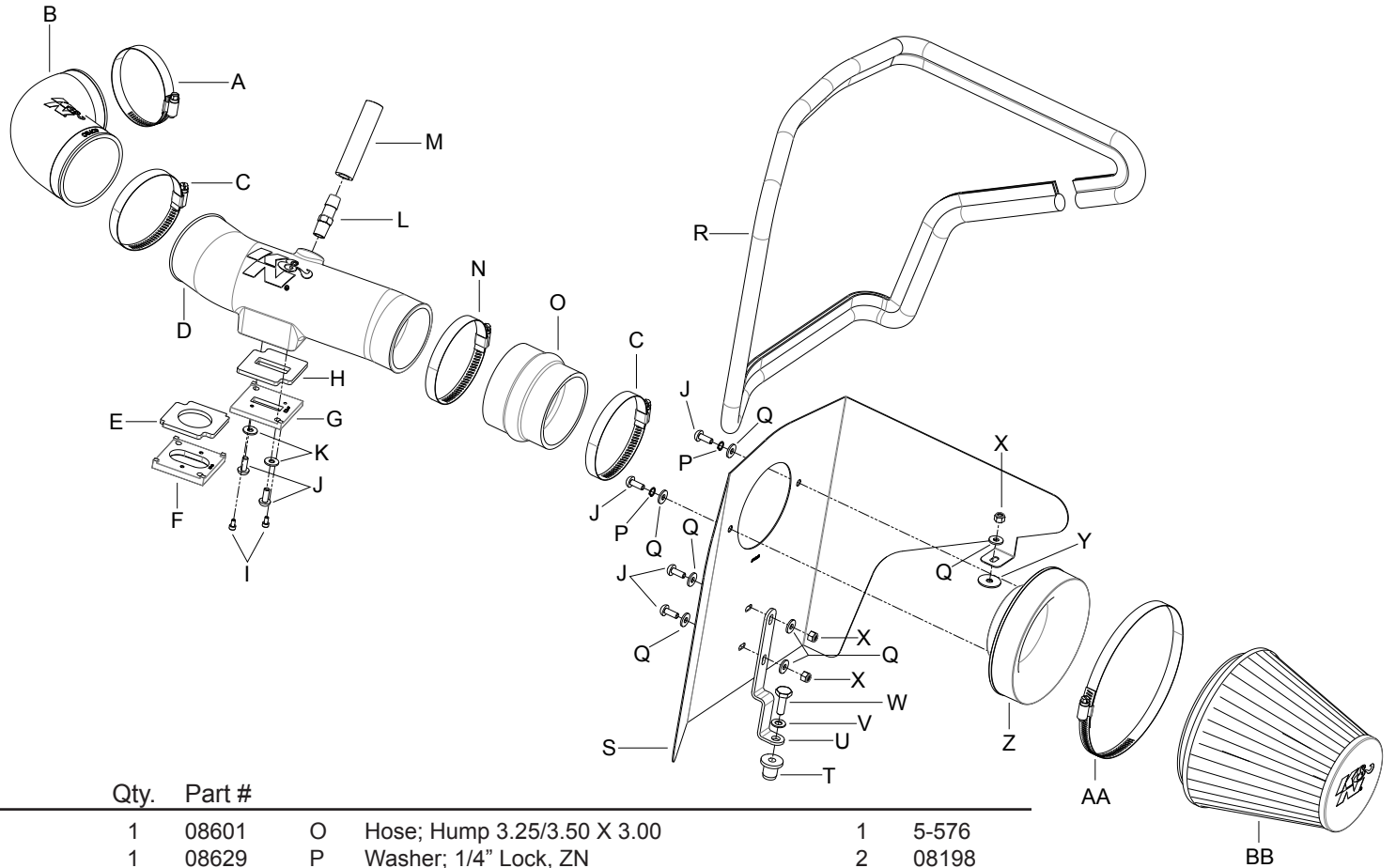

**PARTS LIST:**

Description	Qty.	Part #	Description	Qty.	Part #
A Hose Clamp #48	1	08601	O Hose; Hump 3.25/3.50 X 3.00	1	5-576
B Hose; 3-1/4" To 3" ID 90 DEG	1	08629	P Washer; 1/4" Lock, ZN	2	08198
C Hose Clamp #56	2	08620	Q Washer; 1/4"ID X 5/8"OD-SAE	7	08275
D Intake Tube	1	087256	R Edge Trim (70")	1	102454
E Gasket; 3/16 Poron	1	09074	S Heat Shield	1	074053
F Adapter; Mass Air Sensor	1	09404	T Insert; 5/16-18 X .600 OD X .730L Rubber	1	088002
G Adaptor; Nylon 6/6 GF, Black	1	21515	U Bracket; "Z" , STL, TK/PC	1	083126
H Gasket; 3/16 Poron	1	09069	V Washer; 5/16" ID X 5/8" OD, Flat	1	08276
I Bolt; M4-0.07 8mm, A/H Cap, SS	2	07733	W Bolt; 5/16"-18 X 1" L, SS	1	07777
J Bolt; M6 X 1.00 X 116mm, ButtnHd, SS	6	07730	X Nut; 6mm Nylock, Hexhead	3	07553
K Washer; 6mm Flat, SS	2	08269	Y Washer; 1" X .300 X 1.00 Rubber	1	21685
L Vent; STRT 1/2" Hose, 1/4" NPT, Plas.	1	080022	Z Adapter; Universal, 6" Filter 3.5" Coupler	1	21512-1
M Hose; 1/2" ID X 3-1/2"L	1	087028	AA Hose Clamp #104	1	08697
N Hose Clamp #52	1	08610	BB Air Filter	1	RC-5107

**NOTE: FAILURE TO FOLLOW INSTALLATION INSTRUCTIONS AND NOT USING THE PROVIDED HARDWARE MAY DAMAGE THE INTAKE TUBE, THROTTLE BODY AND ENGINE.**

**TO START:**

1. Turn off the ignition and disconnect the negative battery cable.  
**NOTE: Disconnecting the negative battery cable erases pre-programmed electronic memories. Write down all memory settings before disconnecting the negative battery cable. Some radios will require an anti-theft code to be entered after the battery is reconnected. The anti-theft code is typically supplied with your owner's manual. In the event your vehicles' anti-theft code cannot be recovered, contact an authorized dealership to obtain your vehicles anti-theft code.**



2. Remove the oil fill cap, lift up and remove the engine cover. Reinstall the oil cap.



3. Slide the red locking tab back and then disconnect the mass air sensor electrical connection.

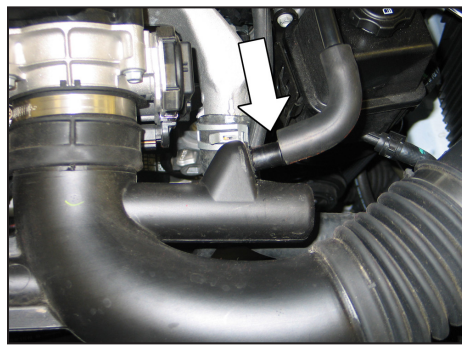

4. Disconnect the crank case vent hose from stock intake tube.

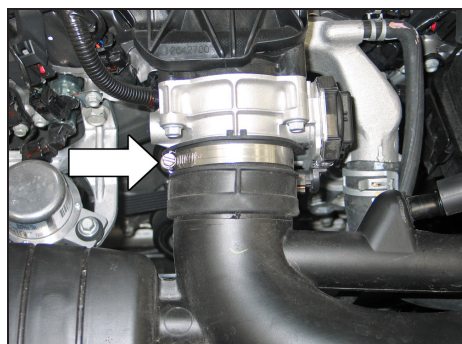

5. Loosen the hose clamp that secures the intake hose to the throttle body.

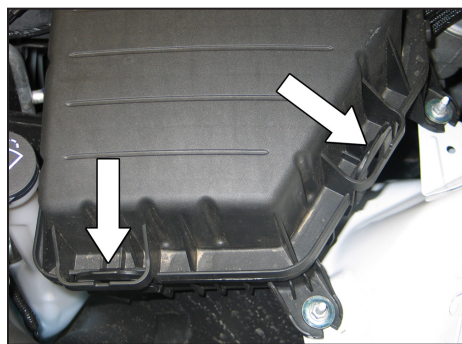

6. Unlatch the upper air box clips and remove the upper air box and intake tube assembly.



7. Remove the lower air box mounting nuts, then remove the lower air box assembly.  
**NOTE: K&N Engineering, Inc., recommends that customers do not discard factory air intake.**

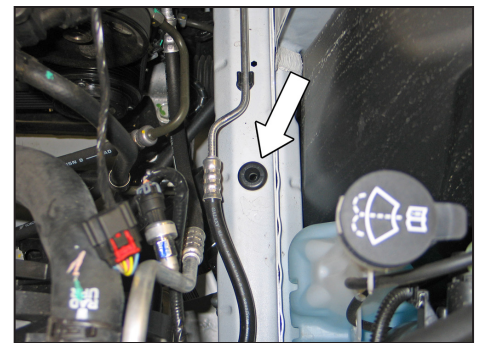

8. Remove the air box mounting grommet shown on the frame rail.

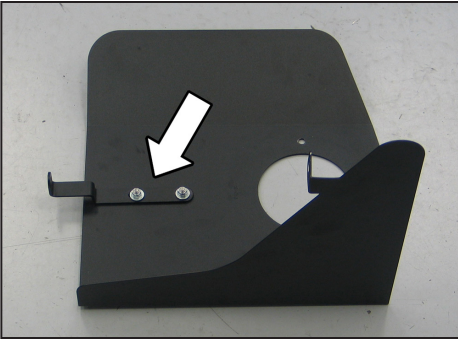

9. Install the heat shield mounting bracket (083126) onto the heat shield and secure with the provided hardware.

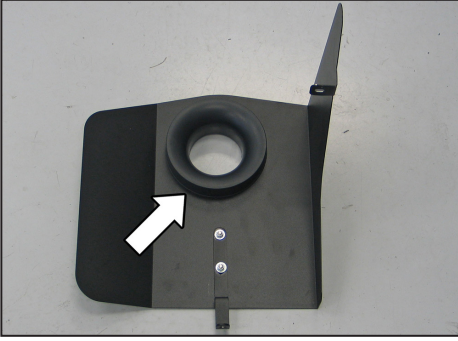

10. Install the filter adapter into the heat shield and secure with the provided hardware.

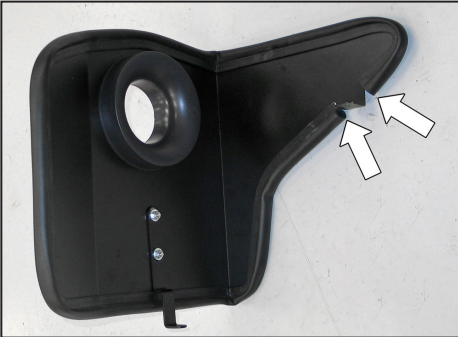

11. Install the provided edge trim onto the heat shield as shown.  
**NOTE: Some trimming of the edge trim will be necessary.**

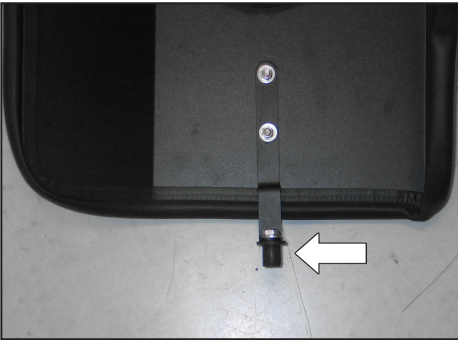

12. Install the provided inserted nut onto the heat shield mounting bracket and secure with the provided hardware.  
**NOTE: Do not completely tighten at this time.**



13. Install the provided rubber fender washer onto the outer air box mounting stud.

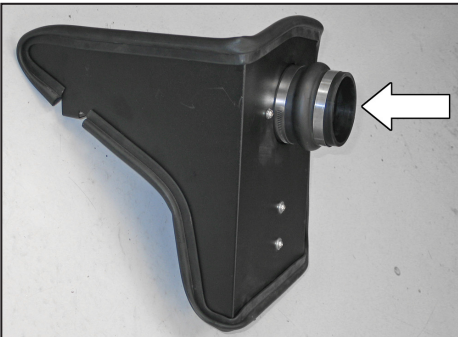

14. Install the provided silicone hose (5-576) onto the filter adapter as shown and secure with the provided hose clamp.

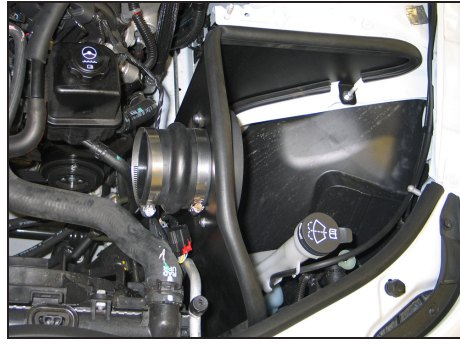

15. Install the heat shield assembly into the vehicle so the inserted nut goes into the air box mounting grommet hole and the tab goes onto the air box mounting stud. Secure the heat shield with the provided hardware.

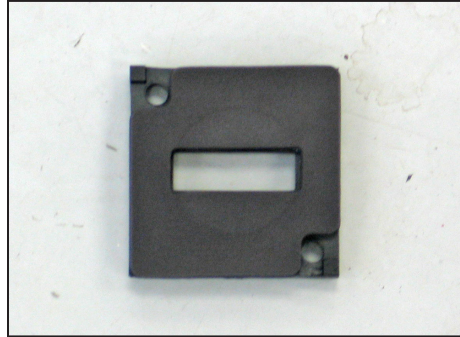
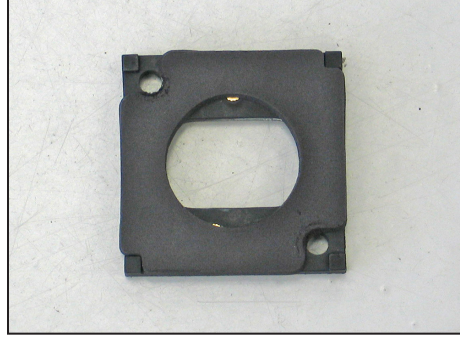

16. Install the provided gasket onto the mass air sensor adapter.  
**NOTE: Vehicle's MAF sensor may vary among model years, use appropriate gasket and mass air sensor adapter.**

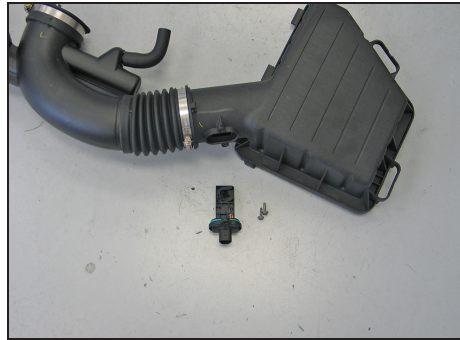

17. Remove the two screws that secure the mass air sensor into the factory intake tube.  
**NOTE: Vehicle's MAF sensor may vary among model years, reference appropriate image above.**

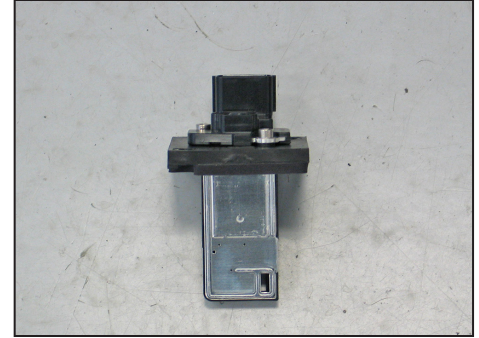
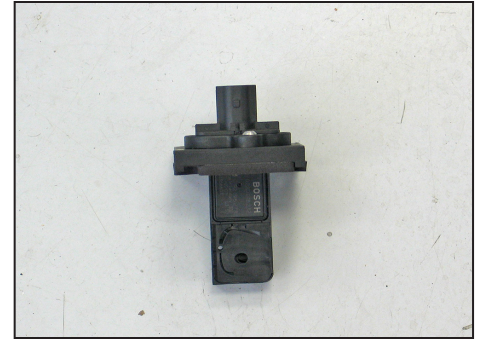

18. Install the mass air sensor into the mass air sensor adapter and secure with the provided hardware.  
**NOTE: Vehicle's MAF sensor may vary among model years, reference appropriate image above.**

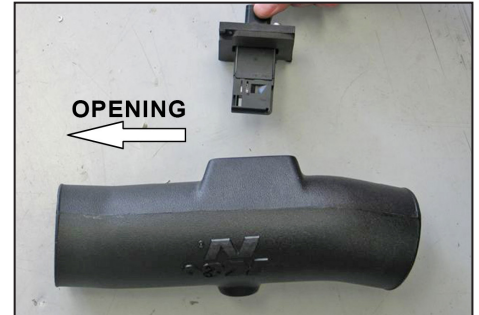

19. Install the mass air sensor assembly into the K&N® intake tube as shown and secure with the provided hardware.  
**NOTE: The opening of the mass air sensor is to be pointed towards the inlet side of the tube as shown in photo.**  
**NOTE: Vehicle's MAF sensor may vary among model years, reference appropriate image above.**

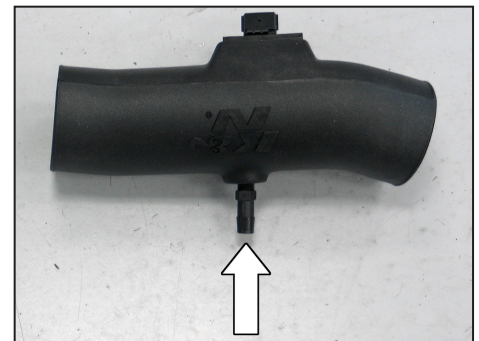

20. Install the provided vent fitting into the K&N® intake tube as shown.  
**NOTE: Plastic NPT fittings are easy to cross thread. Install the vent fitting "hand" tight, then turn it two complete turns with a wrench.**



21. Install the provided silicone hose (08629) onto the K&N® intake tube as shown. Install the K&N® intake tube assembly onto the throttle body and hump hose attached to the filter adapter. Adjust the intake tube in the hoses for proper fit, once proper fit is achieved secure the tube with the provided hose clamps.



22. Remove the 90° vent hose from the crank case vent tube. Install the provided silicone vent hose and install it onto the fitting installed into the K&N® intake tube. Trim the vent hose for proper fit.



23. Install the K&N® air filter and secure with the provided hose clamp.

**NOTE: Drycharger® air filter wrap; part # RC-5107DK is available to purchase separately. To learn more about Drycharger® filter wraps or look up color availability please visit <http://www.knfilters.com>®.**



24. Reconnect the mass air sensor electrical connection.



25. Reinstall the engine cover.



26. Reconnect the vehicle's negative battery cable. Double check to make sure everything is tight and properly positioned before starting the vehicle.

27. The C.A.R.B. exemption sticker, (attached), must be visible under the hood so that an emissions inspector can see it when the vehicle is required to be tested for emissions. California requires testing every two years, other states may vary.

28. It will be necessary for all K&N® high flow intake systems to be checked periodically for realignment, clearance and tightening of all connections. Failure to follow the above instructions or proper maintenance may void warranty.

#### ROAD TESTING:

1. Start the engine with the transmission in neutral or park, and the parking brake engaged. Listen for air leaks or odd noises. For air leaks secure hoses and connections. For odd noises, find cause and repair before proceeding. This kit will function identically to the factory system except for being louder and much more responsive.

2. Test drive the vehicle. Listen for odd noises or rattles and fix as necessary.

3. If road test is fine, you can now enjoy the added power and performance from your kit.

4. K&N Engineering, Inc., requires cleaning the intake system's air filter element every 100,000 miles. When used in dusty or off-road environments, our filters will require cleaning more often. We recommend that you visually inspect your filter once every 25,000 miles to determine if the screen is still visible. When the screen is no longer visible some place on the filter element, it is time to clean it. To clean and re-oil, purchase our filter Recharger® service kit, part number 99-5050 or 99-5000 and follow the easy instructions.

**INTAKE SYSTEMS FOR VEHICLES LISTED ARE 50 STATE LEGAL. SEE KNFILTERS.COM FOR CARB STATUS ON EACH PART FOR A SPECIFIC VEHICLE.**