



INTAKE SYSTEMS FOR VEHICLES LISTED ARE 50 STATE LEGAL. SEE KNFILTERS.COM FOR CARB STATUS ON EACH PART FOR A SPECIFIC VEHICLE.

# INSTALLATION INSTRUCTIONS

**57-1535**  
**DODGE**  
**2003-05 Neon SRT-4**  
**L4-2.4L Turbo**

**PARTS LIST:**

Description	Qty.	Part #
A	2	08560
B	1	08284
C	1	087100
D	1	08462
E	1	08376
F	1	078855
G	1	08180
H	1	07182
I	11	08275
J	8	07553
K	1	08577
L	1	08407
M	1	074012
N	1	102466
O	1	102480
P	5	07703
Q	2	07730
R	2	070952
S	1	070066
T	1	071001
U	1	08064
V	1	08648
W	1	21561
X	1	RP-4660

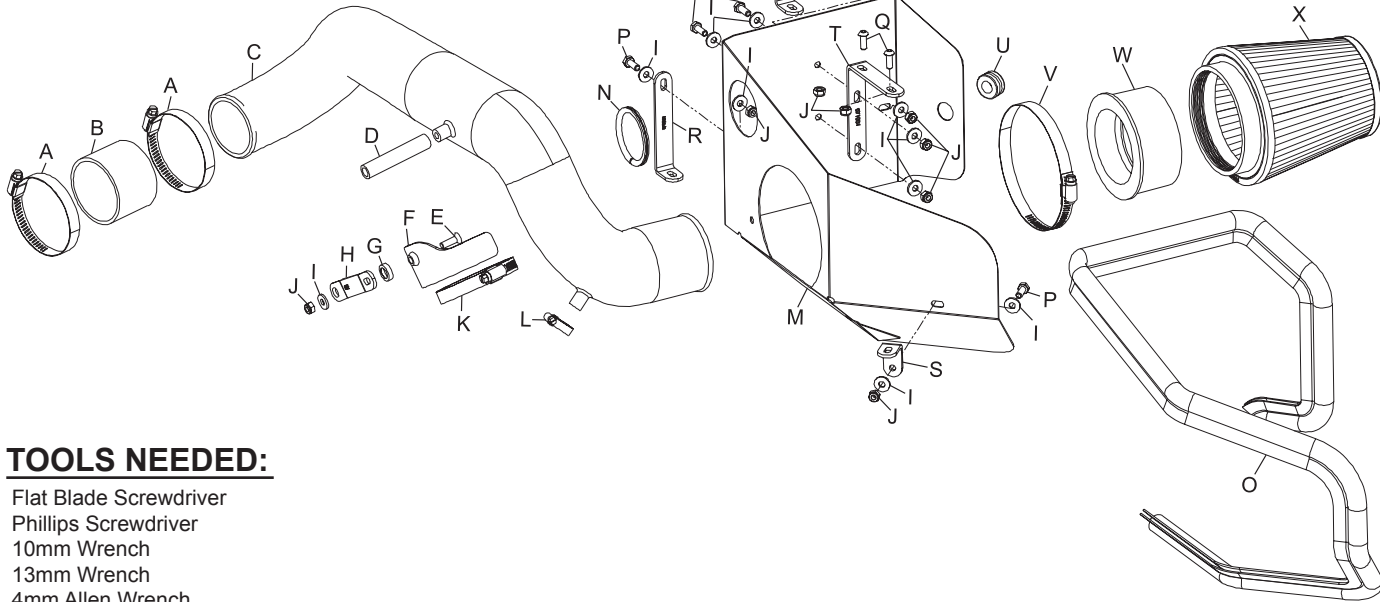

**TOOLS NEEDED:**

- Flat Blade Screwdriver
- Phillips Screwdriver
- 10mm Wrench
- 13mm Wrench
- 4mm Allen Wrench
- Ratchet
- Extension
- 8mm Socket
- 10mm Socket

**NOTE: FAILURE TO FOLLOW INSTALLATION INSTRUCTIONS AND NOT USING THE PROVIDED HARDWARE MAY DAMAGE THE INTAKE TUBE, THROTTLE BODY AND ENGINE.**

**TO START:**

1. Turn off the ignition and disconnect the negative battery cable.  
**NOTE: Disconnecting the negative battery cable erases pre-programmed electronic memories. Write down all memory settings before disconnecting the negative battery cable. Some radios will require an anti-theft code to be entered after the battery is reconnected. The anti-theft code is typically supplied with your owner's manual. In the event your vehicles' anti-theft code cannot be recovered, contact an authorized dealership to obtain your vehicles anti-theft code.**

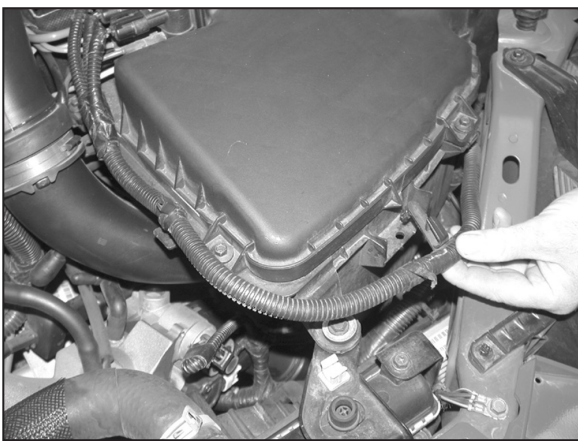

2. Release the two clips that secure the wiring harness to air box as shown.



3. Disconnect the three electrical connectors from solenoid pack as shown.



4. Remove the two screws that secure the solenoid pack to air box lid, then disconnect vacuum lines from solenoid pack as shown.



5. Remove the five 8mm bolts that secure the air box lid to air box, then remove lid and air filter as shown.

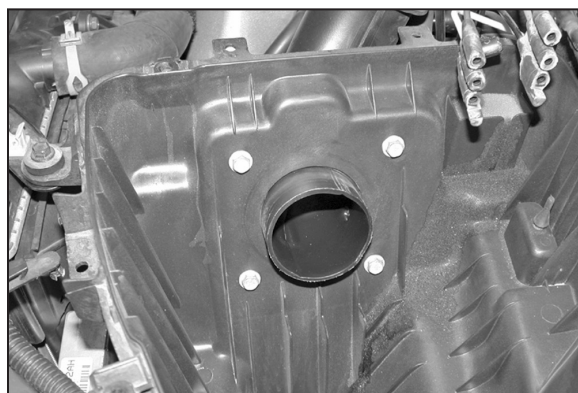

6. Remove the four 10mm bolt that secure the intake tube to air box.



7. Disconnect the air temp sensor electrical connection as shown.

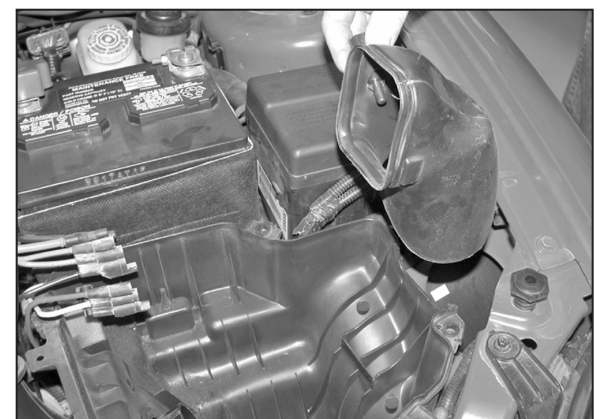

8. Remove the fresh air intake tube from vehicle as shown.

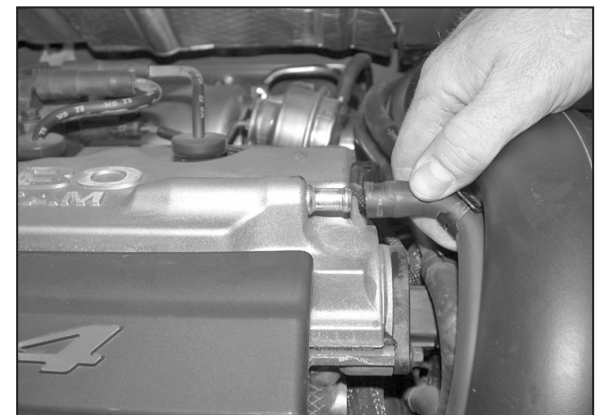

9. Disconnect the crank case vent from valve cover as shown.

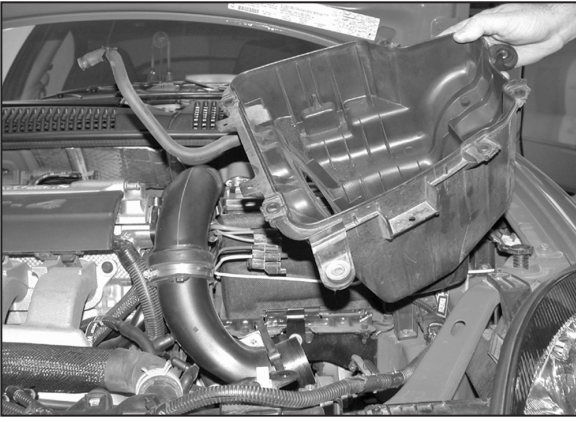

10. Remove the two 10mm bolts that secure the air box to vehicle, then remove air box from vehicle as shown.

**NOTE: K&N Engineering, Inc., recommends that customers do not discard factory air intake.**

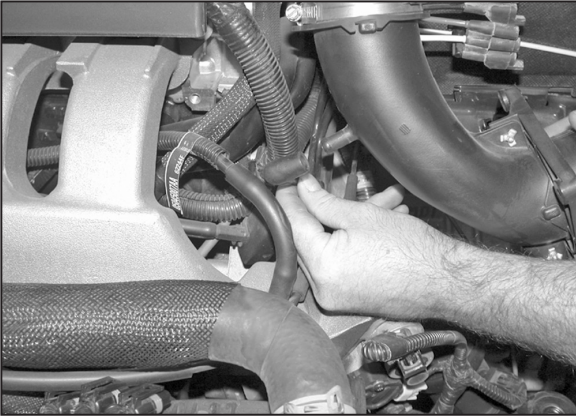

11. Remove the intake vent line from intake tube as shown.



12. Loosen the hose clamp at the turbo, then remove the intake tube as shown.

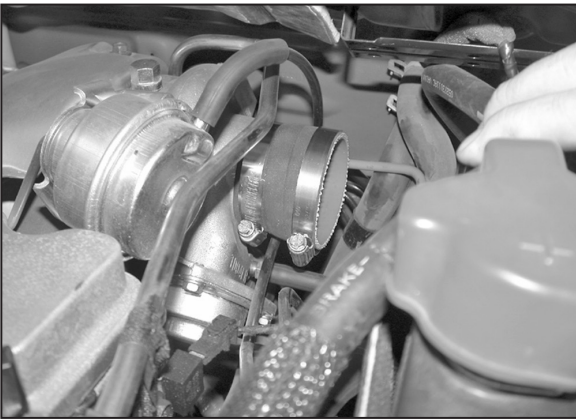

13. Install the provided silicone hose (08284) onto the turbo with the provided hose clamp.



14. Assemble the saddle bracket assembly as shown.

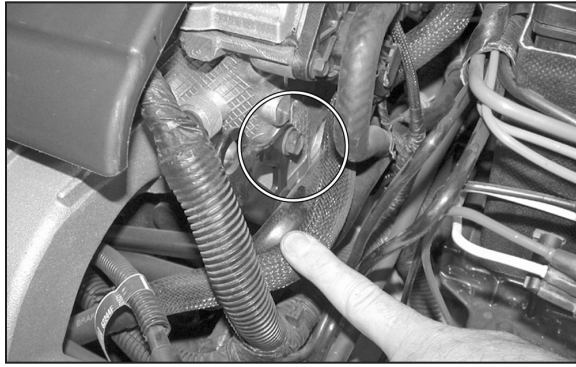

15. Remove the 13mm bolt that secures the engine removal bracket to engine as shown.



16. Using the bolt that was removed in the previous step, secure saddle bracket assembly onto engine as shown.

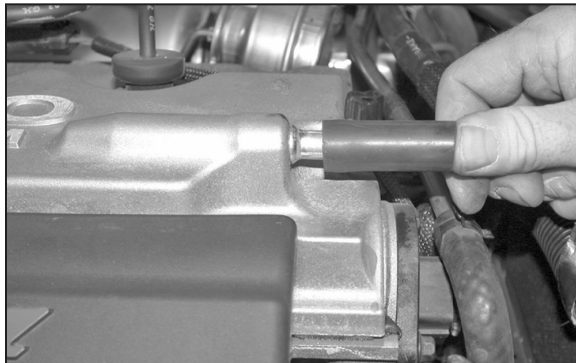

17. Install the provided silicone hose onto the valve cover as shown.

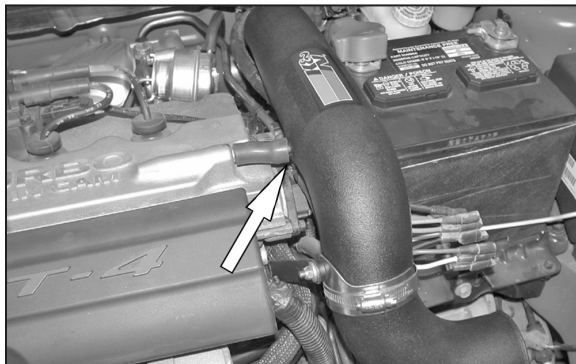

18. Install the K&N® intake tube onto the turbo, then align with saddle bracket. Then tighten all hose clamps.  
**NOTE: Connect the crank case vent line onto intake tube.**

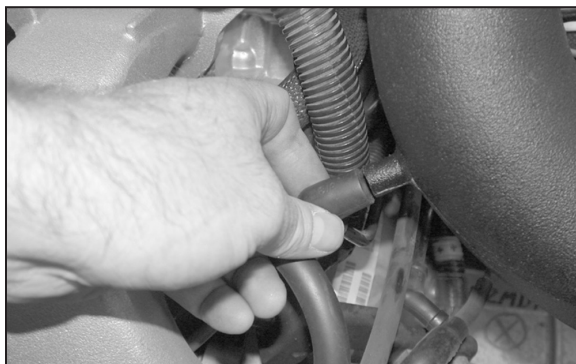

19. Reconnect the intake vent line onto the intake tube, then secure with provided hose clamp.

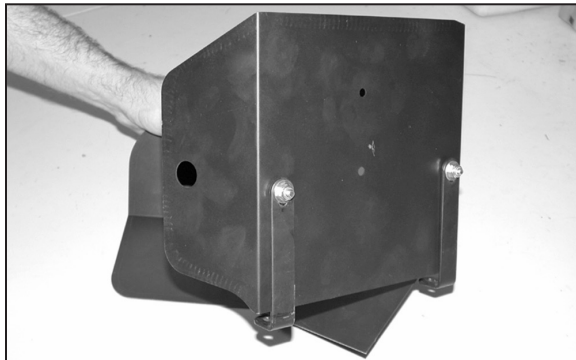

20. Install the provided brackets (070952) onto heat shield with the provided hardware as shown. Do not tighten completely.

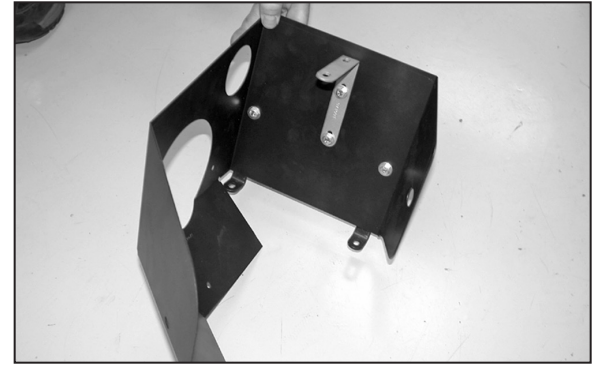

21. Install the provided bracket (071001) onto heat shield with the provided hardware as shown.  
**NOTE: The holes that are off set, do not mount to heat shield.**

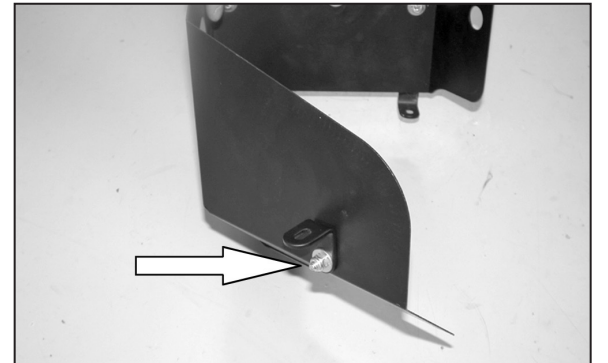

22. Install the provided bracket (070066) onto heat shield with the provided hardware as shown. Do not tighten completely.

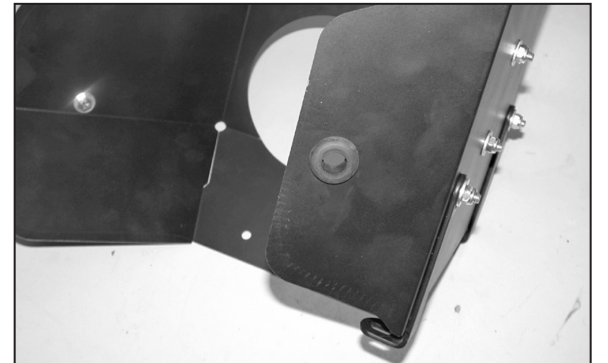

23. Install the provided grommet onto the heat shield as shown.



24. Install the edge trim onto the heat shield as shown. Trim if needed.



25. Install the edge seal onto heat shield as shown.

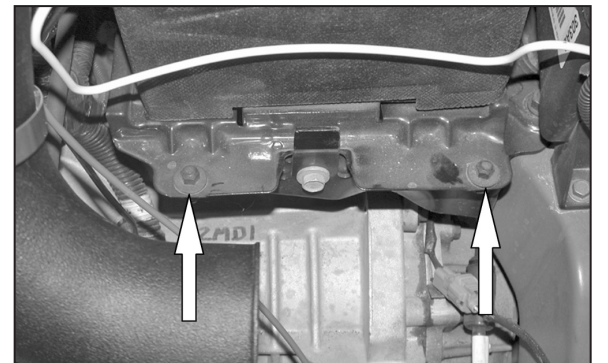

26. Remove the two 10mm bolts from battery tray as shown.



27. Install the heat shield onto vehicle, then secure heat shield to the vehicle with the factory bolts that were removed.

**NOTE: Run the vacuum lines and electrical connections for solenoid through hole in heat shield. Connect wiring harness onto holes in heat shield**

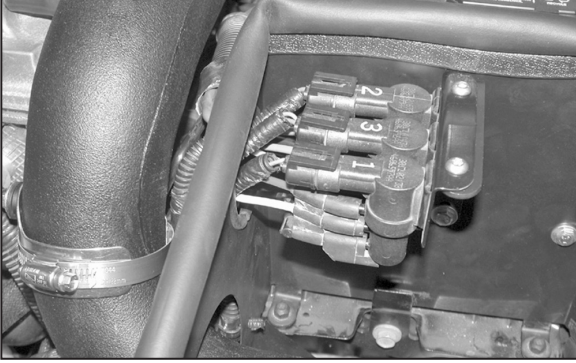

28. Connect the solenoid pack onto heat shield with the provided hardware, then reconnect the vacuum lines and electrical connections onto solenoid as shown.

**NOTE: Make sure all connections match up with their color codes.**



29. Remove temp sensor from fresh air intake as shown.

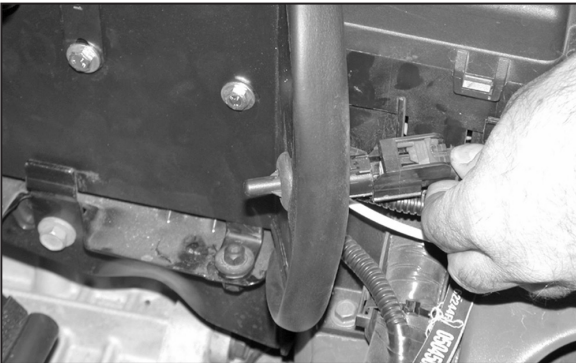

30. Install temp sensor into heat shield then reconnect the electrical connection as shown.



31. Install the filter adapter onto the new K&N® intake tube as shown.

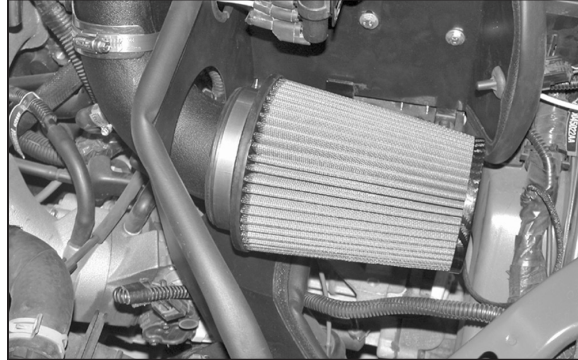

32. Install the K&N® filter charger onto the filter adapter as shown.

**NOTE: Drycharger® air filter wrap; part # RP-4660DK is available to purchase separately. To learn more about Drycharger® filter wraps or look up color availability please visit <http://www.knfilters.com>®.**



33. Reconnect the vehicle's negative battery cable. Double check to make sure everything is tight and properly positioned before starting the vehicle.

34. The C.A.R.B. exemption sticker, (attached), must be visible under the hood so that an emissions inspector can see it when the vehicle is required to be tested for emissions. California requires testing every two years, other states may vary.

35. It will be necessary for all K&N® high flow intake systems to be checked periodically for realignment, clearance and tightening of all connections. Failure to follow the above instructions or proper maintenance may void warranty.

#### ROAD TESTING:

1. Start the engine with the transmission in neutral or park, and the parking brake engaged. Listen for air leaks or odd noises. For air leaks secure hoses and connections. For odd noises, find cause and repair before proceeding. This kit will function identically to the factory system except for being louder and much more responsive.

2. Test drive the vehicle. Listen for odd noises or rattles and fix as necessary.

3. If road test is fine, you can now enjoy the added power and performance from your kit.

4. K&N Engineering, Inc., requires cleaning the intake system's air filter element every 100,000 miles. When used in dusty or off-road environments, our filters will require cleaning more often. We recommend that you visually inspect your filter once every 25,000 miles to determine if the screen is still visible. When the screen is no longer visible some place on the filter element, it is time to clean it. To clean and re-oil, purchase our filter Recharger® service kit, part number 99-5050 or 99-5000 and follow the easy instructions.

**INTAKE SYSTEMS FOR VEHICLES LISTED ARE 50 STATE LEGAL. SEE KNFILTERS.COM FOR CARB STATUS ON EACH PART FOR A SPECIFIC VEHICLE.**