



INTAKE SYSTEMS FOR VEHICLES LISTED ARE 50 STATE LEGAL. SEE KNFILTERS.COM FOR CARB STATUS ON EACH PART FOR A SPECIFIC VEHICLE.

INSTALLATION INSTRUCTIONS

57-1528
JEEP
2002-03 Liberty
V6-3.7L

NOTE: This kit was not designed to fit vehicles with a body lift.

TOOLS NEEDED:

- Flat Blade Screw Driver
- 5mm Alien Wrench
- Ratchet
- 10mm Socket
- 13mm Socket
- Med. Extension

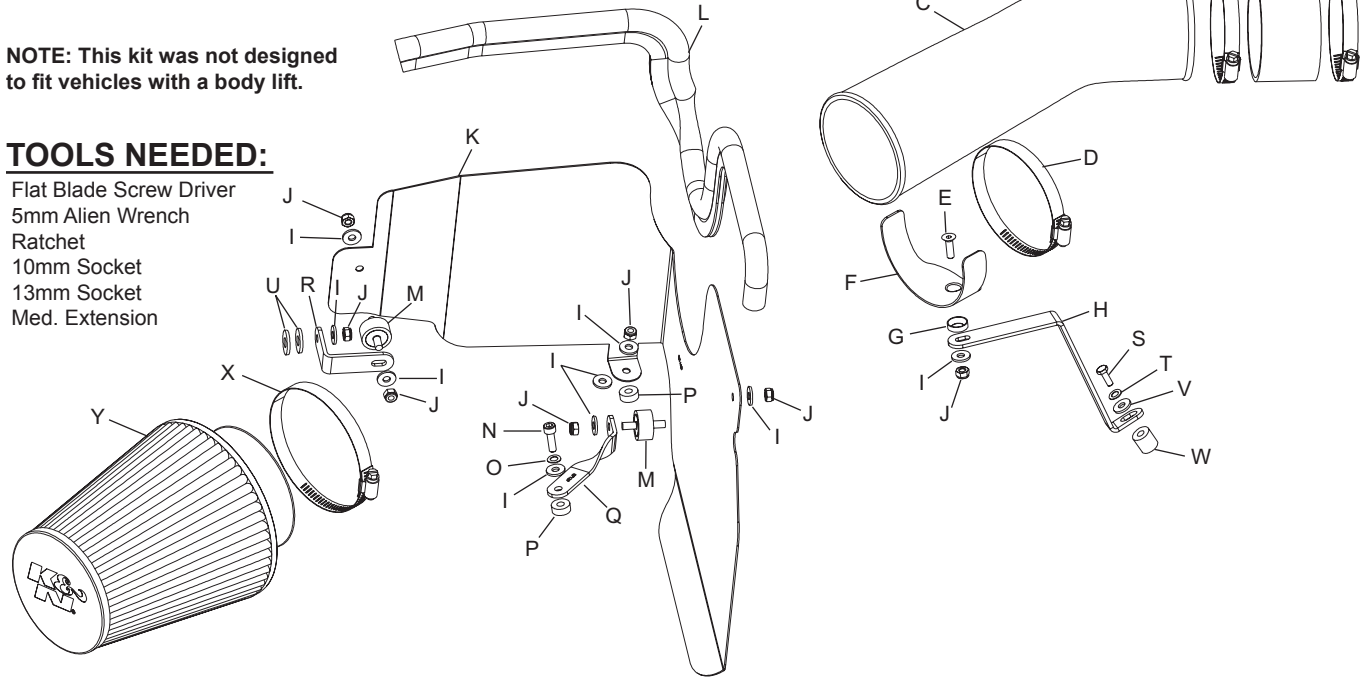

PARTS LIST:

Description	Qty.	Part #
A	2	08601
B	1	08690
C	1	087055
D	1	08620
E	1	08376
F	1	078855
G	1	08180
H	1	07140
I	8	08275
J	7	07553
K	1	07469
L	1	102489
M	2	07027
N	1	07852
O	1	08174
P	2	06555
Q	1	07139
R	1	070932
S	1	07745
T	1	08239
U	2	08160
V	1	08276
W	1	06547
X	1	08648
Y	1	RC-5060

NOTE: FAILURE TO FOLLOW INSTALLATION INSTRUCTIONS AND NOT USING THE PROVIDED HARDWARE MAY DAMAGE THE INTAKE TUBE, THROTTLE BODY AND ENGINE.

TO START:

1. Turn off the ignition and disconnect the negative battery cable.
NOTE: Disconnecting the negative battery cable erases pre-programmed electronic memories. Write down all memory settings before disconnecting the negative battery cable. Some radios will require an anti-theft code to be entered after the battery is reconnected. The anti-theft code is typically supplied with your owner's manual. In the event your vehicles' anti-theft code cannot be recovered, contact an authorized dealership to obtain your vehicles anti-theft code.



2. Loosen hose clamp at intake resonator and remove hose.



3. Firmly lift up to disengage air box from retaining grommets and remove air box from vehicle.
NOTE: K&N Engineering, Inc., recommends that customers do not discard factory air intake.

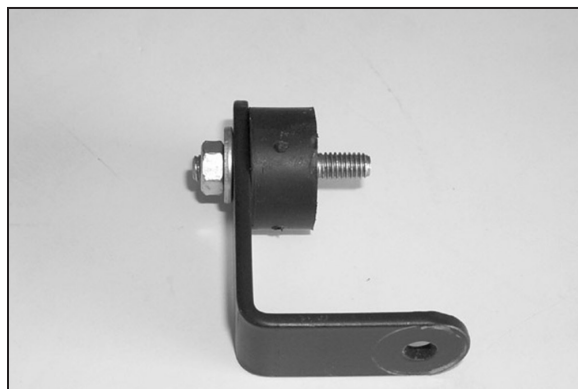

4. Assemble "L" bracket and rubber mounted stud as shown.

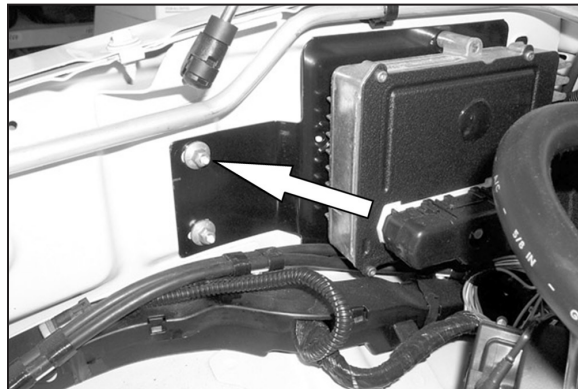

5. Remove nut from inner fender on vehicles that come equipped with a TCM.



5a. Secure "L" bracket to inner fender with the nut that was removed in the previous step.



6. Mount "L" bracket onto existing stud with the provided hardware.
NOTE: Make sure to install two washers onto stud before mounting bracket.



7. Remove the 6mm bolt from core support.



8. Assemble the bracket and rubber mounted stud as shown.



9. Install the bracket onto core support with the provided allen bolt as shown.

NOTE: Make sure 1/4 spacer is placed under new bracket.



10. Install edge trim onto heat shield as shown. Trim if needed.

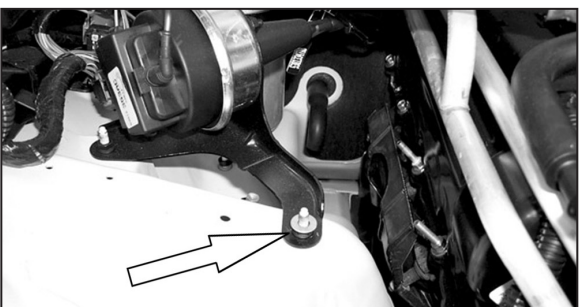

11. Install the provided 1/4 washer onto existing nut that retains the cruise control bracket to vehicle.



11a. Vehicles that do not come equipped with cruise control, install the provided spacer and washer onto the stud as shown.

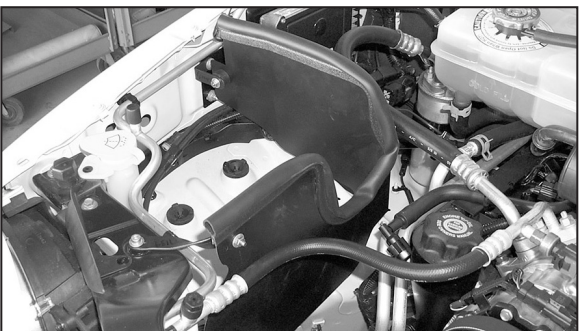

12. Install heat shield onto the vehicle with the provided hardware as shown.

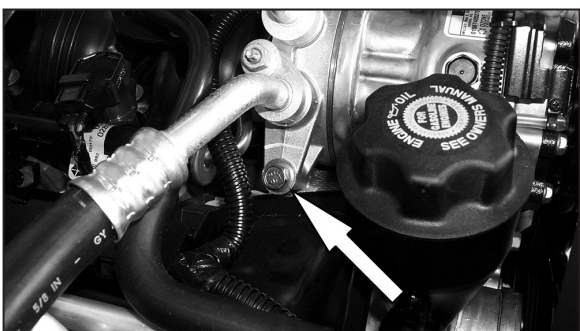

13. Remove the A/C compressor-mounting bolt.



14. Assemble the saddle bracket onto the "Z" bracket as shown.

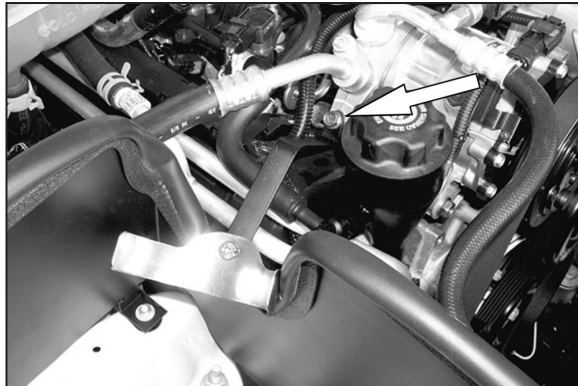

15. Install the "Z" bracket onto the A/C compressor and secure with the bolt that was removed in step 13.

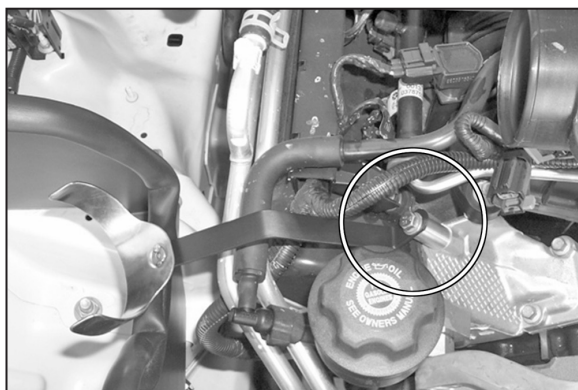

16. On vehicles that do not come equipped with A/C, mount the "Z" bracket onto the intake manifold with the provided hardware.

NOTE: Make sure to install the provided spacer behind the "Z" bracket as shown.



17. Install the provided silicone hose onto the resonator with the provided hose clamps as shown.



18. Install the new K&N intake tube onto the resonator, position the intake tube for proper clearance then tighten hose clamps at the resonator and saddle bracket.



19. Install the K&N Filtercharger onto the new K&N intake tube as shown.

NOTE: Drycharger air filter wrap; part # RC-5060DK is available to purchase separately. To learn more about Drycharger filter wraps or look up color availability please visit <http://www.knfilters.com>.



20. Reconnect the vehicle's negative battery cable. Double check to make sure everything is tight and properly positioned before starting the vehicle.

21. The C.A.R.B. exemption sticker, (attached), must be visible under the hood so that an emissions inspector can see it when the vehicle is required to be tested for emissions. California requires testing every two years, other states may vary.

22. It will be necessary for all K&N high flow intake systems to be checked periodically for realignment, clearance and tightening of all connections. Failure to follow the above instructions or proper maintenance may void warranty.

ROAD TESTING:

1. Start the engine with the transmission in neutral or park, and the parking brake engaged. Listen for air leaks or odd noises. For air leaks secure hoses and connections. For odd noises, find cause and repair before proceeding. This kit will function identically to the factory system except for being louder and much more responsive.

2. Test drive the vehicle. Listen for odd noises or rattles and fix as necessary.

3. If road test is fine, you can now enjoy the added power and performance from your kit.

4. K&N Engineering, Inc., requires cleaning the intake system's air filter element every 100,000 miles. When used in dusty or off-road environments, our filters will require cleaning more often. We recommend that you visually inspect your filter once every 25,000 miles to determine if the screen is still visible. When the screen is no longer visible some place on the filter element, it is time to clean it. To clean and re-oil, purchase our filter Recharger service kit, part number 99-5050 or 99-5000 and follow the easy instructions.

INTAKE SYSTEMS FOR VEHICLES LISTED ARE 50 STATE LEGAL. SEE KNFILTERS.COM FOR CARB STATUS ON EACH PART FOR A SPECIFIC VEHICLE.