

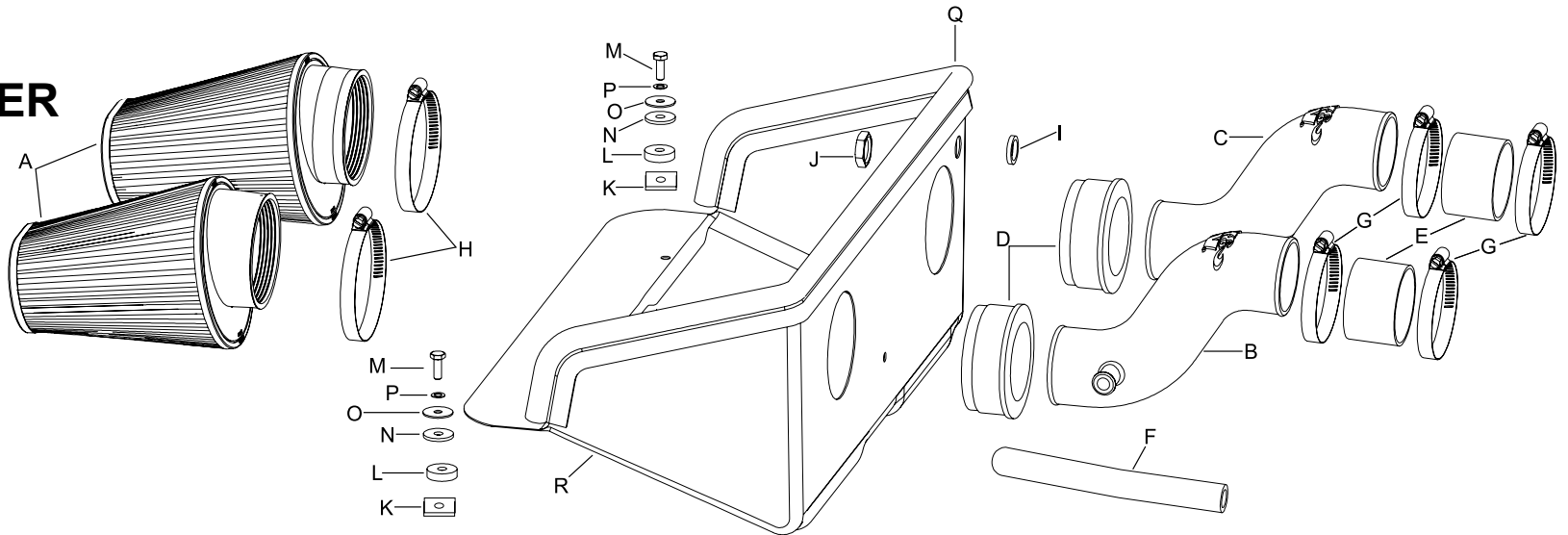

INTAKE SYSTEMS FOR VEHICLES LISTED ARE 50 STATE LEGAL. SEE KNFILTERS.COM FOR CARB STATUS ON EACH PART FOR A SPECIFIC VEHICLE.

INSTALLATION INSTRUCTIONS

57-1508
DODGE
1995-98 VIPER
V10-8.0L



TOOLS NEEDED:

- 7/16" Wrench
- 7/8" Wrench
- Flat Blade Screwdriver
- Pair of pliers
- Hacksaw
- Diegrinder w/cut off wheel
- Drill
- 1/4" Drill bit
- Razor Blade

PARTS LIST:

Description	Qty.	Part #	Description	Qty.	Part #	Description	Qty.	Part #	Description	Qty.	Part #
A Air Filter	2	RF-1033	F Hose; 5/8" ID X 13" L	1	08602	K Clip Nut	2	07564	P Wave Washer	2	08174
B Intake Tube (V)	1	08732	G Hose Clamp #40	4	08554	L Teflon Washer	2	08281	Q Trim Seal 44"L	1	102486
C Intake Tube (U)	1	08731	H Hose Clamp #56	2	08620	M Hex Bolt	2	08386	R Heat Shield	1	07407
D Adapter	2	21522-1	I Air Temp. Sensor Gasket	1	09767	N Rubber Washer	2	21685			
E Silicone Hose	2	08727	J NPT Nut	1	07526	O Fender Washer	2	08160			

NOTE: FAILURE TO FOLLOW INSTALLATION INSTRUCTIONS AND NOT USING THE PROVIDED HARDWARE MAY DAMAGE THE INTAKE TUBE, THROTTLE BODY AND ENGINE.

TO START:

1. Turn off the ignition and disconnect the negative battery cable.
NOTE: Disconnecting the negative battery cable erases pre-programmed electronic memories. Write down all memory settings before disconnecting the negative battery cable. Some radios will require an anti-theft code to be entered after the battery is reconnected. The anti-theft code is typically supplied with your owner's manual. In the event your vehicles' anti-theft code cannot be recovered, contact an authorized dealership to obtain your vehicles anti-theft code.



2. Loosen the three air box retaining screws, two in front and one in rear.



3. Detach the speed control hose from the air box.



4. Detach the crankcase vent hose from the air box.

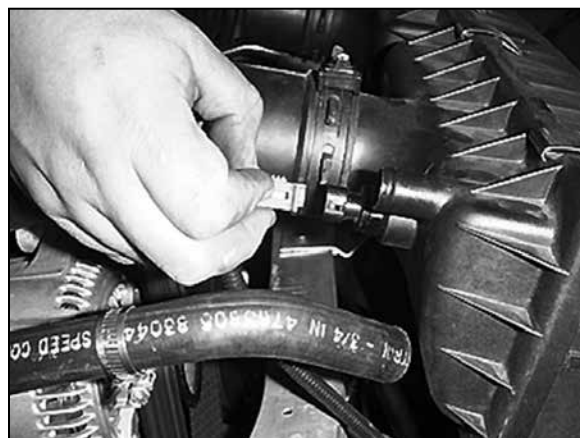

5. Disconnect the air temperature sensor electrical connection.



6. Disconnect the intake hoses from the throttle body.



7. Remove the air box assembly.
NOTE: K&N Engineering, Inc., recommends that customers do not discard factory air intake.



8. Loosen and remove the air temperature sensor from the air box.



9a. On models equipped with an aluminum crossmember, drill out the rivet that retains the rear air box mounting bracket. Remove the bracket as it will not be used.

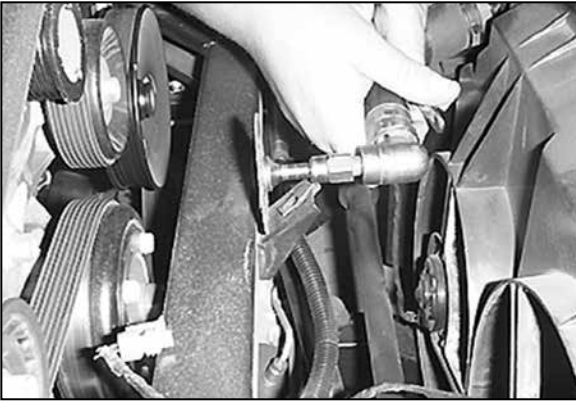

9b. On models equipped with a steel crossmember, move the wire harness away and cut off the rear air box mounting bracket.

NOTE: If diegrinder is not available, use a hacksaw.



10. Apply the air temperature sensor gasket to the heat shield.

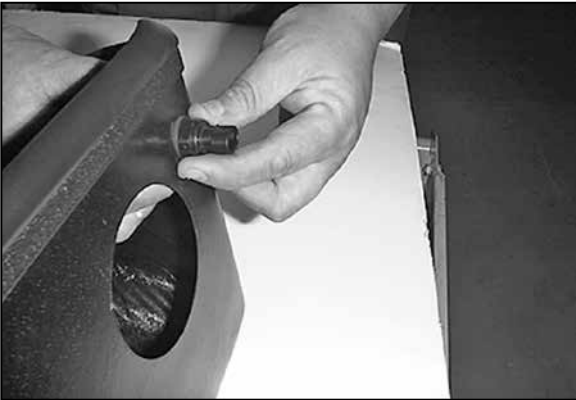

11. Install the air temperature sensor into the small hole in the heat shield and secure with the NPT nut provided.



12. Install the trim seal onto the heat shield.



13. Using a flat blade screwdriver, remove the two air box mounting studs from the radiator core support.

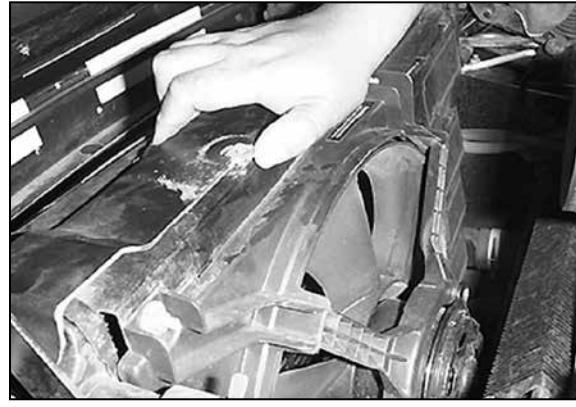

14. Install the two clip nuts provided onto the radiator core support as shown.

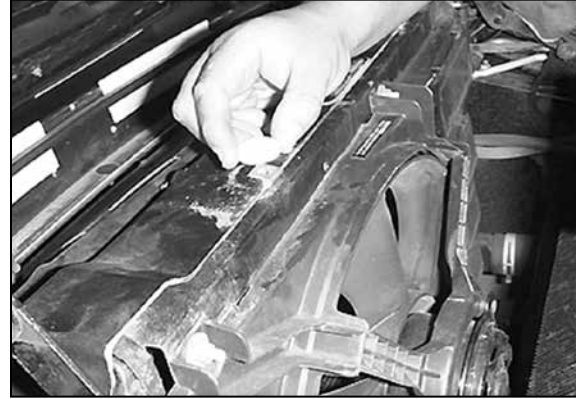

15. Place the teflon washers onto the clip nuts as shown.

NOTE: It may be helpful to use some scotch tape or sealing grease to help hold the washers in place during the installation of the heat shield.



16. Install the heat shield and secure it using the provided hardware.



17. Install the adapters onto the K&N® intake tubes.



18. Install the silicone hoses onto the K&N® intake tubes.



19. Slide the silicone hose down flush with the end of the intake tube.



20. Slide the adapter tube assembly into the hole in the heat shield.

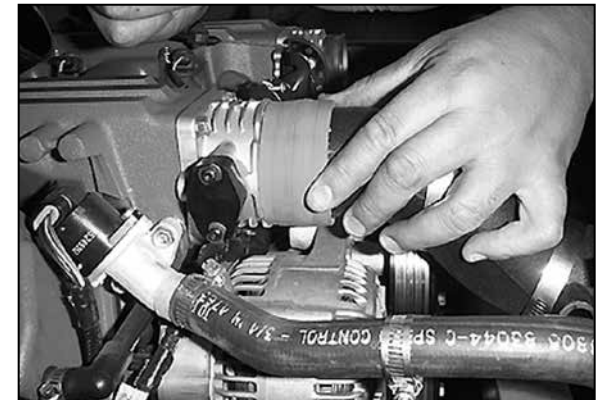

21. Slide the silicone hose onto the throttle body flange.

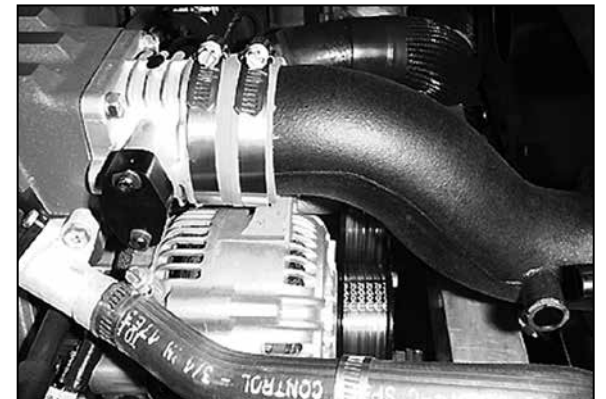

22. Secure the intake tube to the throttle body with the hose clamps.

23. Repeat the previous four steps to install the second intake tube.

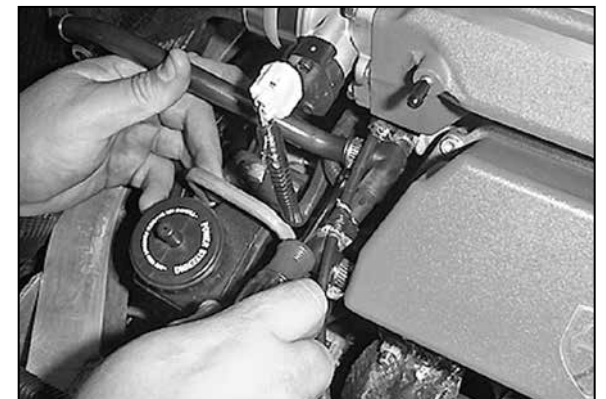

24. Remove the plastic crankcase vent tube assembly.
NOTE: Detach the vent hose from the vent tube as it will not be used.

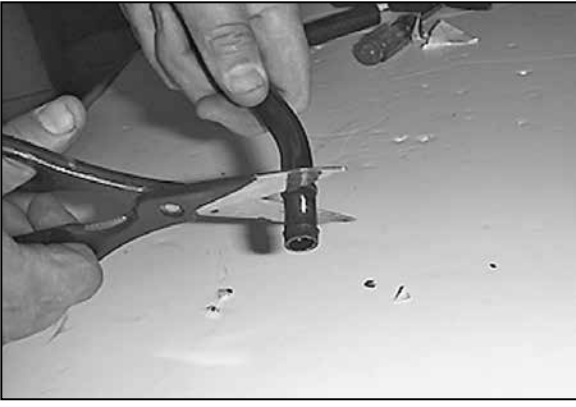

25. Cut the vent tube down to the second bead.

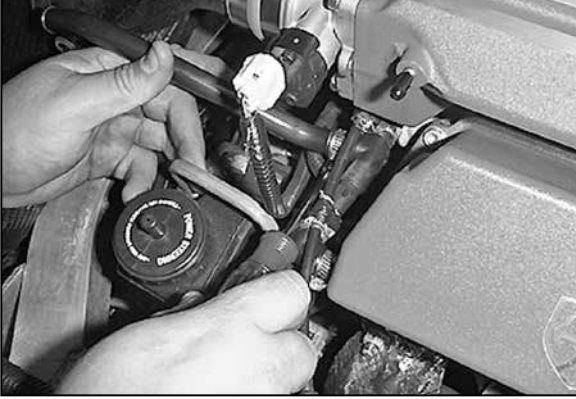

26. Reinstall the vent tube.



27. Using the vent hose provided, connect the vent tube to the vent on the intake tube.

NOTE: It will be necessary to cut the hose for best fit

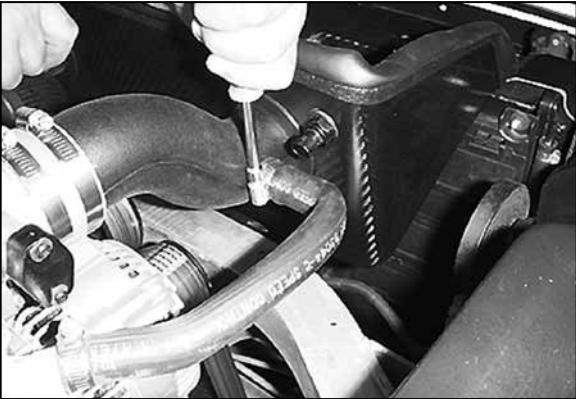

28. Connect the speed control hose to the vent on the intake tube and secure with existing hose clamp.



29. Reconnect the air temperature electrical connection.



30. Install the K&N® air filter elements onto the intake tubes and secure with hose clamps.

31. Reconnect the vehicle's negative battery cable. Double check to make sure everything is tight and properly positioned before starting the vehicle.

32. The C.A.R.B. exemption sticker, (attached), must be visible under the hood so that an emissions inspector can see it when the vehicle is required to be tested for emissions. California requires testing every two years, other states may vary.

33. It will be necessary for all K&N® high flow intake systems to be checked periodically for realignment, clearance and tightening of all connections. Failure to follow the above instructions or proper maintenance may void warranty.

ROAD TESTING:

1. Start the engine with the transmission in neutral or park, and the parking brake engaged. Listen for air leaks or odd noises. For air leaks secure hoses and connections. For odd noises, find cause and repair before proceeding. This kit will function identically to the factory system except for being louder and much more responsive.

2. Test drive the vehicle. Listen for odd noises or rattles and fix as necessary.

3. If road test is fine, you can now enjoy the added power and performance from your kit.

4. K&N Engineering, Inc., requires cleaning the intake system's air filter element every 100,000 miles. When used in dusty or off-road environments, our filters will require cleaning more often. We recommend that you visually inspect your filter once every 25,000 miles to determine if the screen is still visible. When the screen is no longer visible some place on the filter element, it is time to clean it. To clean and re-oil, purchase our filter Recharger® service kit, part number 99-5050 or 99-5000 and follow the easy instructions.

INTAKE SYSTEMS FOR VEHICLES LISTED ARE 50 STATE LEGAL. SEE KNFILTERS.COM FOR CARB STATUS ON EACH PART FOR A SPECIFIC VEHICLE.