

advanced FLOW engineering Track Series Cold Air Intake System

Instruction Manual P/N: 57-10001R / 57-10001D

Make: Dodge	Model: Challenger SRT Demon	Year: 2018	Engine: V8-6.2L(sc)
Make: Dodge	Model: Challenger SRT Hellcat Redeye	Year: 2019-2020	Engine: V8-6.2L(sc)



- Please read the entire instruction manual before proceeding.
- Ensure all components listed are present.
- If you are missing any of the components, call customer support at 951-493-7185.
- Ensure you have all necessary tools before proceeding.
- Do not attempt to work on your vehicle when the engine is hot.
- Retain factory parts for future use.

Label	Qty.	Description	Part Number
A1	1	Air Filter (Pro 5R)	24-90110-CF
A2	1	Air Filter (Pro DRY S)	21-90110-CF
B	1	Tube	05-5413021C1
C	1	Housing	05-5413021B2
D	1	Scoop	05-5413021B3
E	1	Coupling, Silicone Bellows	05-01495
F	1	Clamp, T-Bolt (4-1/16" – 4-3/8")	03-50262
G	1	Seal, Trim: 3/4" (5.5 Inches)	03-50007
H	1	Seal, Trim: 3/4" (4.5 Inches)	03-50007
I	1	Seal, Trim: 3/4" (3.5 Inches)	03-50007
J	1	Clamp, T-Bolt (4-9/16" – 4-7/8")	03-50319
K	1	Seal, Trim: 3/4" (41" Inches)	05-00007
L	2	Spring Clamp, 15/16" Hose (For Redeye Only)	03-50646
M	1	Silicone Hose 1/2" ID (20 Inches) (For Redeye Only)	05-01396
N	1	Elbow Fitting (For Redeye Only)	03-50165
O	1	Easy-install Snap-Grip Clamp (For Redeye Only)	03-50648

Installation will require the following tools:

8mm and 11mm nut driver or socket, flat screwdriver, blade and pliers.

Emissions Disclaimer: This product is not currently CARB exempt and is not available for purchase in California or for use on any vehicle registered with the California Department of Motor Vehicles.

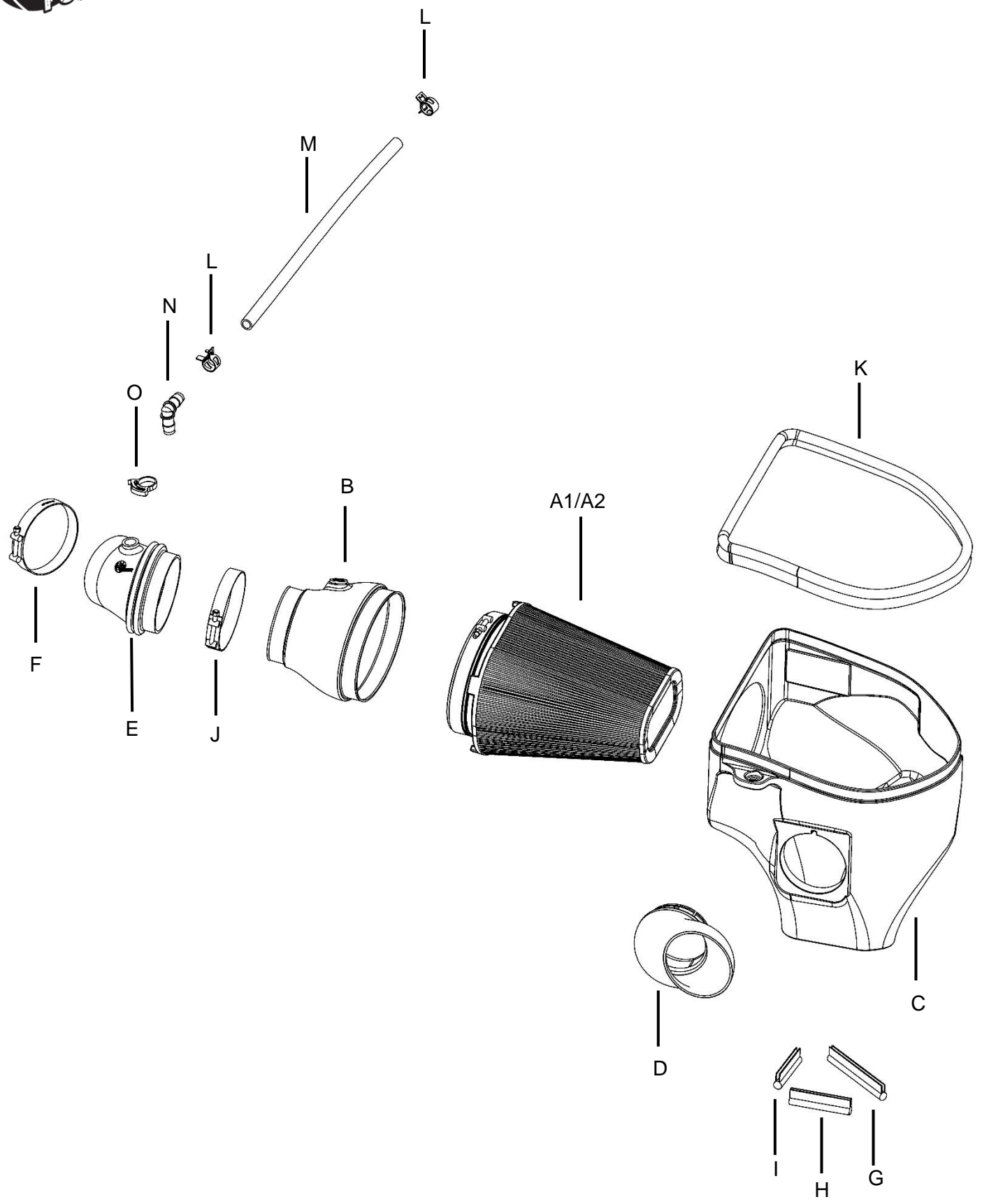

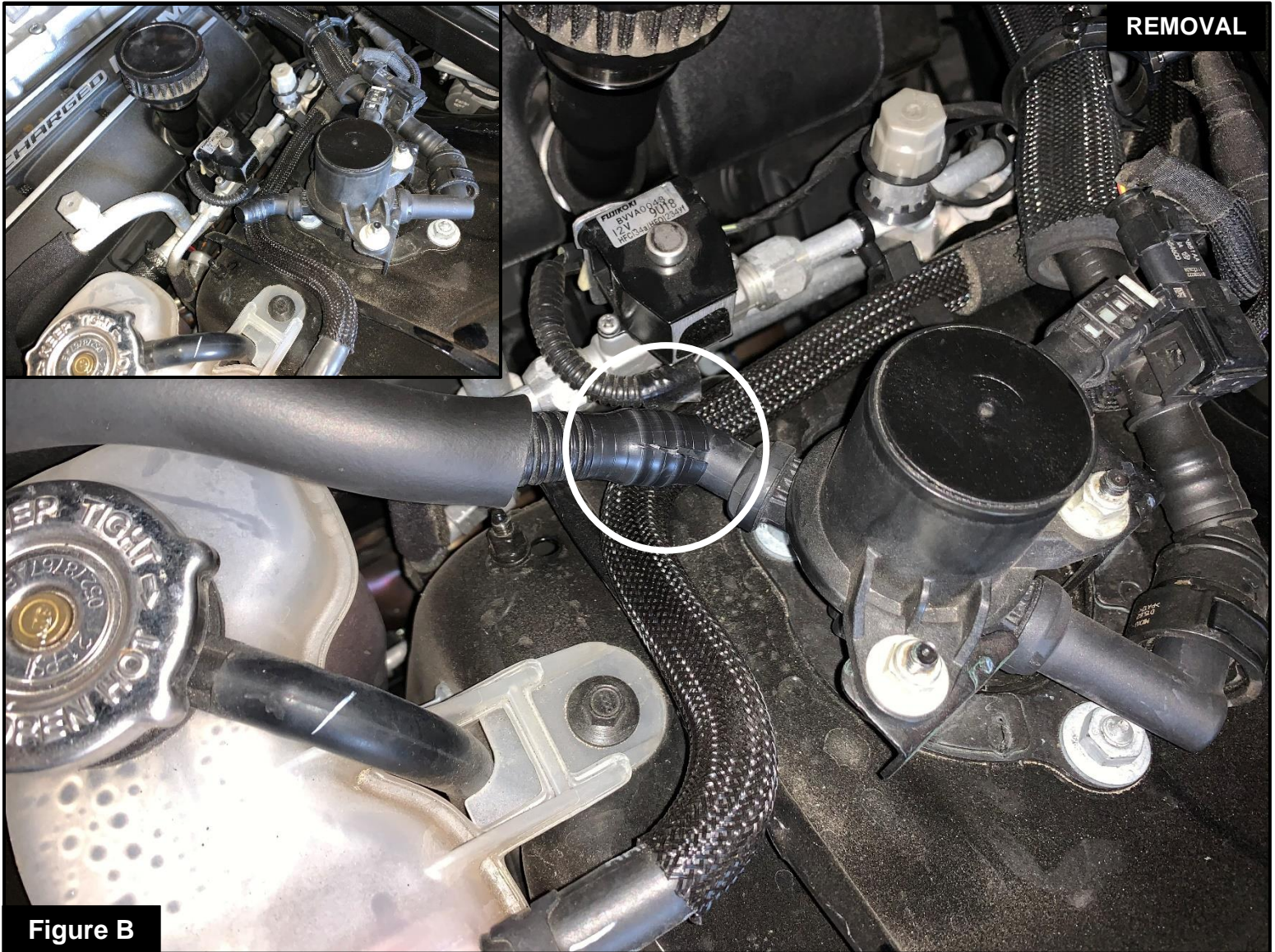

Figure A

Refer to Figure A for Steps 1-2

Step 1: Disconnect the temperature sensor from the engine harness.

Step 2: **(For SRT Demon only)** Disconnect the 90 degree fitting from the PCV hose.



Refer to Figure B for Step 3-4 (For SRT Hellcat Redeye Only)

Step 3: **(For SRT Hellcat Redeye Only)** Slice the plastic line connected to MUA system. Try to make the cut as clean as possible, if you ever need to reinstall the factory intake in the future. We suggest to use heat-shrink sleeve to cover the cut if needed.

Step 4: **(For SRT Hellcat Redeye Only)** Disconnect the plastic hose from the MUA system. A silicone hose is provided to connect the aFe POWER tube to the MUA system.

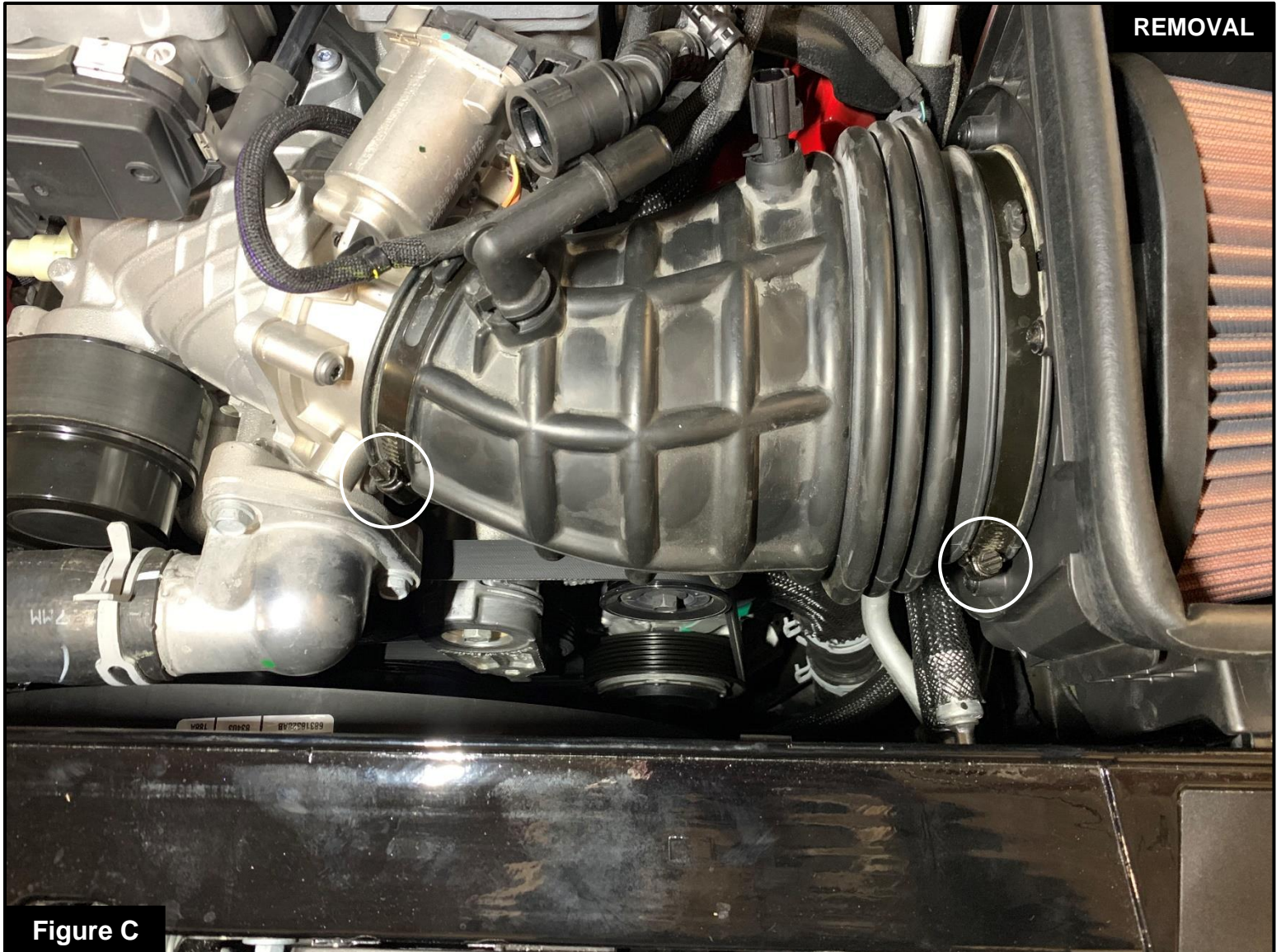

Figure C

Refer to Figure C for Steps 5-6

Step 5: Using an 8mm nut driver, Loosen the two clamps securing the factory intake tube.

Step 6: Remove the factory intake tube from the vehicle. For the SRT Hellcat Redeye, the tube will be come with the solid plastic line disconnected from the MUA system.



Figure D

Refer to Figure D for Step 7-8

Step 7: Remove the 8mm bolt securing the factory airbox.

Step 8: Remove the factory airbox and scoop from the vehicle as one piece.



Refer to Figure E for Step 9-11

Step 9: Transfer the metal sleeve and grommet from the factory airbox to the aFe POWER airbox.

Step 10: Install the provided trim seal around the top edge of the airbox and the three short trim seals on the bottom edges of the airbox.

Step 11: Install the aFe POWER dynamic air scoop (D.A.S) into the airbox.



Figure F

Refer to Figure F for Steps 12

Step 12: Install the aFe POWER airbox into the vehicle. Do not install the 8mm bolt yet.



Figure G

Refer to Figure G for Step 13

Step 13: Install the air filter into the aFe POWER airbox. Push it in the oval opening from the inside of the housing until the filter lip locks into place.

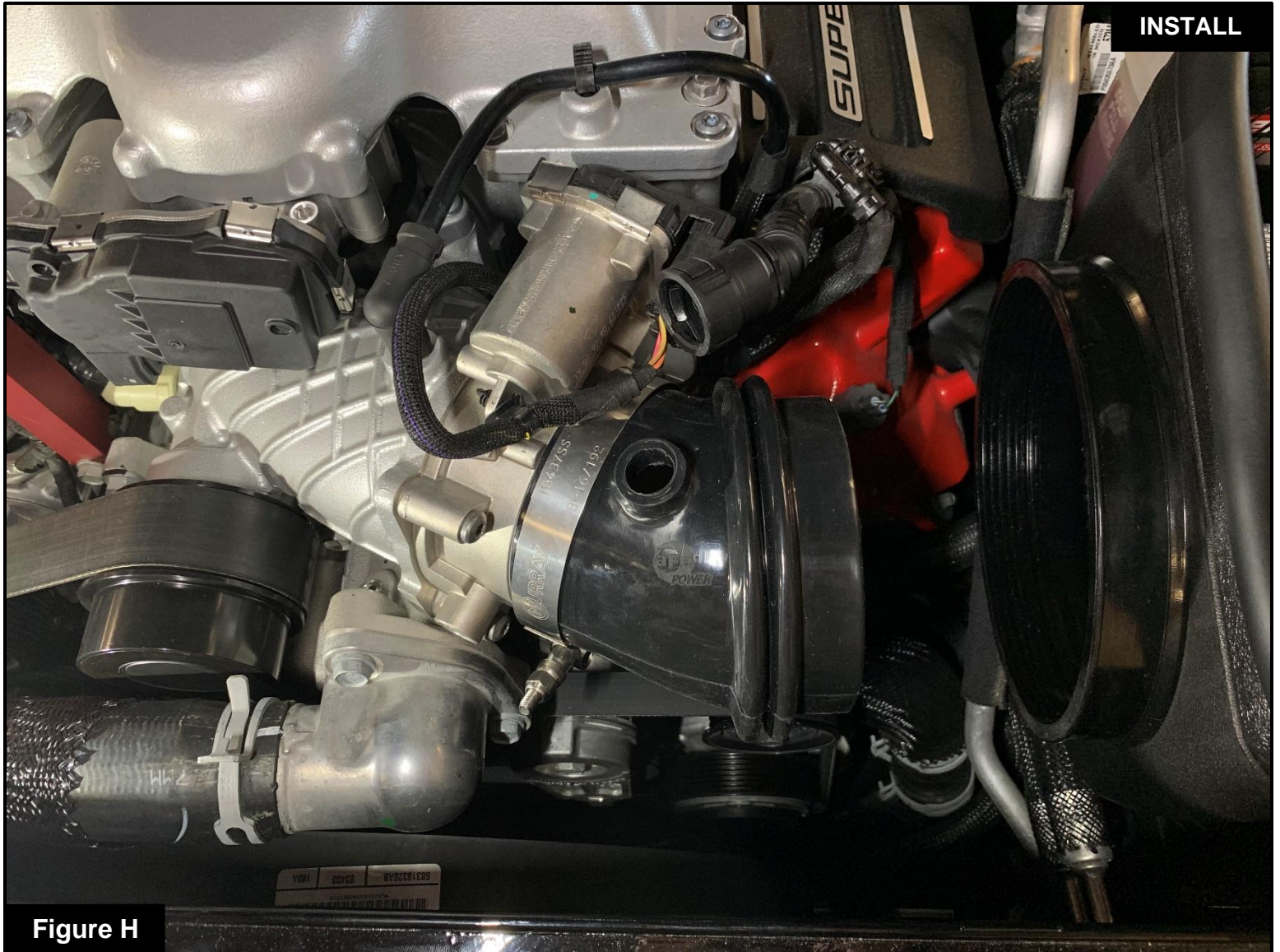

Figure H

Refer to Figure H for Step 14

Step 14: Install the coupling on the throttle body. Install with the clamp closest to the throttle body only, do not tighten clamp yet.



Figure I

Refer to Figure I for Steps 15

Step 15: Install the aFe POWER intake tube, by sliding the tube into the filter first and then the coupling.

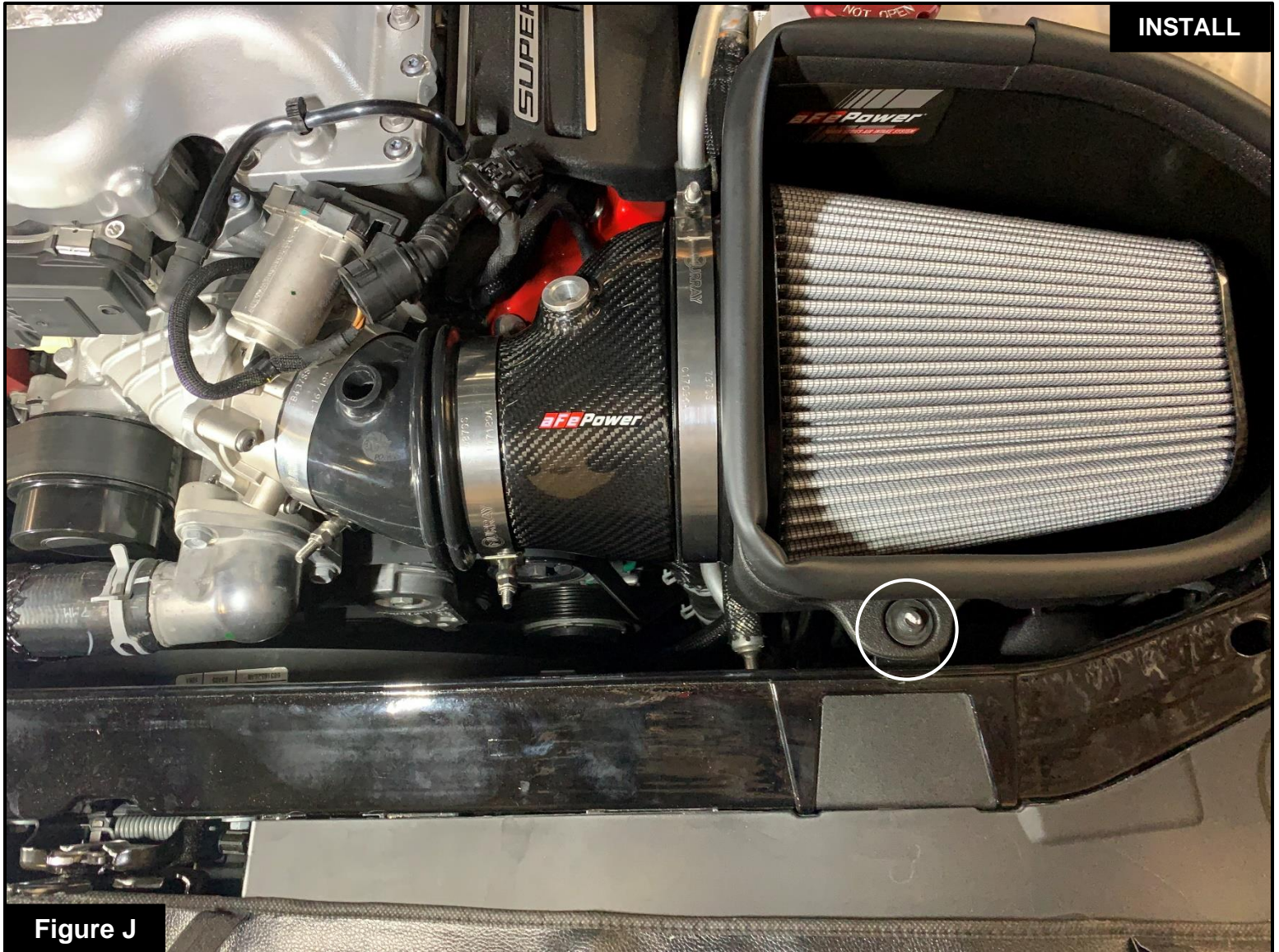

Figure J

Refer to Figure J for Steps 16-18

Step 16: Open the two (2) remaining clamps and install them around the filter and intake tube.

Step 17: Adjust the tube and coupling as needed and then tighten all clamps.

Step 18: Install the 8mm bolt removed in Step 5 to secure the aFe POWER airbox.

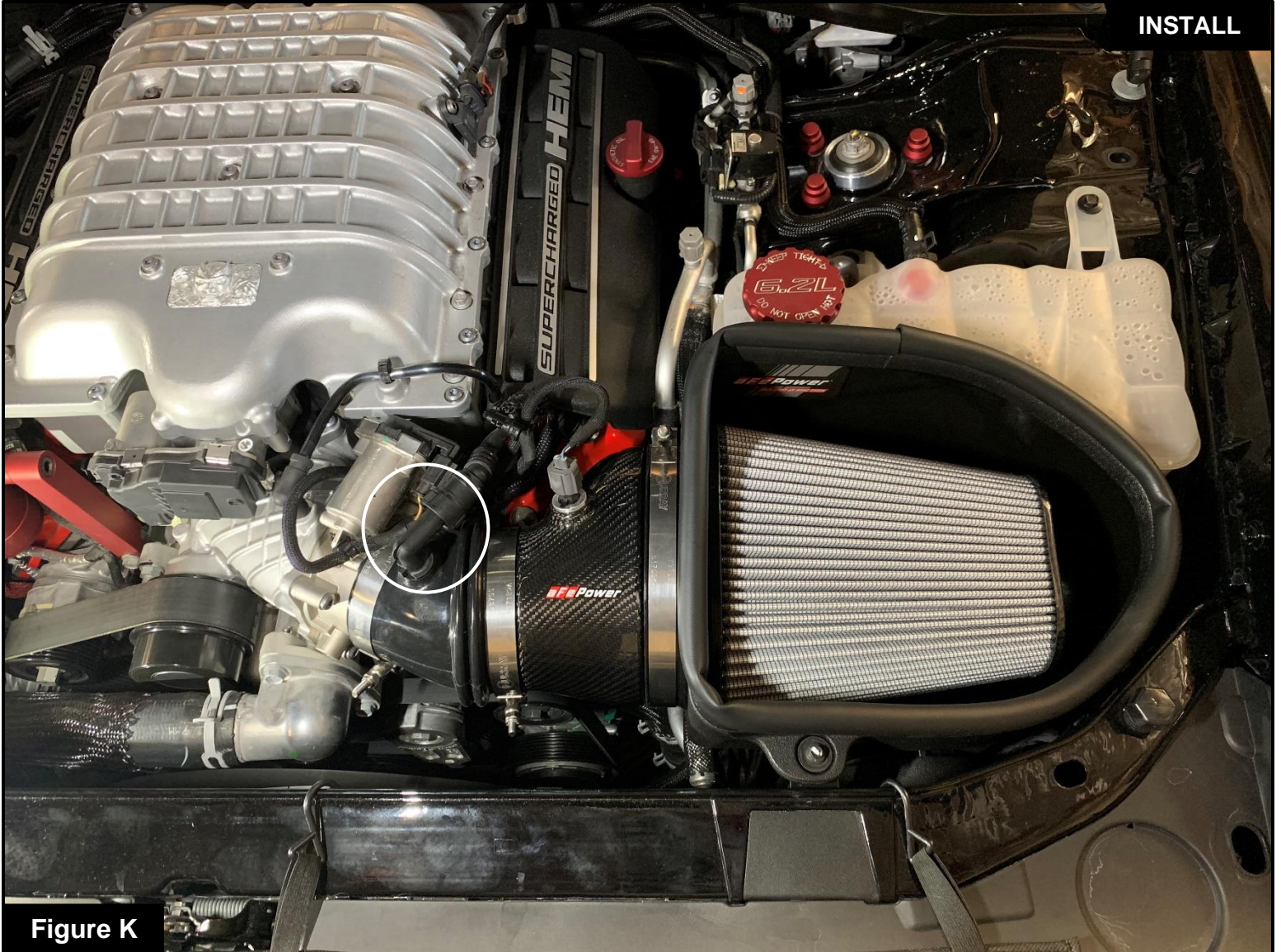
**Figure K****Refer to Figure K for Steps 19 (For SRT Demon Only)**

Step 19: **(For SRT Demon only)** Transfer the plastic 90 degree fitting from the factory intake tube to the aFe POWER coupling and connect to the PCV hose.

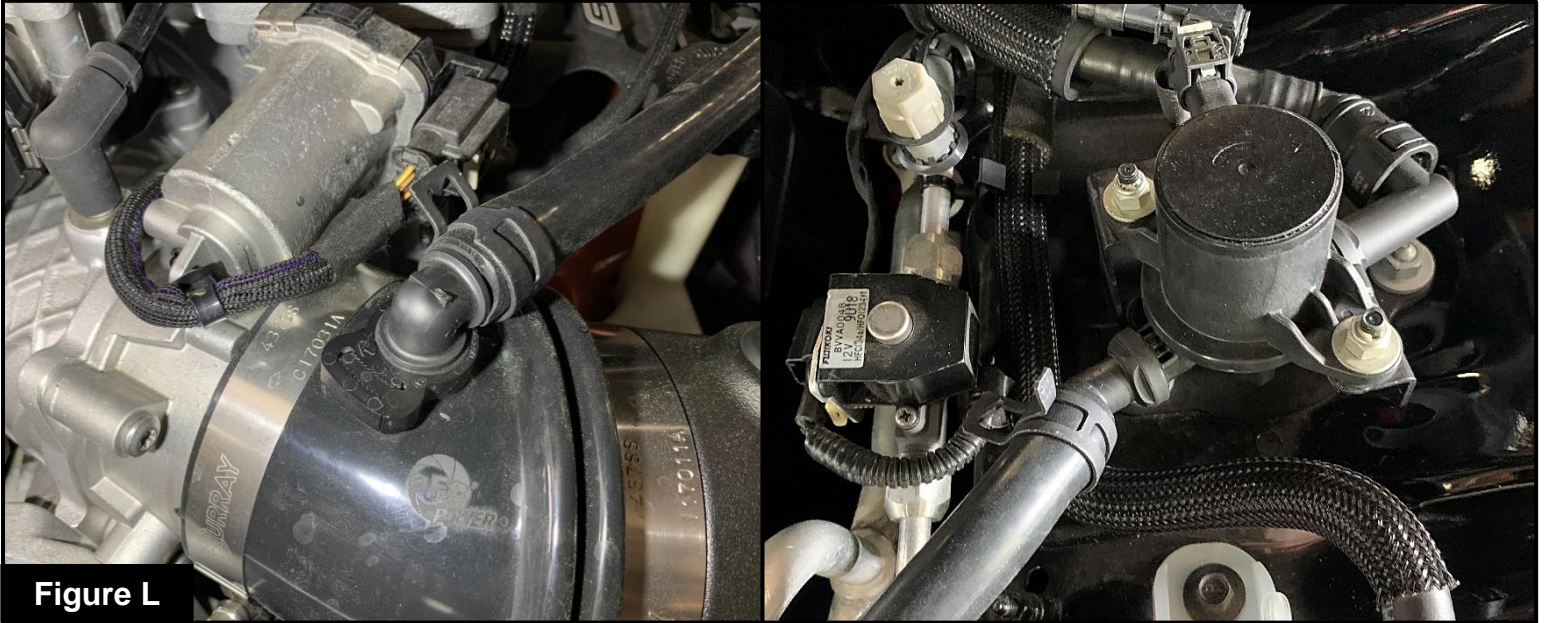
Figure L

Refer to Figure L for Steps 20-21 (For SRT Hellcat Redeye Only)

Step 20: (For SRT Hellcat Redeye Only) Install the two spring clamps over the provided silicone hose (deep enough on the hose so you can still install a fitting into the hose). Press the 90 Degree elbow fitting into one end of the hose.

Step 21: (For SRT Hellcat Redeye Only) Place the Snap-Grip Clamp over the hole onto the coupling mounted to the throttle body then press in the 90 Degree elbow fitting into it. Connect the other end of the silicone hose to the MUA system. Move the spring clamps on the hose to secure the hose connections and close the Snap-Grip clamp using pliers to secure the 90 Degree fitting into the coupling.

**Figure M****Refer to Figure M for Steps 22 (SRT Hellcat Redeye shown)**

Step 22: Transfer the temp sensor from the factory intake tube to the aFe POWER intake tube and connect it to the engine harness. Your installation is now complete. Thank you for choosing aFe POWER!

NOTE: Check all screws, clamps, and connectors are secure after 100-200 miles.



Page left blank intentionally



Pro DRY S Air Filter



P/N: 21-90110-CF

Pro 5R Air Filter



P/N: 24-90110-CF

Pro DRY S Air Filter



P/N: 21-90110

Pro 5R Air Filter



P/N: 24-90110

Blue Squeeze Restore Kit



P/N: 90-50501

PRO DRY S Restore Kit



P/N: 40-33205-B

Pre-Filter



P/N: 40-10202

Mechanic Gloves (L)



P/N: 40-10149

To purchase any of the items above, view airflow charts, dyno graphs, photos, and video; please go to aFepower.com.



Warranty

General Terms:

- aFe warrants their products to be free from manufacturer's defects due to workmanship and material.
- This warranty applies only to the original purchaser of the product and is non-transferrable.
- Proof of purchase of the aFe product is required for all warranty claims.
- Warranty is valid provided aFe instructions for installation and/or cleaning were properly followed.
- Proper maintenance with regular inspections of product is required to insure warranty coverage.
- Damage due to improper installation, abuse, unauthorized repair or alteration is not warranted.
- Incidental or consequential damages or cost, including installation and removal of part, incurred due to failure of aFe product is not covered under this warranty.
- All warranty is limited to the repair and/or replacement of the aFe part. To request Return Goods Authorization ("RGA"), email RGA@afepower.com or call (951)493-7100. Upon receipt of the RGA, you must return the product to the address provided in the RGA, freight prepaid and accompanied with a dated proof of purchase and the RGA. Upon receipt of the defective product and upon verification of proof of purchase, aFe will either repair or replace the defective product within a reasonable time, not to exceed thirty days.

Product Category	P/N Prefix	Warranty duration
Direct OE Replacement Filters	10, 11, 30, 31, 71, 73	Life of the vehicle
Racing Filters	18	1 year
Universal	20, 21, 23, 24, 72, TF	2 years
Air Intake Systems	50, 51, 53, 54, 55, 56, 57, 58, 75, TR, TA, TL, TM	2 years
Exhaust Systems	49	2 years
Intercoolers & Intercooler Tubes	46-2	2 years
Intake Manifolds	46-1	2 years
Differential Cover	46-7	Life of the vehicle
Exhaust Manifolds	46	2 years
Throttle Body Spacers	46-3	2 years
Turbochargers	46-6	2 years*
Fluid Filters	44	90 days
Pre-Filters	28	2 years
Heavy Duty OE Replacement	70	2 years
PowerSports OE Replacement	81, 87	2 years
PowerSports Intake Systems	85	2 years

No other warranty expressed or implied applies nor is any person or advanced FLOW engineering authorized to assume any other warranty. Some States do not allow the exclusion or limitation of incidental or consequential damages or do not allow limitations on how long an implied warranty lasts, so the above limitations or exclusions may not apply to you. This warranty gives you specific legal rights, and you may also have other rights which vary from State to State.

*See turbocharger warranty for more info



advanced FLOW engineering, inc.

252 Granite Street Corona, CA 92879
TEL: 951.493.7100 • TECH: 951.493.7185
E-Mail: Tech@aFepower.com

P/N: 06-81176