

advanced FLOW engineering

Instruction Manual P/N: 51-74210 & 54-74210

Make: **Chevrolet** Model: **Camaro SS** Year: **2016-2017** Engine: **V8-6.2L**



- Please read the entire instruction manual before proceeding.
- Ensure all components listed are present.
- If you are missing any of the components, call customer support at 951-493-7100.
- Ensure you have all necessary tools before proceeding.
- Do not attempt to work on your vehicle when the engine is hot.

Retain factory parts for future use.

Label	Qty.	Description	Part Number
A1	1	Air Filter (Pro 5R)	24-91092
A2	1	Air Filter (Pro DRY S)	21-91092
B	1	Tube	05-74210B1
C	1	Housing	05-74210B2
D	1	Clamp, #16	03-50091
E	1	Coupling, Silicone Elbow	05-01392
F	1	Fitting, Vent	03-01339
G	2	T-bolt Clamp	05-50262
H	2	Screw, M4	03-50491
I	1	Plug, Urethane	05-00937
J	1	Scoop	05-74210B3

Installation will require the following tools:

8mm nut driver, 11mm deep socket & driver, T20 Torx, flathead screwdriver, 20mm wrench or adjustable wrench and pliers.

Note: Legal in California for use on race vehicles only. The use of this device on vehicles used on public streets or highways is strictly prohibited in California and others states that have adopted California emission regulations.

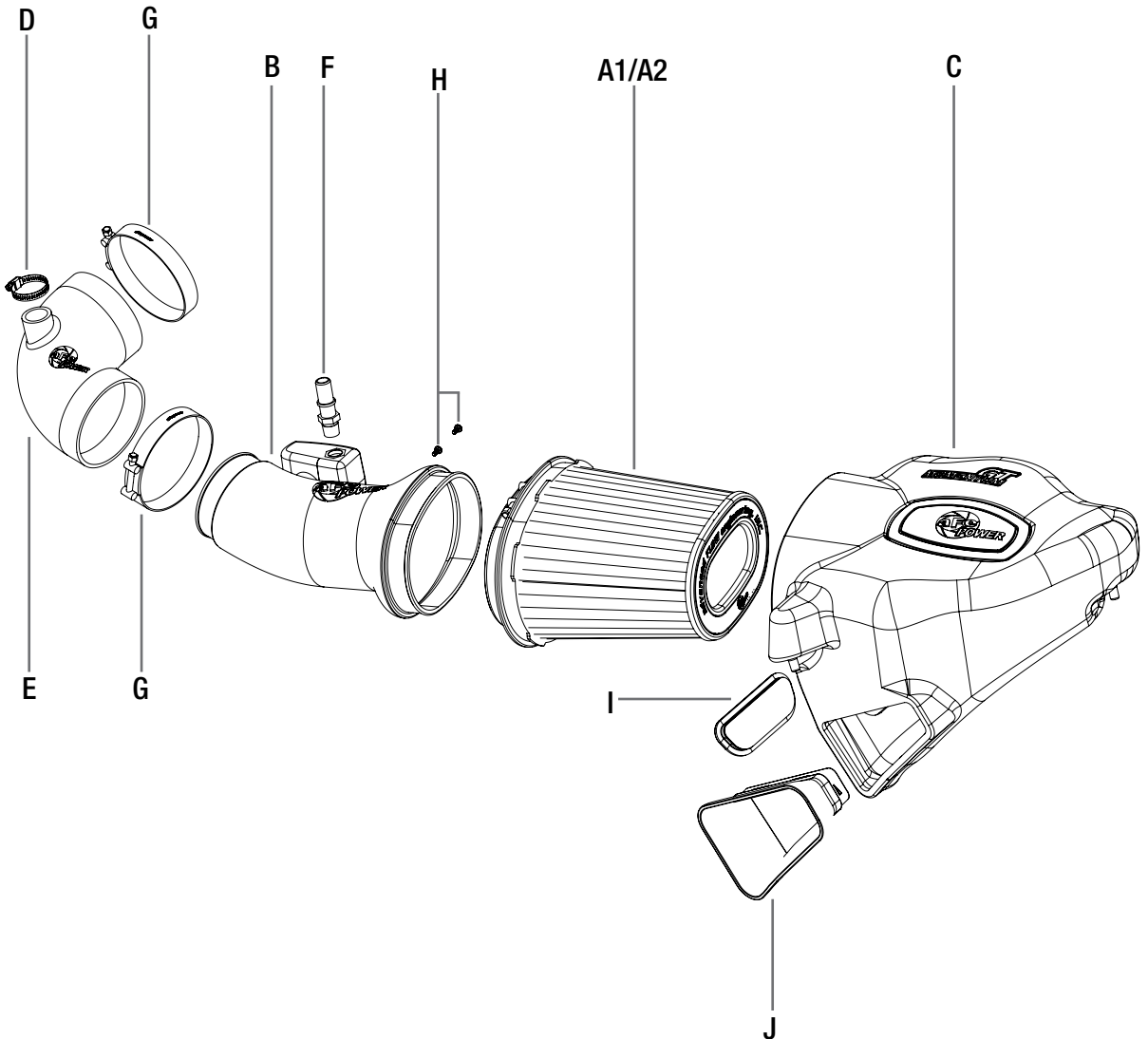

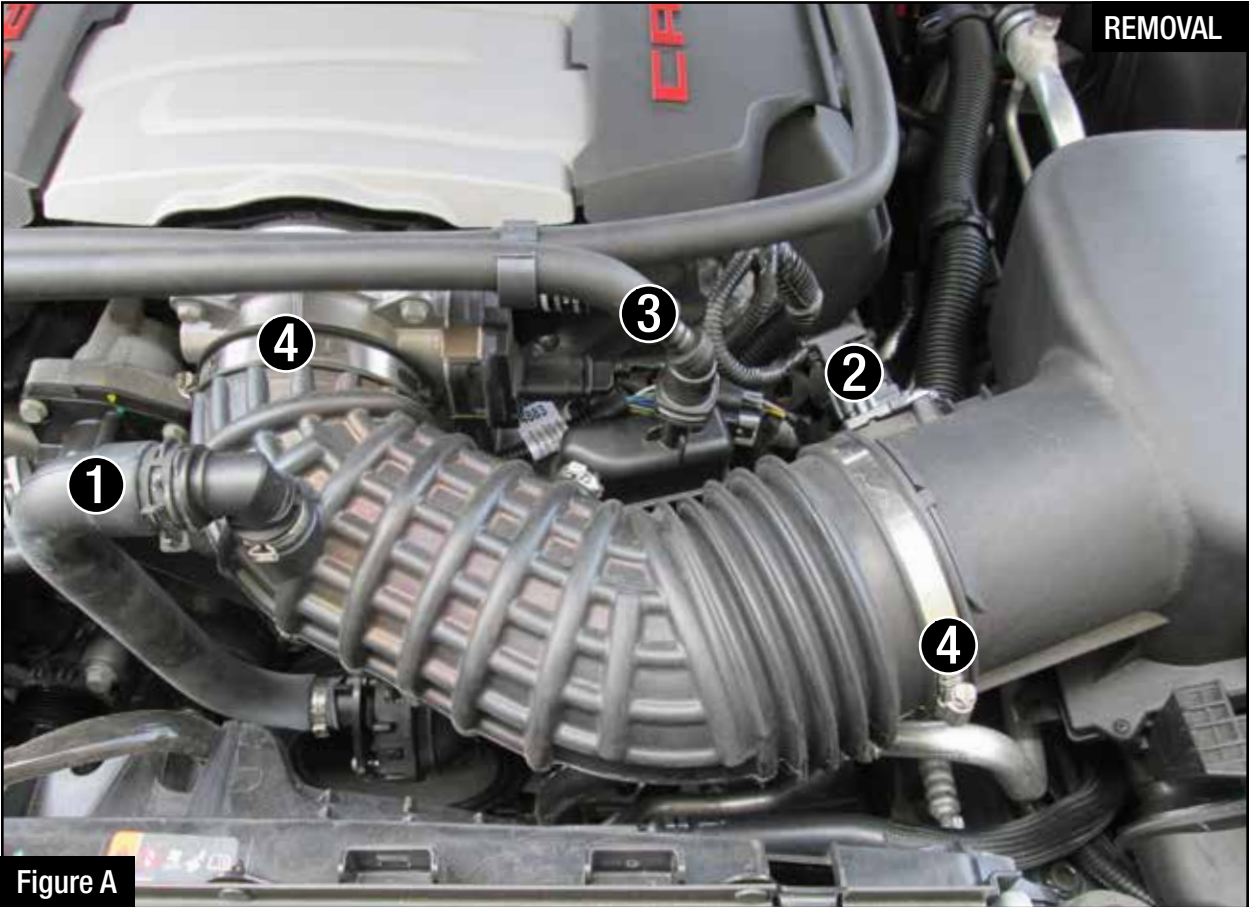
**Figure A****Refer to Figure A for Steps 1-2**

Step 1: Using a pair of pliers, disconnect the sound hose (1) from the intake tube. Disconnect the MAF sensor (2) and the breather hose (3) from the intake tube .

Step 2: Use an 8mm nut driver to loosen the stock clamps (4) at the throttle body and the air box. Remove the stock intake tube.

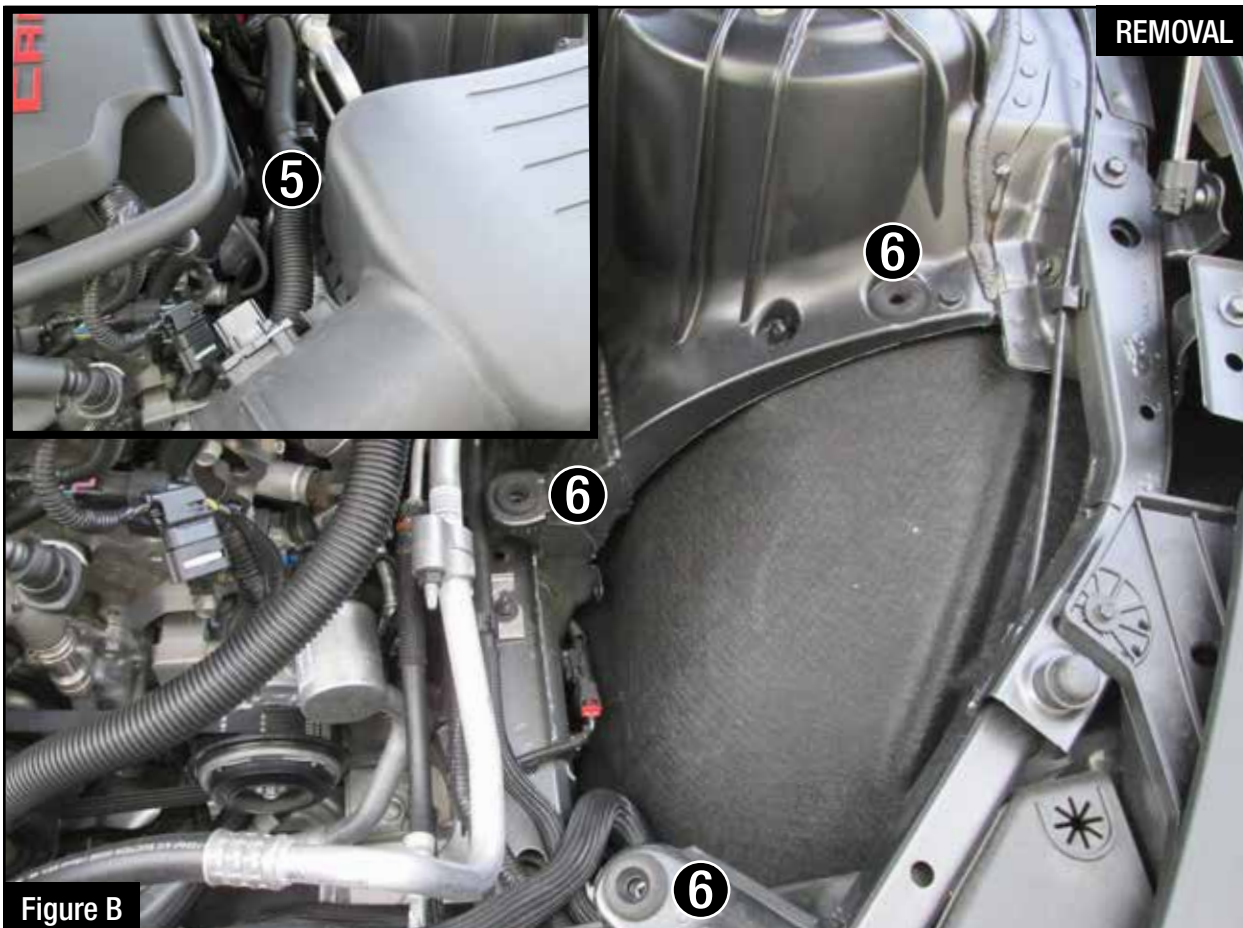

Figure B

Refer to Figure B for Steps 3-4

Step 3: Remove the air hose from the captive clamp (5) and move it to the side.

Step 4: Remove the air box by pulling up to release air box from its mounting grommets (6). Make sure the mounting grommets (6) are still in the chassis mounting tabs. If they pulled out and are stuck in the lower half of the air box, remove them from the air box and insert them back on the chassis mounting tabs.



Figure C

Refer to Figure C for Steps 5-6

Step 5: Install the supplied air inlet scoop (7) into the aFe air box.

Step 6: Use the provided plug (8) to close additional air inlet if you want to completely seal the air box.

Best performance gain is obtained by having more air flow (no plug).



Figure D

Refer to Figure D for Step 7

Step 7: Slide the aFe filter and clamp into the aFe housing and push it in until it locks into place. Do not tighten clamp at this time.



Figure E

Refer to Figure E for Step 8

Step 8: Install the housing assembly into the vehicle by pushing down air box pins into the rubber grommets. Make sure the pins are completely through the mounting grommets.



Figure F

Refer to Figure F for Step 9

Step 9: Using a Torx 20 driver remove the mass air flow sensor (8) from the upper half of the air box and set it aside.



Refer to Figure G for Step 10

Step 10: Install the supplied aluminum vent fitting (9) into the aFe intake tube using a 20mm wrench or adjustable wrench.

Install the mass air flow sensor (10) in the aFe intake tube using the two supplied M4 screws.

INSTALL



Figure H

Refer to Figure H for Step 11

Step 11: Install the aFe intake tube into the air filter.

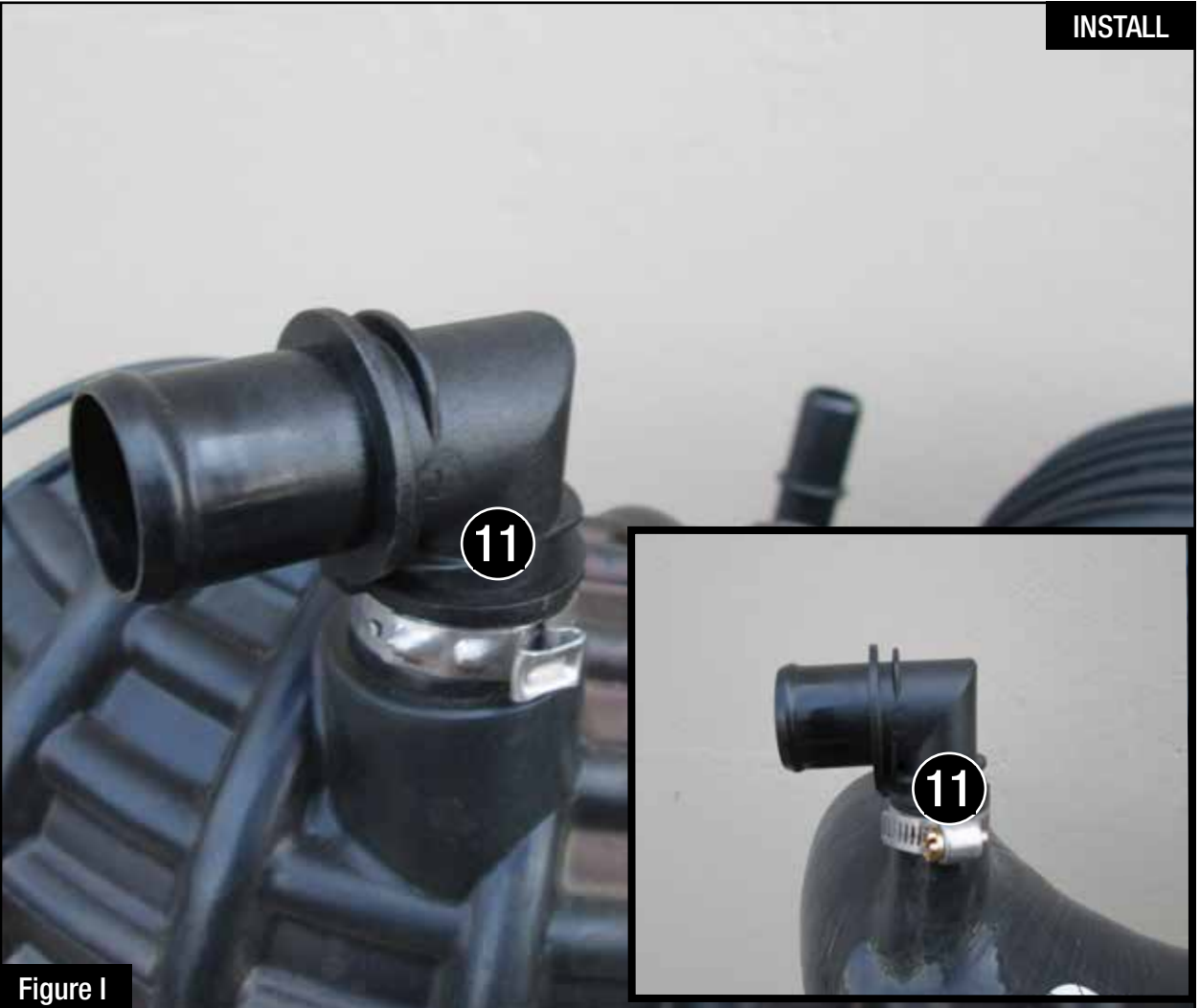

Figure I

Refer to Figure I for Step 12

Step 12: Remove the elbow fitting (11) from the intake hose by prying the clamp with a flathead screwdriver and install it on the supplied silicone coupler with the supplied mini clamp.

INSTALL



Figure J

Refer to Figure J for Step 13

Step 13: Install the silicone coupler with the supplied T-clamps onto the throttle body and intake tube. Tighten all clamps.

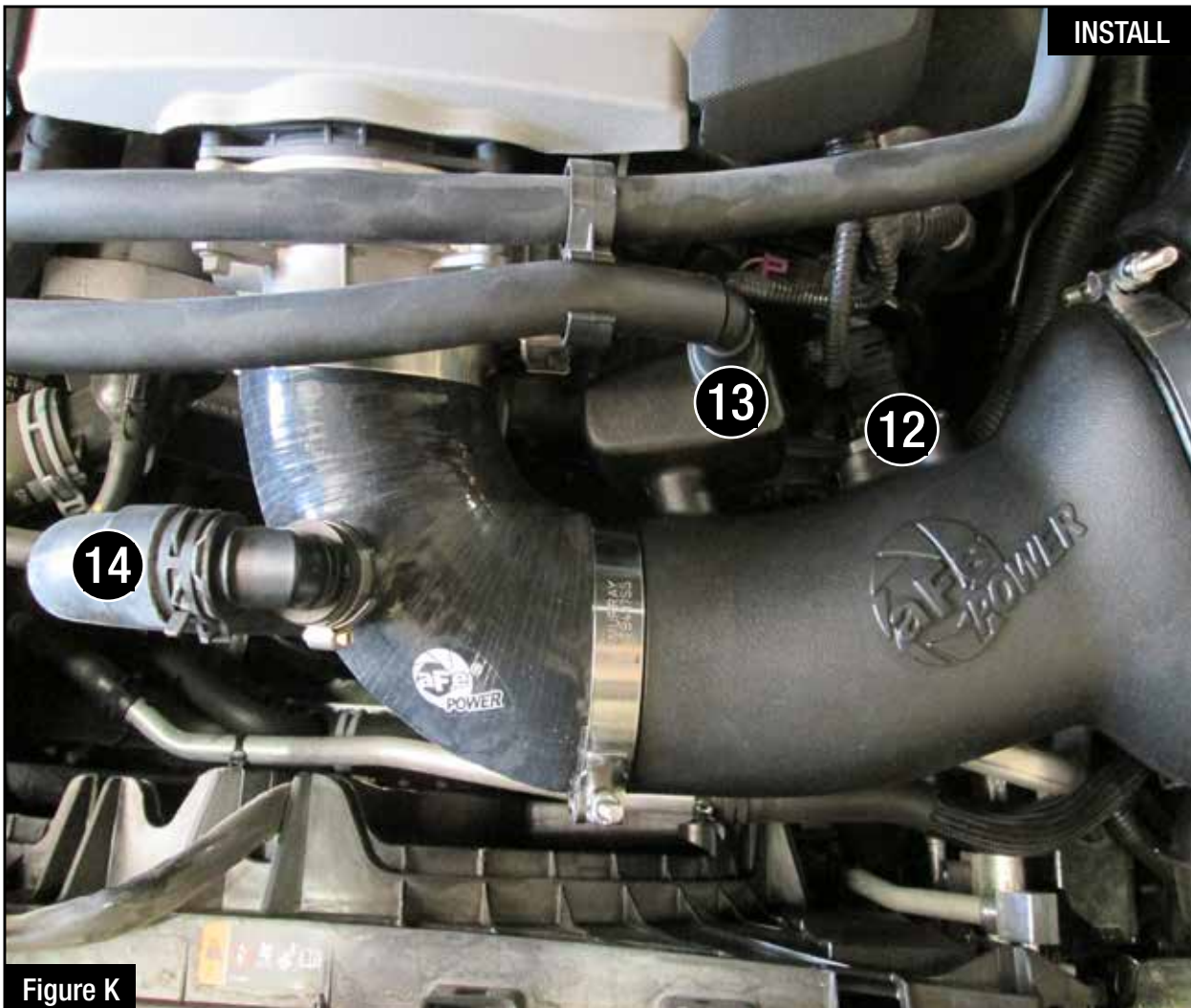

Figure K

Refer to Figure K for Step 14

Step 14: Connect the mass air flow sensor (12), breather hose (13) and sound hose (14). Check all the components are tight and secure.



Figure L

Refer to Figure L for Step 15

Step 15: Your installation is now complete.

NOTE: Check all bolts, clamps, and connectors after 200 miles.



Page left blank intentionally

Page left blank intentionally



Pro DRY S Air Filter



P/N: 21-91092

Pro 5R Air Filter



P/N: 24-91092

Pre-Filter



P/N: 28-10283

Pro DRY S Restore Kit



P/N: 90-59999

Blue Squeeze Restore Kit



P/N: 90-50501

Headers w/ X-Pipe



P/N: 48-34127-YC (Street)
48-34127-YN (Race)

Lowering Springs

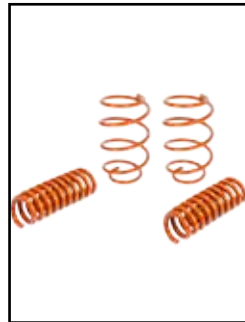

P/N: 410-402002-N

Sway Bars

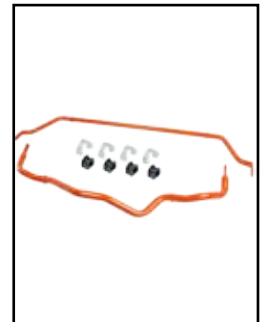

P/N: 440-402002-N

aFe T-Shirt



P/N: 40-30382 (M)
40-30383 (L)
40-30384 (XL)

To purchase any of the items above, view airflow charts, dyno graphs, photos, and video; please go to aFepower.com.

Warranty

General Terms:

- aFe warrants their products to be free from manufacturer's defects due to workmanship and material.
- This warranty applies only to the original purchaser of the product and is non-transferrable.
- Proof of purchase of the aFe product is required for all warranty claims.
- Warranty is valid provided aFe instructions for installation and/or cleaning were properly followed.
- Proper maintenance with regular inspections of product is required to insure warranty coverage.
- Damage due to improper installation, abuse, unauthorized repair or alteration is not warranted.
- Incidental or consequential damages or cost, including installation and removal of part, incurred due to failure of aFe product is not covered under this warranty.
- All warranty is limited to the repair and/or replacement of the aFe part. To request Return Goods Authorization ("RGA"), email RGA@afepower.com or call (951)493-7100. Upon receipt of the RGA, you must return the product to the address provided in the RGA, freight prepaid and accompanied with a dated proof of purchase and the RGA. Upon receipt of the defective product and upon verification of proof of purchase, aFe will either repair or replace the defective product within a reasonable time, not to exceed thirty days.

Product Category	P/N Prefix	Warranty duration
Direct OE Replacement Filters	10, 11, 30, 31, 71, 73	Life of the vehicle
Racing Filters	18	1 year
Universal	21, 24, 72, TF	2 years
Air Intake Systems	50, 51, 54, 55, 75, TR, TA, TL	2 years
Exhaust Systems	49	2 years
Intercoolers & Intercooler Tubes	46-2	2 years
Intake Manifolds	46-1	2 years
Differential Cover	46-7	Life of the vehicle
Exhaust Manifolds	46	2 years
Throttle Body Spacers	46-3	2 years
Turbochargers	46-6	2 years*
Fluid Filters	44	90 days
Pre-Filters	28	2 years
Heavy Duty OE Replacement	70	2 years
PowerSports OE Replacement	81, 87	2 years
PowerSports Intake Systems	85	2 years

No other warranty expressed or implied applies nor is any person or advanced FLOW engineering authorized to assume any other warranty. Some States do not allow the exclusion or limitation of incidental or consequential damages or do not allow limitations on how long an implied warranty lasts, so the above limitations or exclusions may not apply to you. This warranty gives you specific legal rights, and you may also have other rights which vary from State to State.

*See turbocharger warranty for more info



advanced FLOW engineering, inc.
252 Granite Street Corona, CA 92879
TEL: 951.493.7100