

**advanced FLOW engineering** Cold Air Intake System

**Instruction Manual** P/N: 52-10018D / 52-10018R

Make: Volkswagen

Model: GTI (MK8)

Year: 2022+

Engine: L4-2.0L (t)



- Please read the entire instruction manual before proceeding.
- Ensure all components listed are present.
- For technical support please call 951-493-7185.
- Ensure you have all necessary tools before proceeding.
- Do not attempt to work on your vehicle when the engine is hot.
- Retain factory parts for future use.

Label	Qty.	Description	Part Number
A1	1	Air Filter (Pro 5R)	24-90069
A2	1	Air Filter (Pro DRY S)	21-90069
B	1	Housing	05-12672B2
C	1	Intake Tube	05-5210018B1
D	1	Coupling, Silicone Reducer	05-01528
E	2	Clamp, #048	03-50007
F	1	Seal Trim	05-00072
G	1	Hose, Vacuum: 5/32" ID, Black: 10"	05-00122

**Installation will require the following tools:**

7mm & 8mm nut drivers, and Torx T25 driver.

Warranty Information available at <https://afepower.com/contact#warranty>

**Emissions Disclaimer:** This product is not currently CARB exempt and is not available for purchase in California or for use on any vehicle registered with the California Department of Motor Vehicles.

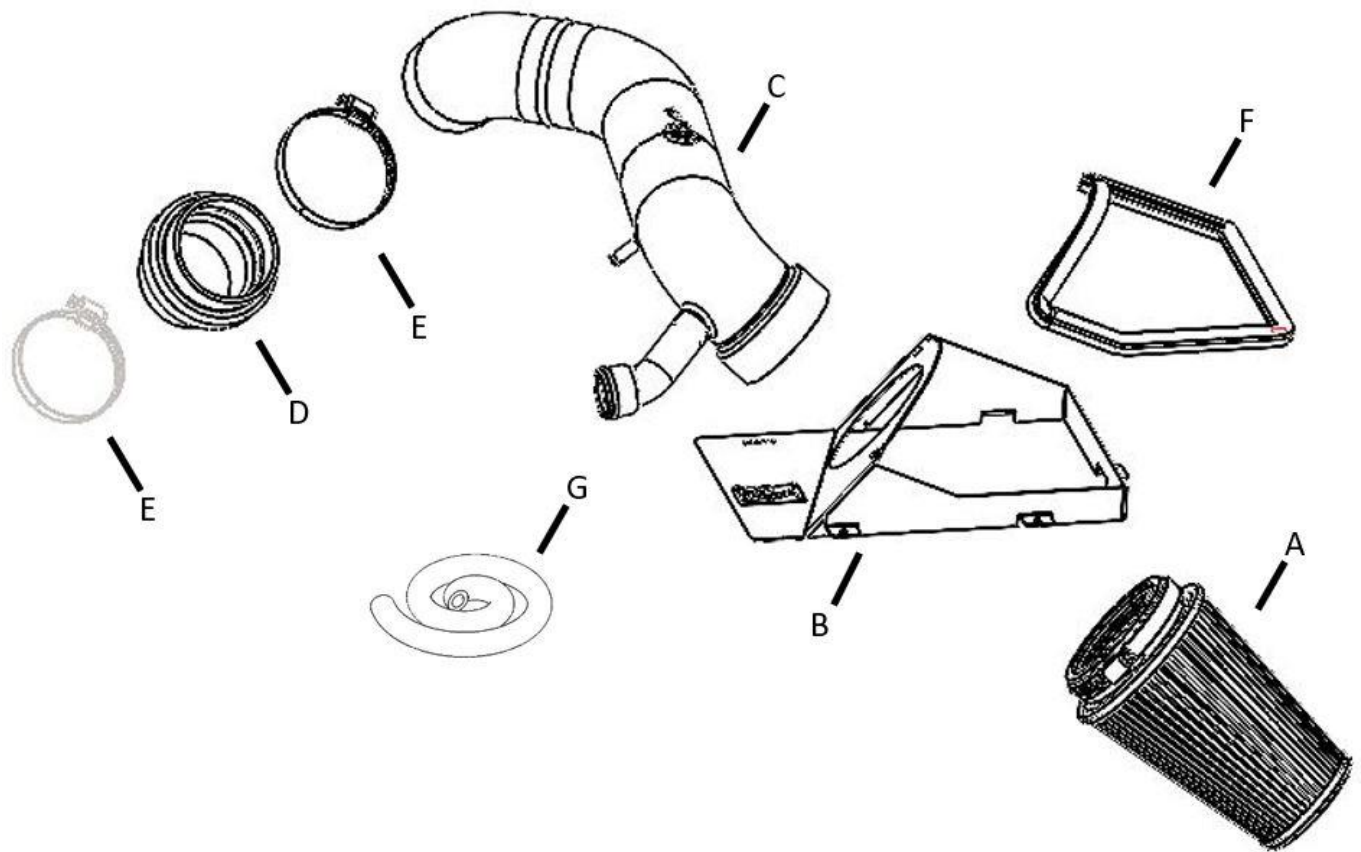

**Figure A****Refer to Figure A for Steps 1-2**

Step 1: Remove the engine cover, if equipped ①.

Step 2: Using a 7mm nut driver, loosen the clamp ② at the factory turbo inlet.

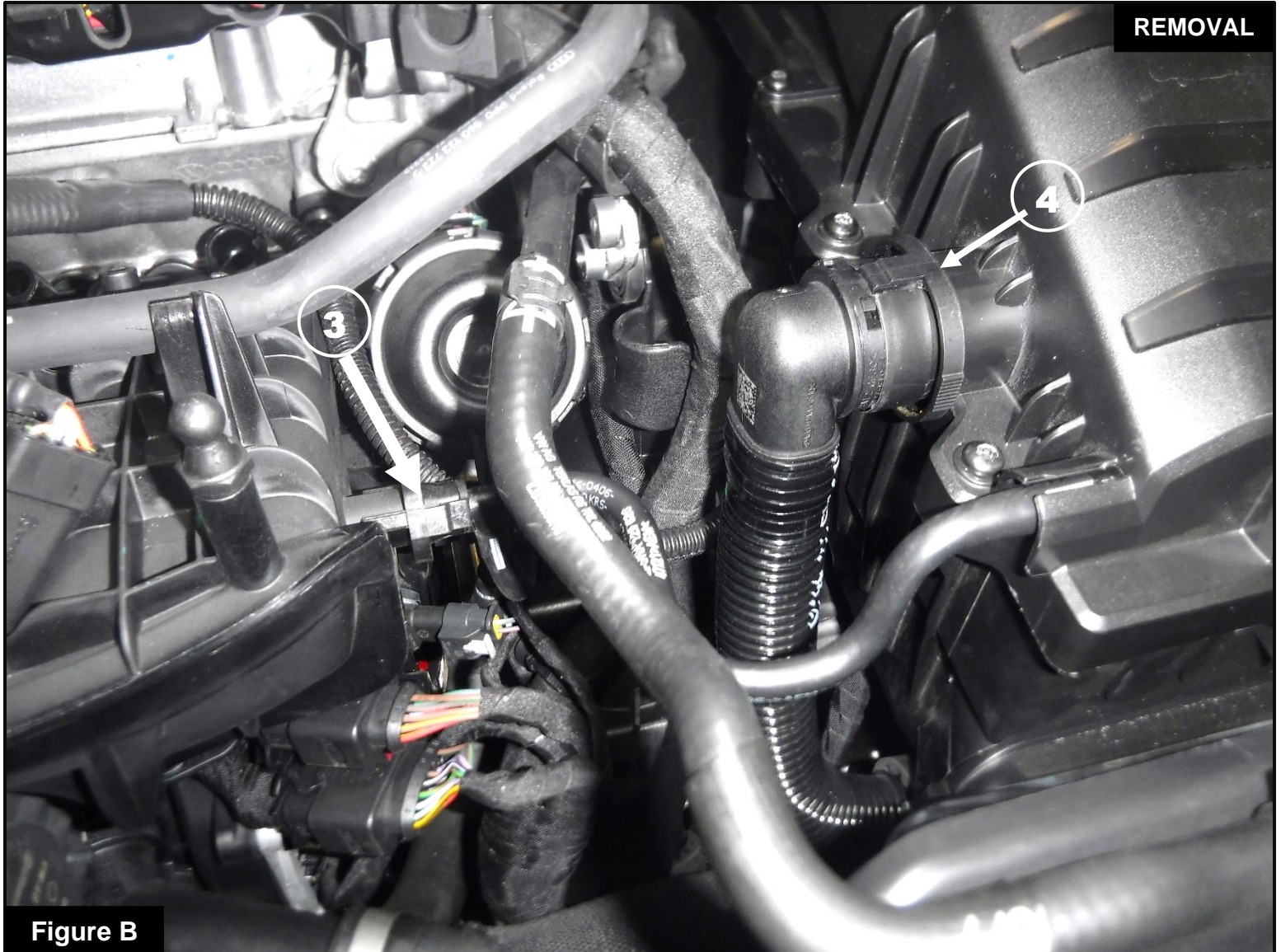

Figure B

**Refer to Figure B for Steps 3-6**

Step 3: Disconnect the CCV line (3) from the engine.

Step 4: Disconnect the smog pump fitting (4) from the factory air box lid.

Step 5: Using a T25 driver unscrew the seven screws securing the air box lid to the lower air box.

Step 6: Remove the factory air box lid and intake tube from the vehicle.

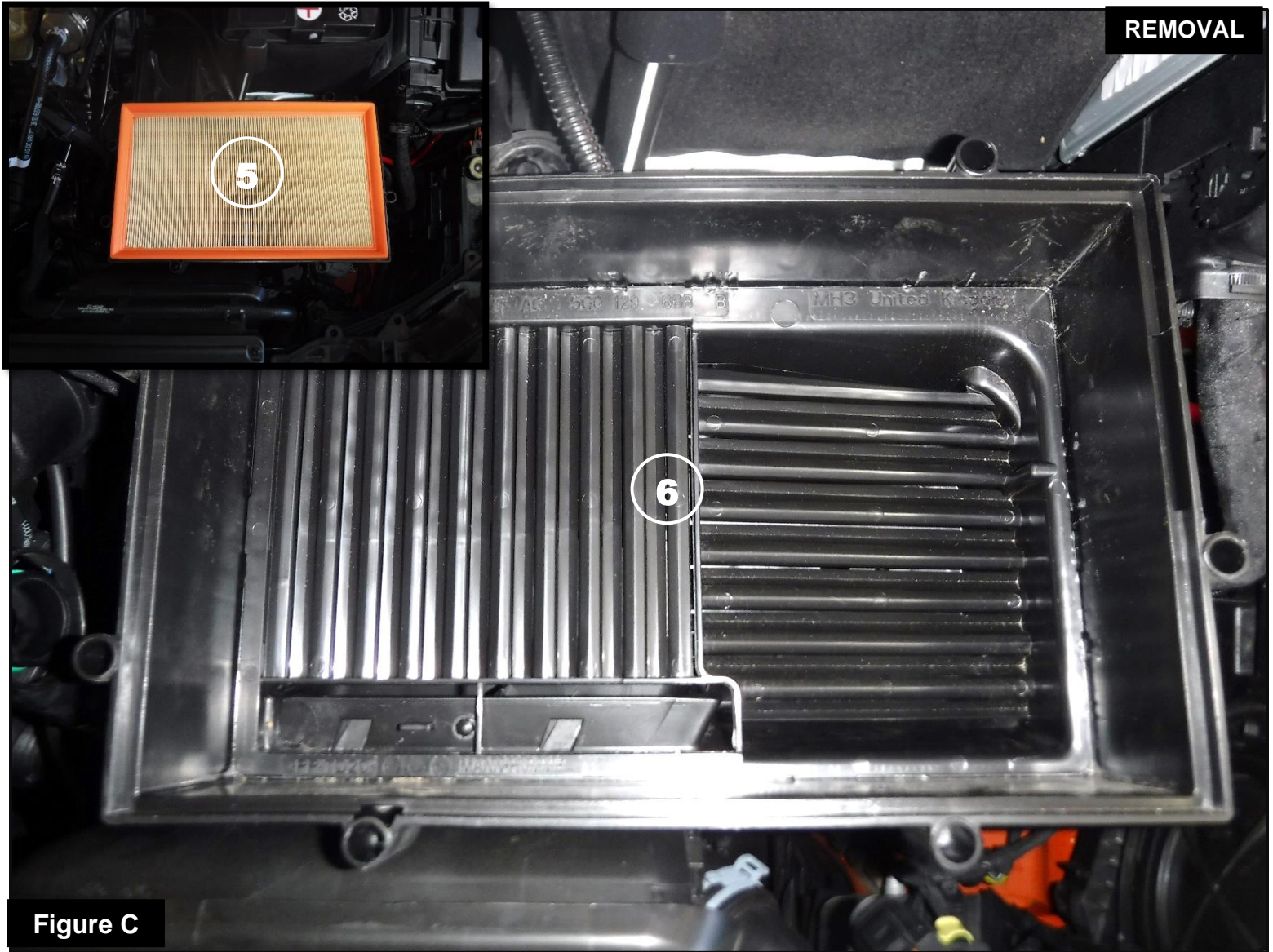
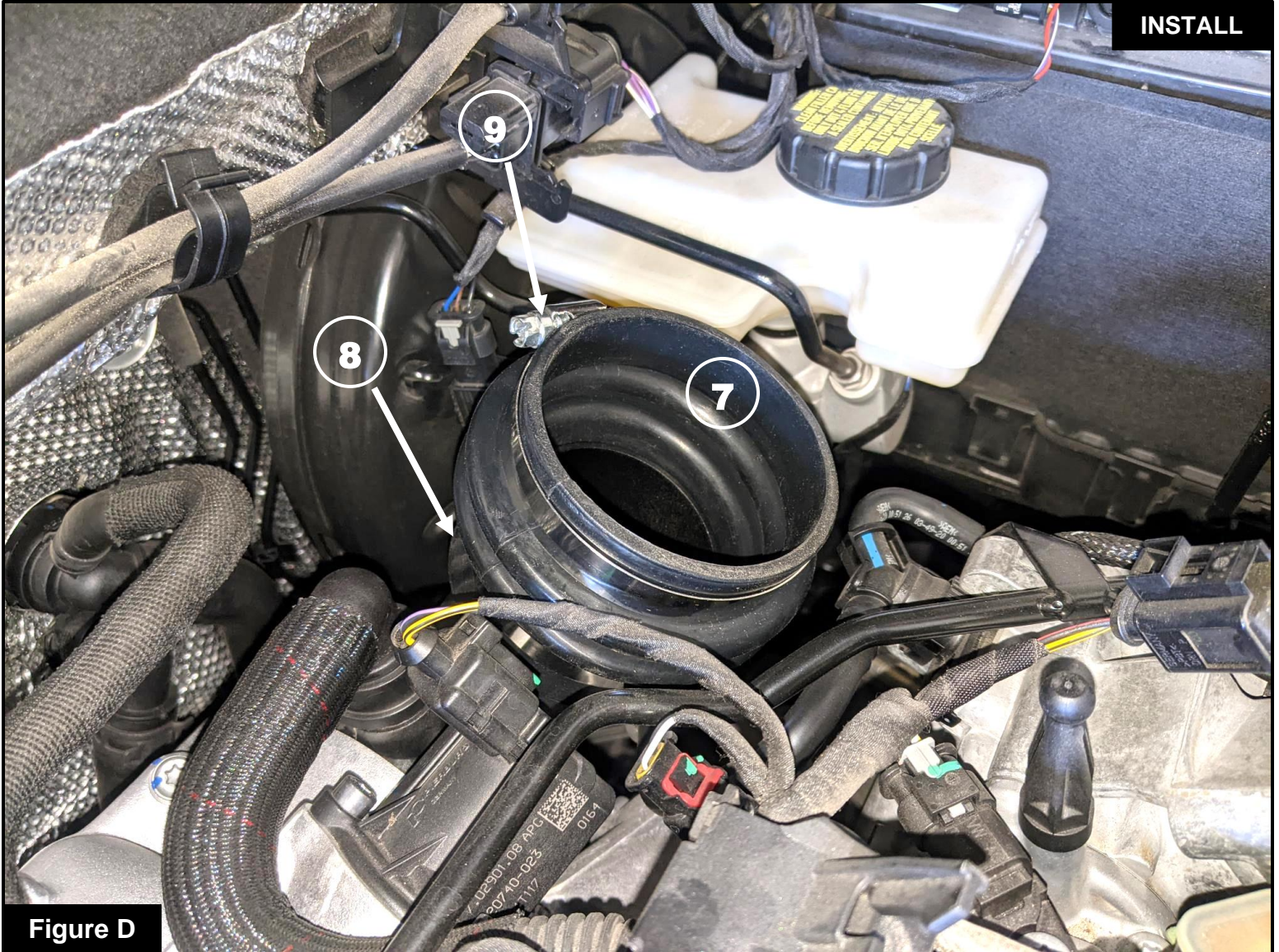

Figure C

**Refer to Figure C for Steps 7-8**

Step 7: Remove the factory air filter (5) from the vehicle.

Step 8: Remove the factory grate (6) from the bottom of the air box by lifting upwards on it.

**Figure D****Refer to Figure D for Steps 9-10**

Step 9: Install the supplied reducer coupling (7) and #048 clamp (8) with the smaller side on the turbo inlet and tighten using an 8mm nut driver.

Step 10: Place the second #048 clamp (9) loosely around the open end of the coupler.

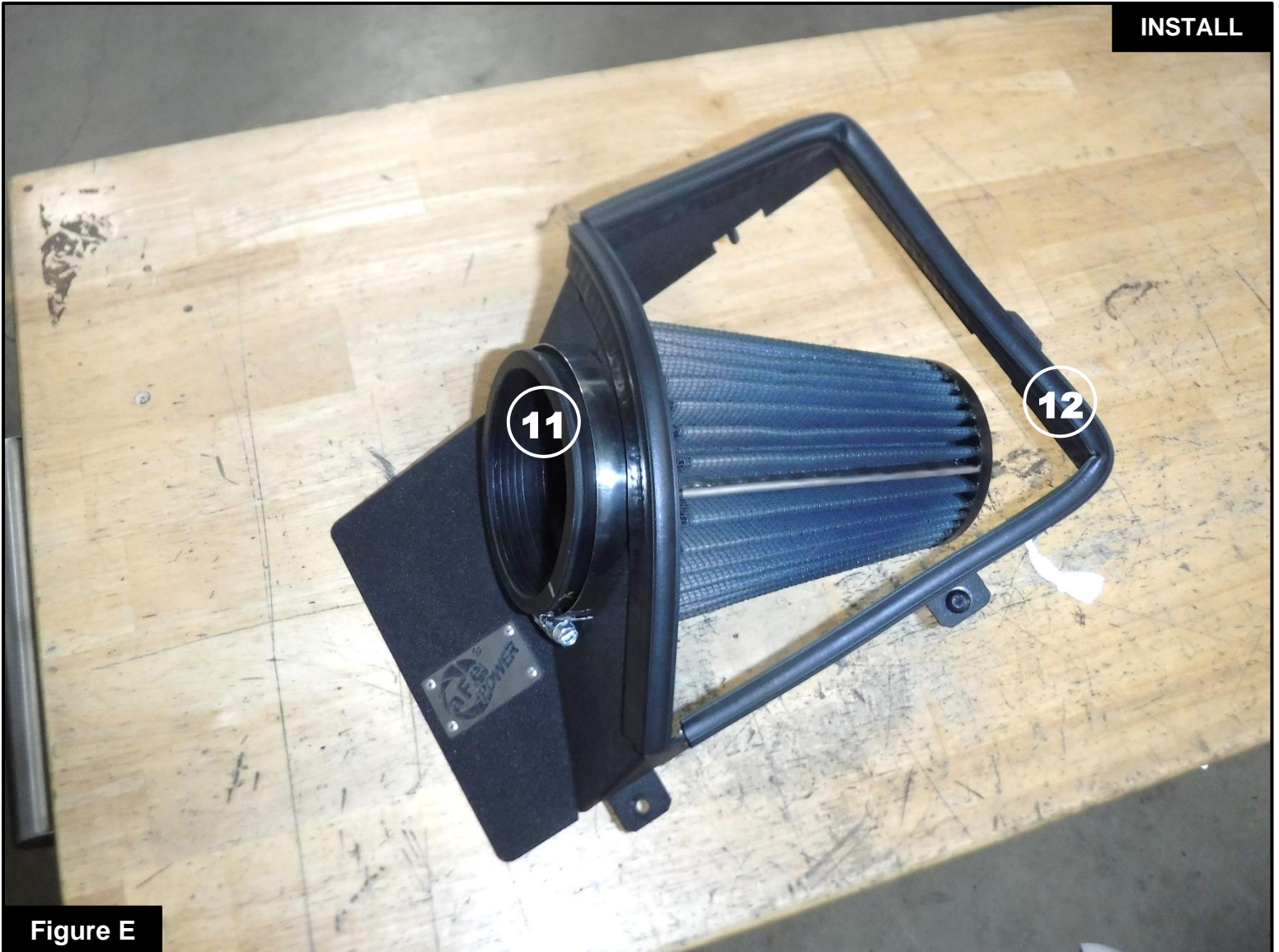
**Figure E****Refer to Figure E for Steps 11-12**

Step 11: Install your aFe POWER air filter into the filter housing (11) by firmly pressing it into the opening until the small tabs are locked on the outside. Leave the clamp loose on the filter opening.

Step 12: Install the seal trim around the top edge of the filter housing (12)

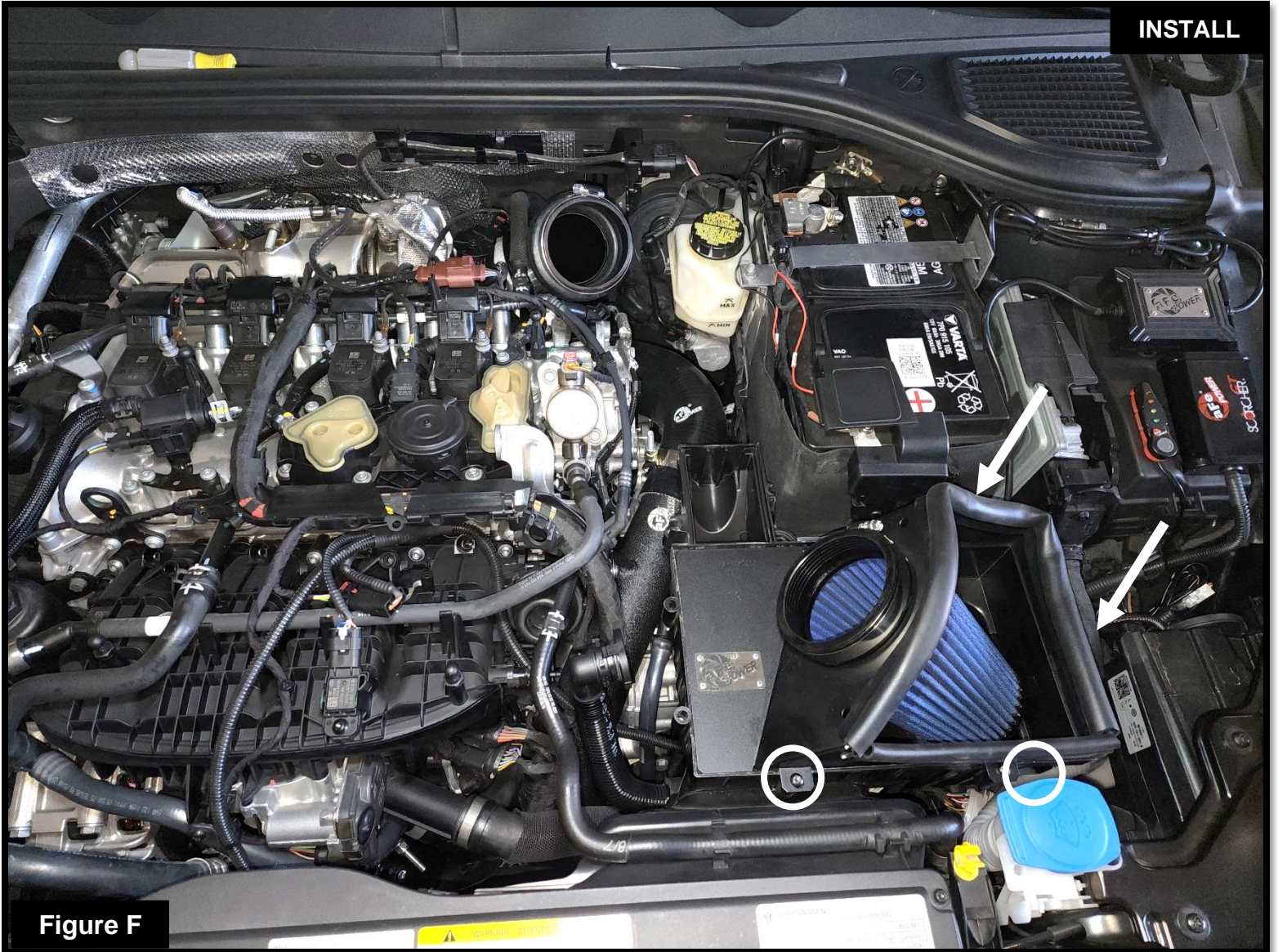

**Figure F****Refer to Figure F for Step 13**

Step 13: Install your aFe POWER air filter and housing onto the the lower half of the factory air box. Secure the aFe POWER filter housing to the factory lower air box using four of the factory screws from the air box lid.

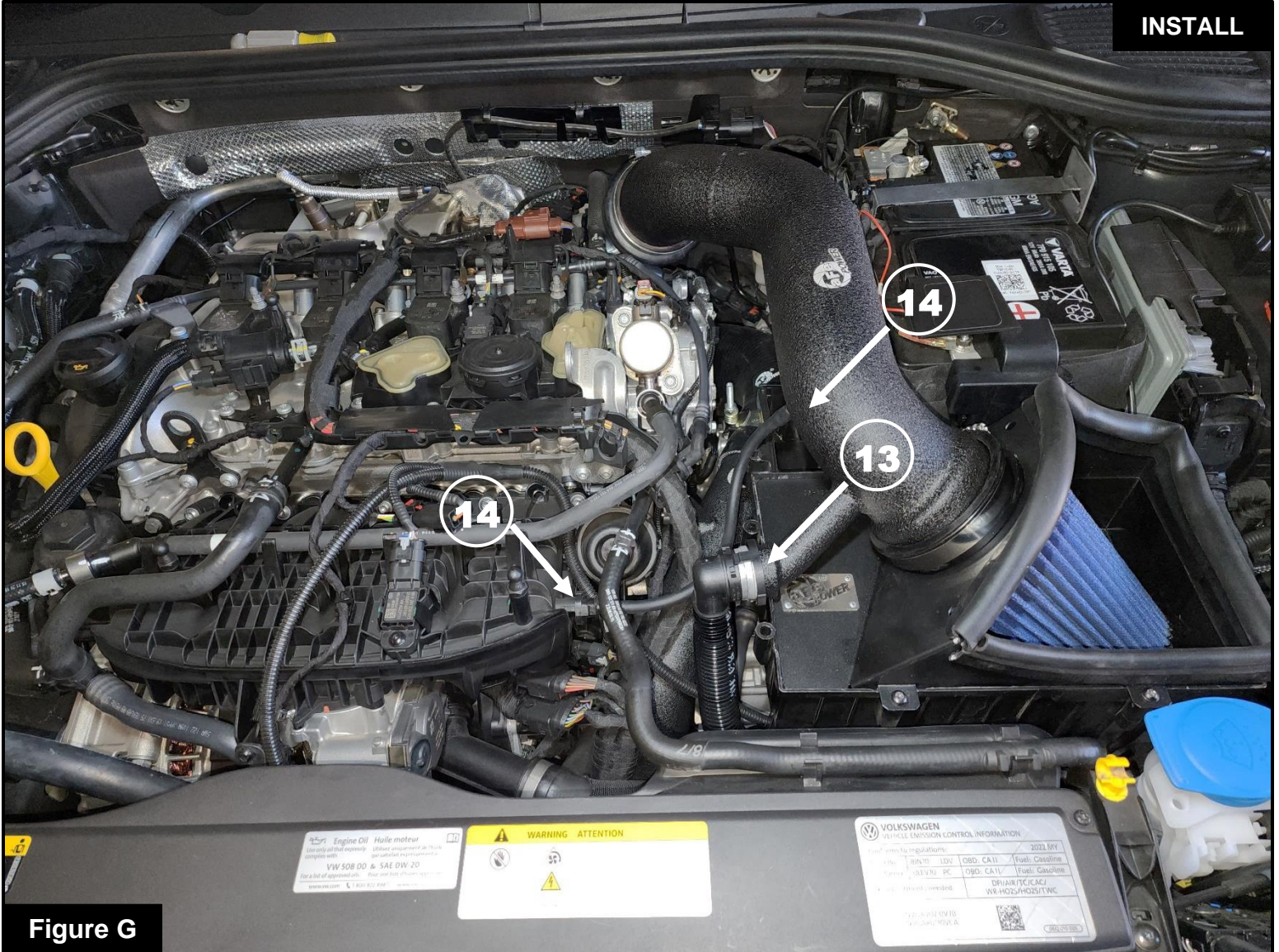

Figure G

**Refer to Figure G for Steps 14-16**

Step 14: Install your aFe POWER intake tube first into the opening on the air filter, then rotate it downwards into the open end of the coupler at the turbo inlet. Use an 8mm nut driver to tighten all clamps.

Step 15: Reconnect the smog pump hose (13) to the fitting on the side of the aFe POWER intake tube.

Step 16: Install the supplied vacuum hose (14) from the engine to the barbed fitting on your aFe POWER intake tube.



Figure H

**Refer to Figure H for Steps 17-18**

Step 17: Reinstall your engine cover, if equipped.

Step 18: Check that all components are tight and secure. Your installation is now complete. Thank you for choosing aFe POWER!

**NOTE: Check all clamps, and connectors are secure after 100-200 miles**



***advanced FLOW engineering, inc.***

252 Granite Street Corona, CA 92879  
TEL: 951.493.7100 • TECH: 951.493.7185  
E-Mail: Tech@aFepower.com

52-10018X  
12/9/2022 KF