

**advanced FLOW engineering**

**Instruction Manual** P/N: 51-12732 & 54-12732

---

Make: **Chevrolet** Model: **Corvette Z06 (C6)** Year: **2007-2013** Engine: **V8-7.0L**



- Please read the entire instruction manual before proceeding.
- Ensure all components listed are present.
- If you are missing any of the components, call customer support at 951-493-7100.
- Ensure you have all necessary tools before proceeding.
- Do not attempt to work on your vehicle when the engine is hot.
- Disconnect the negative battery terminal before proceeding.
- Retain factory parts for future use.

Label	Qty.	Description	Part Number
A1	1	Air Filter (Pro DRY S)	21-90087
A2	1	Air Filter (Pro 5R)	24-90087
B	1	Tube	05-12732B1
C	1	Cover	05-12732B2
D	2	Screw, Torx: M4 x .7 x 8mm	03-50491
E	2	Clamp, T-Bolt (3/-3/4-4-1/16)	03-50262
F	1	Threadlocker	03-50162
G	1	Vent Fitting	03-50402
H	1	Coupling, Silicone Hump	05-01332
I	2	Screw, M6x1x12	03-50102
J	2	Washer, Flat	03-50070
K	2	Seal, Trim; 7/16" (5")	05-00072
L	1	Seal, Trim: Small (26")	05-00149

Tools needed: 7mm, 8mm, 10mm and 7/16 Socket or nut driver, Ratchet and extension, flat head screw driver & razor blade, torx T20 driver.

Note: Legal in California for use on race vehicles only. The use of this device on vehicles used on public streets or highways is strictly prohibited in California and others states that have adopted California emission regulations.

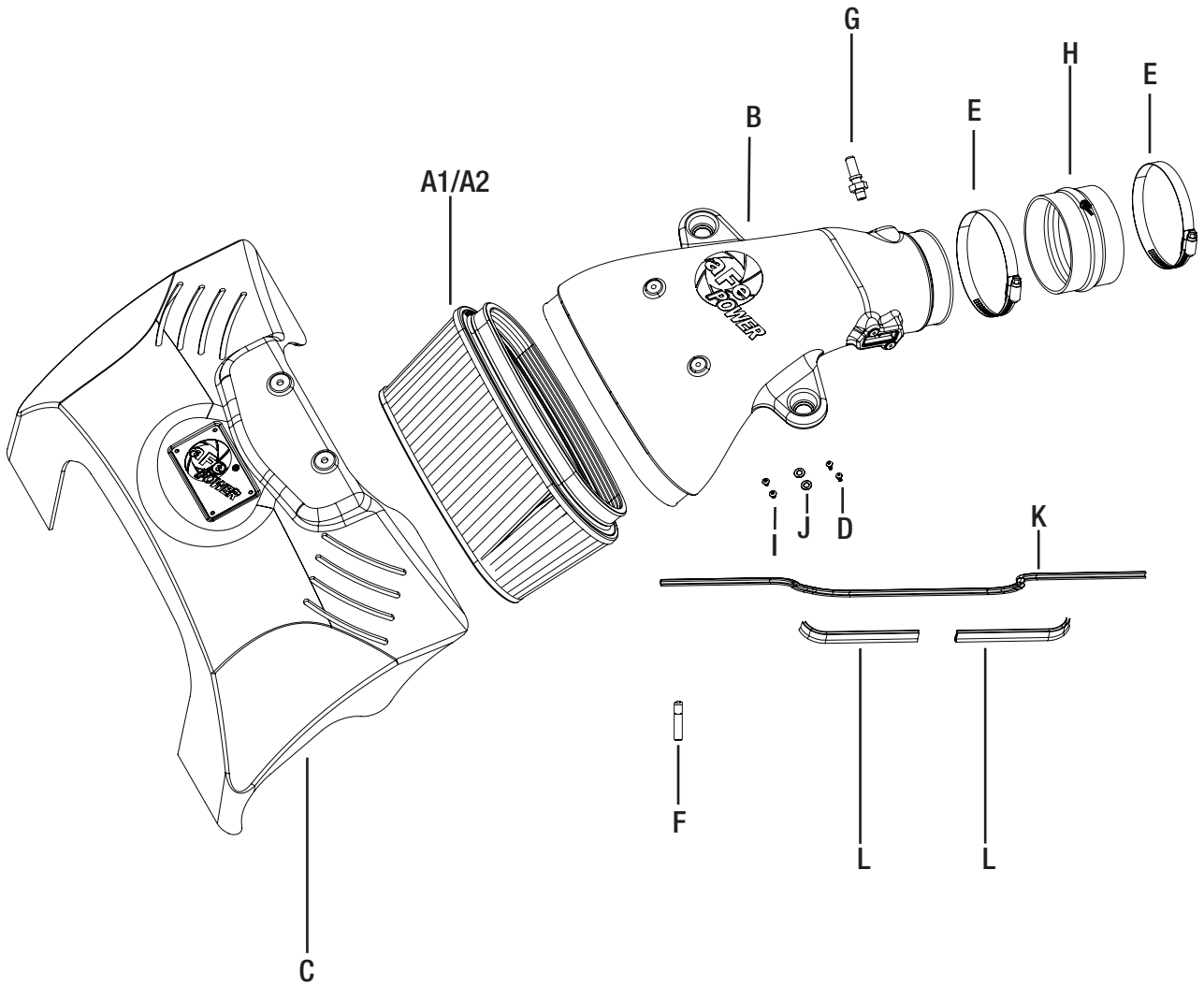

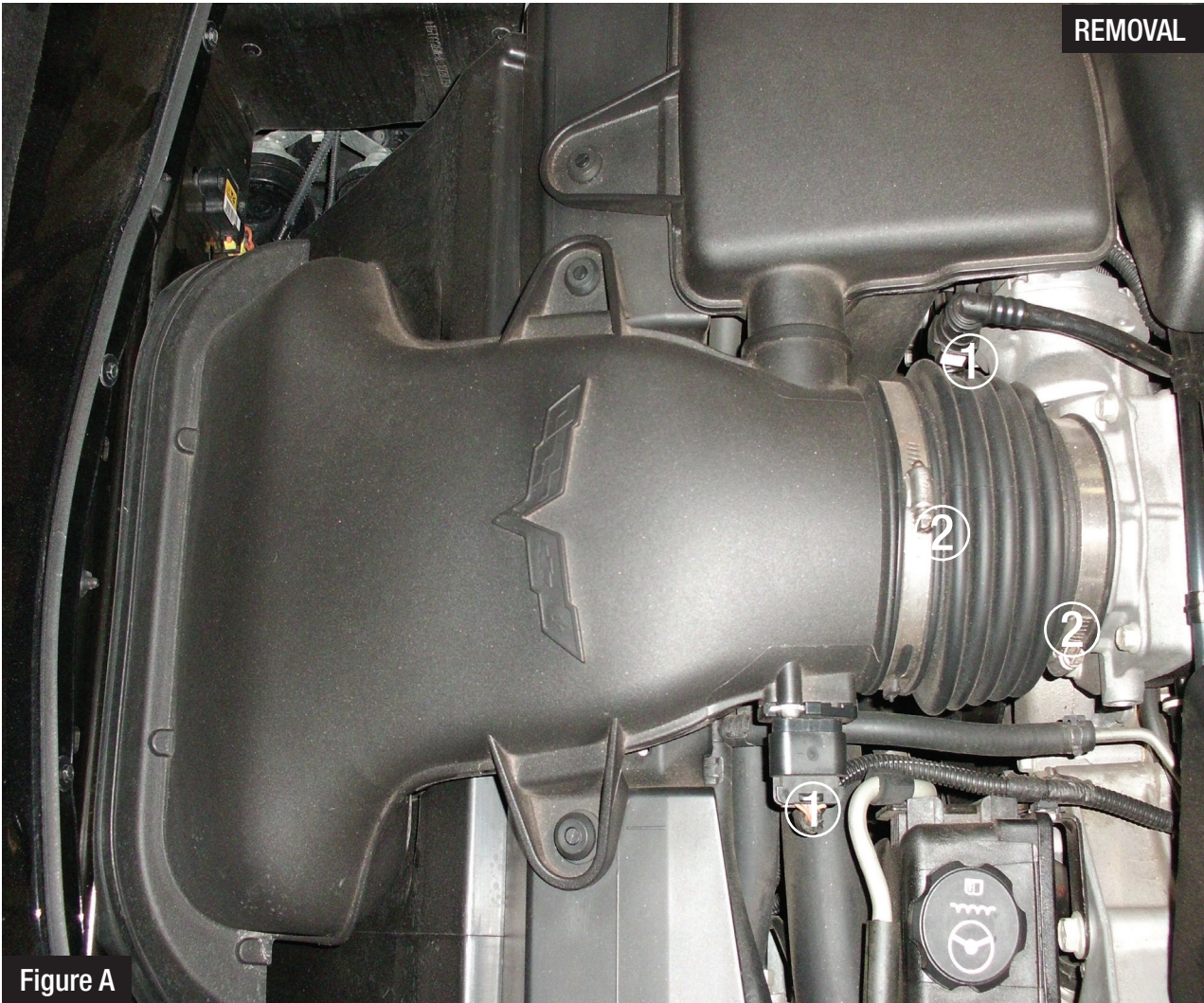
**Figure A****Refer to Figure A for Steps 1-2**

Step 1: Disconnect MAF sensor harness & vacuum line ①.

Step 2: Loosen clamps with 8mm (5/16") socket ②.

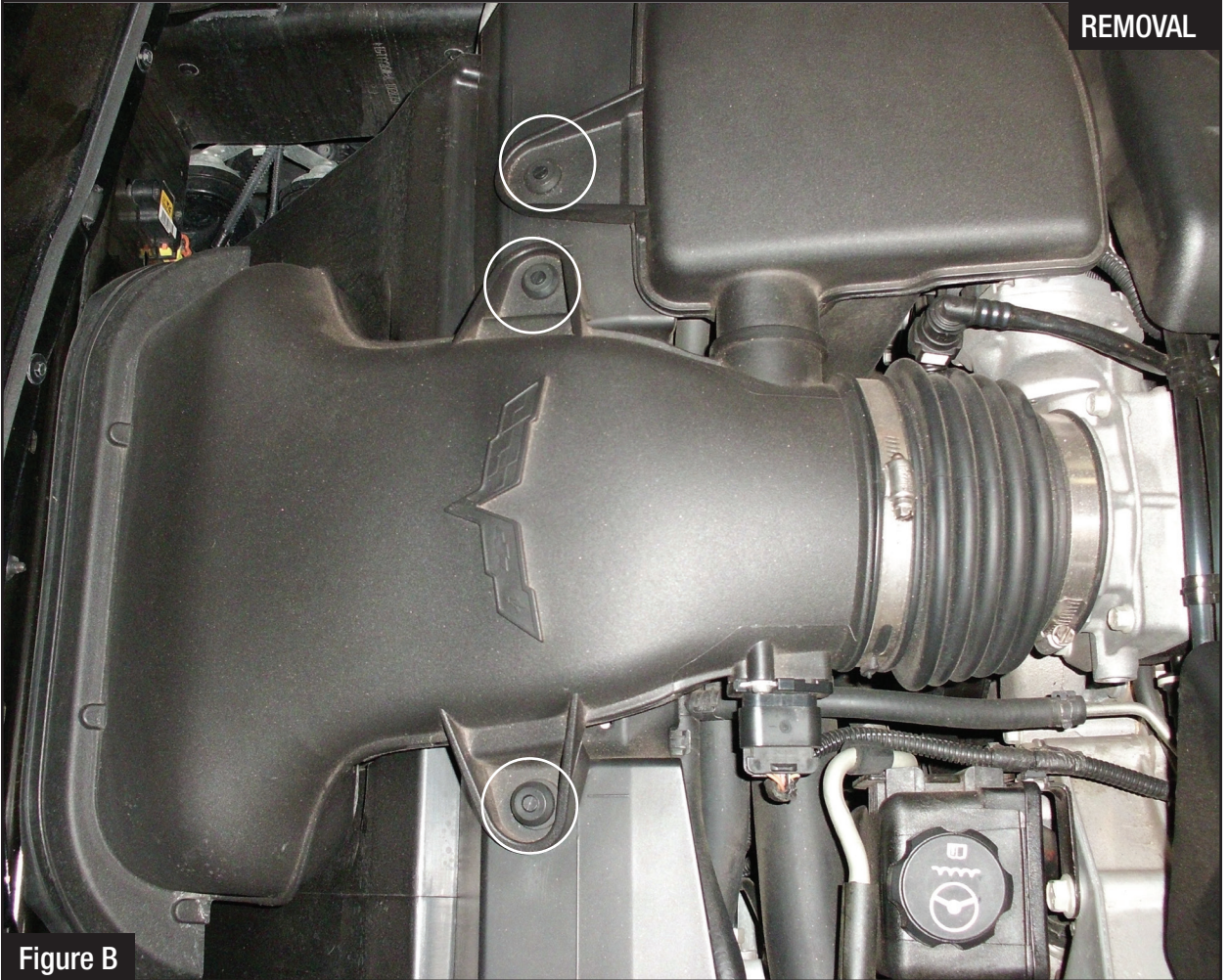

Figure B

**Refer to Figure B for Step 3**

Step 3: Lift up the airbox carefully to detach from the 3 OE grommets. Take OE air box out of vehicle.

REMOVAL



Figure C

Figure D

**Refer to Figure C for Step 4 & Figure D for Step 5**

Step 4: Remove the MAF sensor from the OE tube, and install the MAF sensor on the aFe tube using the supplied M4 T20 torx screws.

Step 5: Install supplied NPT Fitting into aFe tube, using supplied threadlocker.



Figure E

**Refer to Figure E for Step 6**

Step 6: Install Air Filter on the aFe tube with supplied clamp, and tighten with 8mm (5/16") socket.



Figure G



Figure F

INSTALL

**Refer to Figure F & Figure G for Steps 7-8**

Step 7: Transfer two OE mounting grommets from OE tube onto the aFe tube.

Step 8: Install the supplied coupling with two clamps onto the vehicle's throttle body.

Do not tighten clamps yet.

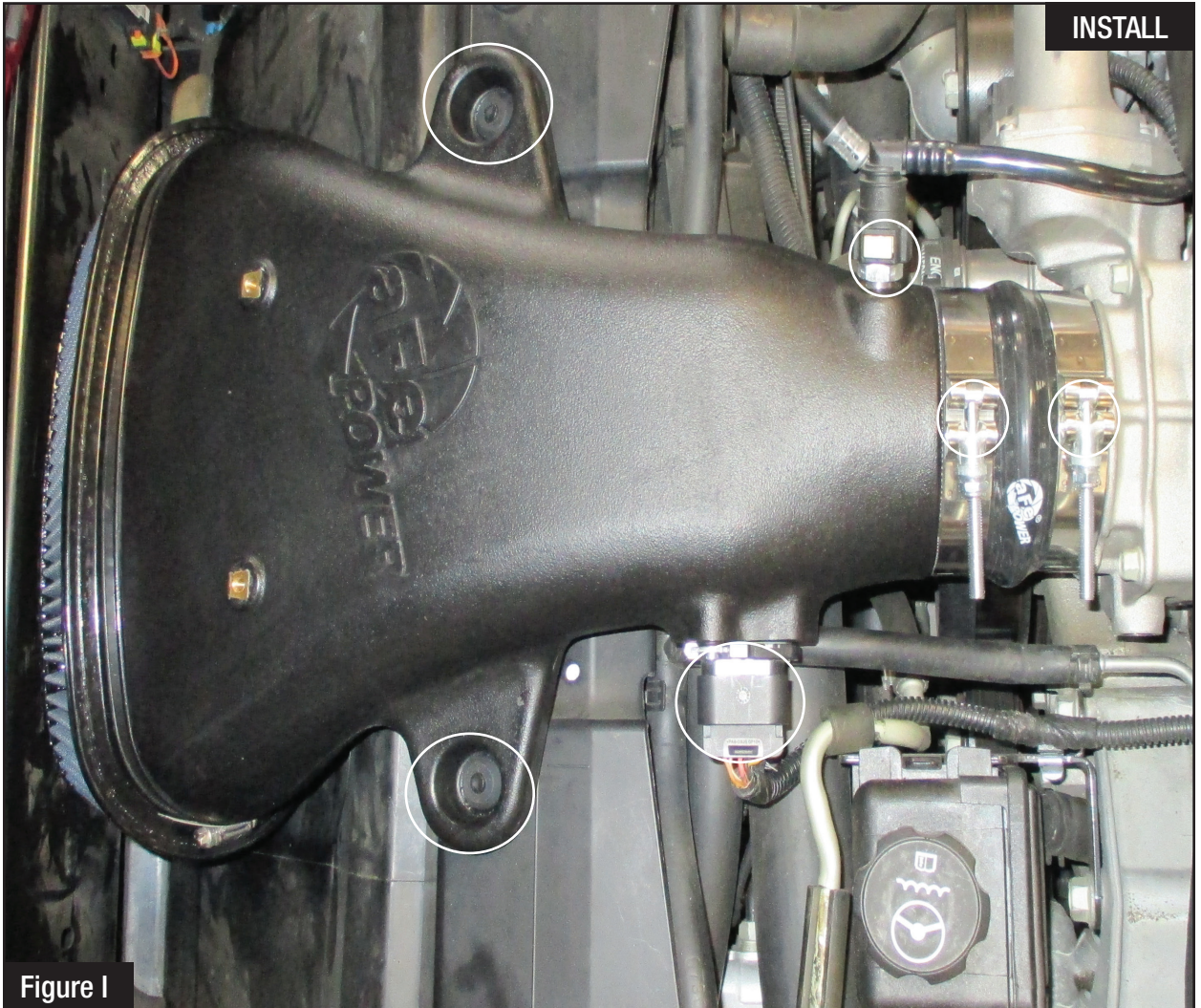



Figure H

**Refer to Figure H for Step 9**

Step 9: Place the 7/16" seal trim along the short edges of the intake cover (3). Place the 1/16" seal trim along the longer edge, facing the engine, of the intake cover (4).

**Figure I****Refer to Figure I for Steps 10-13**

Step 10: Install the aFe tube into the vehicle.

Step 11: Align the tube correctly by pushing grommets firmly onto mounting locations.

You may need to open the T-bolt clamps by removing the nut completely.

Then place the clamp around the coupling and tighten it by re-installing the nut. Tighten all clamps.

Step 12: Reconnect the MAF sensor.

Step 13: Connect the vent hose onto the aluminum fitting.

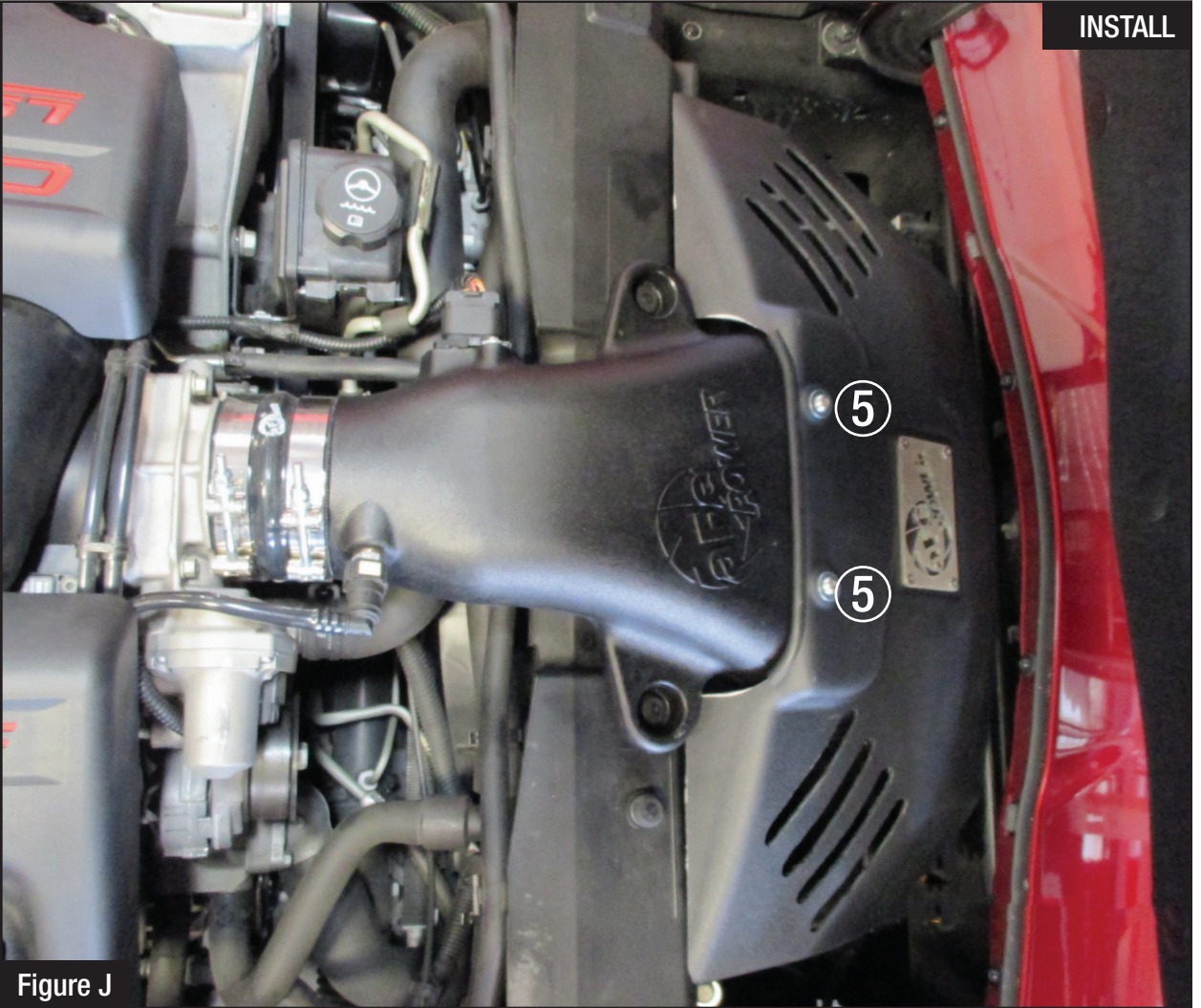

Figure J

**Refer to Figure J for Steps 14-15**

Step 14: With the aFe intake tube installed, install the aFe cover over the intake using the supplied M6 screws and washers (5).

Step 15: Make sure all clamps and connections are secure. Your installation is now complete. Thank you for choosing aFe Power!

NOTE: Verify all connections are secure 100-200 miles after installation.



This Page left blank intentionally.

This Page left blank intentionally.



Pro DRY S Air Filter



P/N: 21-90087

Pro 5R Air Filter



P/N: 24-90087

Pro DRY S Restore Kit



P/N: 90-59999

Blue Squeeze Restore Kit



P/N: 90-50501

aFe Gear



P/N: 46-30382 (M)  
46-30383 (L)  
46-30384 (XL)

aFe Gloves



P/N: 49-10149

Camber Kit

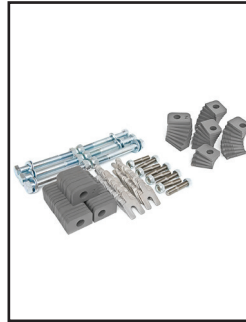

P/N: 450-401010-A

Transmission Mounts

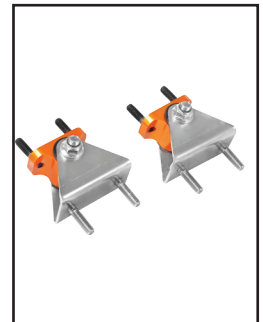

P/N: 450-401008-N

Sway Bars

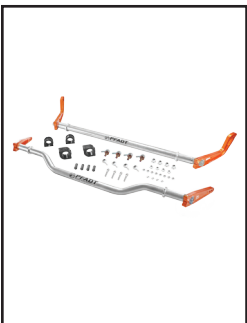

P/N: AC-440401005N

Lowering Kit



P/N: AC-410401001A

Coilovers



P/N: AC-430401001N

Sprint Booster



P/N: 77-14004 (M/T)  
77-14005 (A/T)

To purchase any of the items above, view airflow charts, dyno graphs, photos, and video; please go to [aFepower.com](http://aFepower.com).

# Warranty

## General Terms:

- aFe warrants their products to be free from manufacturer's defects due to workmanship and material.
- This warranty applies only to the original purchaser of the product and is nontransferable.
- Proof of purchase of the aFe product is required for all warranty claims.
- Warranty is valid provided aFe instructions for installation and/or cleaning were properly followed.
- Proper maintenance with regular inspections of product is required to insure warranty coverage.
- Damage due to improper installation, abuse, unauthorized repair or alteration is not warranted.
- Incidental or consequential damages or cost, including installation and removal of part, incurred due to failure of aFe product is not covered under this warranty.
- All warranty is limited to the repair and/or replacement of the aFe part. To request Return Goods Authorization ("RGA"), email [RGA@afepower.com](mailto:RGA@afepower.com) or call (951)493-7100. Upon receipt of the RGA, you must return the product to the address provided in the RGA, freight prepaid and accompanied with a dated proof of purchase and the RGA. Upon receipt of the defective product and upon verification of proof of purchase, aFe will either repair or replace the defective product within a reasonable time, not to exceed thirty days.

<b>Product Category</b>	<b>P/N Prefix</b>	<b>Warranty duration</b>
Direct OE Replacement Filters	10, 11, 30, 31, 71, 73	Life of the vehicle
Racing Filters	18	1 year
Universal	21, 24, 72	2 years
Air Intake Systems	50, 51, 54, 55, 75	2 years
Exhaust Systems	49	2 years
Intercoolers & Intercooler Tubes	46-2	2 years
Intake Manifolds	46-1	2 years
Differential Cover	46-7	Life of the vehicle
Exhaust Manifolds	46	2 years
Throttle Body Spacers	46-3	2 years
Fluid Filters	44	90 days
Pre-Filters	28	2 years
Heavy Duty OE Replacement	70	2 years
PowerSports OE Replacement	81, 87	2 years
PowerSports Intake Systems	85	2 years

No other warranty expressed or implied applies nor is any person or advanced FLOW engineering authorized to assume any other warranty. Some States do not allow the exclusion or limitation of incidental or consequential damages or do not allow limitations on how long an implied warranty lasts, so the above limitations or exclusions may not apply to you. This warranty gives you specific legal rights, and you may also have other rights which vary from State to State.

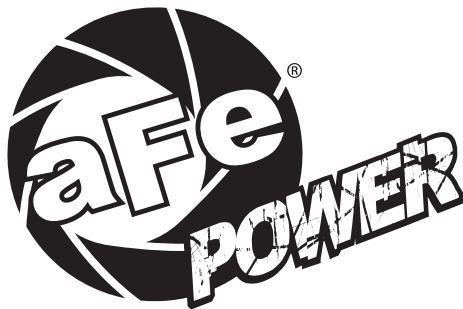

**advanced FLOW engineering, inc.**  
252 Granite Street Corona, CA 92879  
TEL: 951.493.7155 • TECH: 951.493.7100  
E-Mail: [Tech@aFepower.com](mailto:Tech@aFepower.com)