

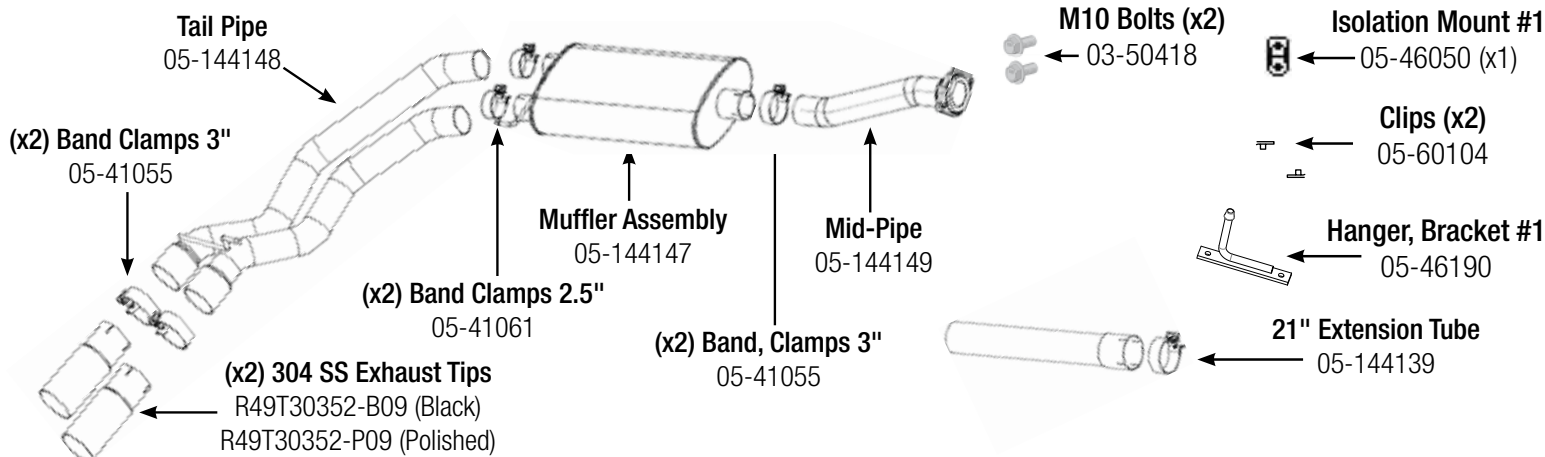

INSTALLATION INSTRUCTIONS

MAKE: Ford
 MODEL: F-150 & EcoBoost
 YEAR: 2015-2020
 ENGINE: V6-2.7L (tt)/3.5L (tt)/V8-5.0L
 WHEELBASE: EC/LB (163") 8 ft. Bed, CC/SB (145") 5.5 ft. Bed, CC/LB (157") 6.5' ft. Bed, EC/SB (145") 8 ft. Bed

Cat-Back
409 Stainless Steel
49-43081-B (Black Tips)
49-43081-P (Polished Tips)



Caution: Allow time for your vehicle to cool down prior to installation. When working on or under your vehicle proceed with caution. Exhaust systems reach high temperatures and may cause serious burns. Wear protective safety equipment; eye goggles and gloves to ensure a safe installation.

Step 1: (Read Instructions prior to installation) properly support your stock exhaust system, and remove your stock exhaust up to the catalytic converter from the rear of your truck, working your way forward. Take caution not to damage the factory hardware and isolation mounts. (It is recommended to not fully tighten the clamps until the entire system has been installed.)

Step 2: For faster installation spread the pieces of the exhaust alongside of your vehicle according to the diagram shown.

Step 3: Start by placing clip-on nuts into frame, as shown on **(figure A)**. The clip-on nuts should slide right in hassle free.

Step 4: Now that the clip-on nuts are in place, place Hanger bracket #1 over clip-on nuts and tighten bracket down securely with the proper bolts provided.

Step 5: Attach OE hanger bracket on inside of the frame on the first set of holes as shown in the **(figure B)**.

Step 6: Install the front pipe using the provided bolts and nuts, leaving the Flange bolts slightly loose to move for adjustment.

Step 7: Using a Jack/Stand for support, slide the muffler assembly in place using provided 3" clamps and OE isolation mount for the CC/SB 145" WB and the EC/ 6.5 ft. bed. For the 163" WB EC/LB 8ft bed install 21" extension pipe. For the 157" WB CC/LB 6.5 ft. bed Trim extension to 15".

Step 8: Place provided 2.5" band clamps over the muffler exits and install the tailpipe. Insert the provided rubber isolation mount over the tail-pipe hanger, slide it onto hanger bracket #2

Step 9: Align and straighten exhaust and begin to tighten down system beginning at the front and working your way back.

Step 10: Place tips into desired position, but do not fully tighten them!

Step 11: Align and straighten exhaust and begin to tighten down system beginning at the front flange and working your way back and ending at the tip location.

Step 12: Congratulations, Your system is now complete and fully installed! It is recommended to re-tighten all clamps and bolts after 50-100 miles.

(Figure A.)



(Figure B.)



- aFe recommends that the tailpipe be at least 1/2"-1" away from any body panels to avoid heat related body damage. **Tighten and secure.**
- It is normal for your exhaust system to emit smoke for the first few minutes upon initial start-up.