



Installation instructions

Akrapovič Exhaust System:

Slip-On

for the

Porsche 911 Carrera (type 991)

Porsche 911 Carrera S (type 991)

Porsche 911 Carrera 4 (type 991)

Porsche 911 Carrera 4S (type 991)

ENGLISH

Version 1.0

12/2017



www.akrapovic.com



Installation instructions

Akrapovič Exhaust System:

Slip-On

for the

Porsche 911 Carrera (type 991)

Porsche 911 Carrera S (type 991)

Porsche 911 Carrera 4 (type 991)

Porsche 911 Carrera 4S (type 991)

ENGLISH

Version 1.0

12/2017

www.akrapovic.com

Congratulations on purchasing the Akrapovič exhaust system. The Akrapovič exhaust system is a product of Akrapovič d.d., Malo Hudo 8a, 1295 Ivančna Gorica, Slovenia ("Akrapovič").

Please read this entire installation manual carefully prior to installing and using the Akrapovič exhaust system.

Akrapovič exhaust system should only be installed by persons skilled in car exhaust system installation and performance. The instructions provided in this manual should be followed to ensure proper installation and safe use of the Akrapovič exhaust system. Akrapovič and/or its partners shall not be held liable for any damage or personal injury (including direct, indirect, or consequential damage) sustained as a result of improper installation of the Akrapovič exhaust system or its use and maintenance contrary to the instructions and warnings contained herein.

If you have any questions regarding the installation and/or proper use of the Akrapovič exhaust system or this manual, please contact your local Akrapovič partner.

For more information on the Akrapovič exhaust systems, see the official Akrapovič website at: <http://www.akrapovic.com>

GENERAL INFORMATION

Your safety is our number one priority. Please drive your car responsibly, safely and always obey local traffic rules.

All statements made with regard to the exhaust system's compliance are made in respect of the exhaust system "as is". Any modifications of the Akrapovič exhaust system or its improper installation, use or maintenance that is not in accordance with this Installation manual, may result in severe damage to the exhaust system and/ or engine, as well as personal injury, and may affect the exhaust system's compliance with the legal requirements, such as exhaust system's air and/ or noise emissions (as an example, the car may not be suitable for use on public roads any longer), as well as warranty coverage.

The exhaust system may only be used in accordance with relevant laws and regulations, including state and federal, where applicable.

Damage caused by improper installation, use and maintenance of the Akrapovič exhaust system is not covered by the Akrapovič warranty. Please refer to the enclosed warranty with regard to the terms of our warranty.

Technical specifications of Akrapovič exhaust systems and related products are subject to change without notice.

COPYRIGHT AND OTHER RIGHTS NOTICE

The Akrapovič trademark, including corporate logos and emblems, are subject to copyright as well as trademark rights of Akrapovič, its licensors, or third persons authorizing Akrapovič to use them.

Any reproduction, technical or other manipulation, translation, or other use of the copyright and/or trademark rights contained herein is prohibited without the explicit prior written consent of Akrapovič. The same especially applies to the entire contents of this manual and/or any of its parts, including but not limited to technical specifications, instructions, graphs, photographs, and so on included in this manual.

Akrapovič takes all copyright and other rights infringement cases under serious consideration. If you have any reason to believe that your exhaust system is not an original Akrapovič product, please contact our local partners or Akrapovič at info@akrapovic.com.

SAFETY AND COMPLIANCE WARNING, PLEASE READ CAREFULLY

BEFORE REMOVING THE STOCK EXHAUST SYSTEM AND BEGINNING THE INSTALLATION OF YOUR NEW AKRAPOVIČ EXHAUST, PLEASE MAKE SURE THAT ALL ITEMS LISTED BELOW ARE VERIFIED:

- This manual is specific to the car indicated on the cover page, for which it is designed. Installation procedures vary depending on the type of car. Please verify that the Akrapovič **exhaust system and this installation manual correspond to the type of your car.**
- The exhaust system can get extremely hot during and after it is used. Make sure not to touch the exhaust system until it is completely cool. **Allow the exhaust and engine to cool down before beginning installation.**
- Make sure the car is **securely positioned to prevent** damage to yourself and other, or the car.
- Please check the parts you received against the parts list available on our website (please use the QR code on the front page or look for “schematic view” in the respective product page on www.akrapovic.com). Make sure that you have **all the parts necessary for the installation** of your new Akrapovič exhaust system. If any of the parts is missing, please do not proceed with uninstalling your stock exhaust system/installing the Akrapovič exhaust system and contact the retailer where you purchased the Akrapovič exhaust system.
- Every exhaust system muffler has its unique serial number, which identifies the authenticity of the product. You can find the serial number on the muffler’s sleeve. Please refer to the **picture 1** below. Please verify that your exhaust system is an original Akrapovič product. If you have any doubts, please contact the reseller where you purchased the exhaust system or Akrapovič partners. This manual, any certificates and Akrapovič warranty apply to original products only.

GENERAL NOTE

Photographs and other illustrations in this manual are symbolic and are intended to help represent individual steps for proper installation and use, as well as for a general overview. The actual component parts of the Akrapovič exhaust system may not entirely correspond to the photographs and other illustrations.

Picture 1 - Serial Number Position

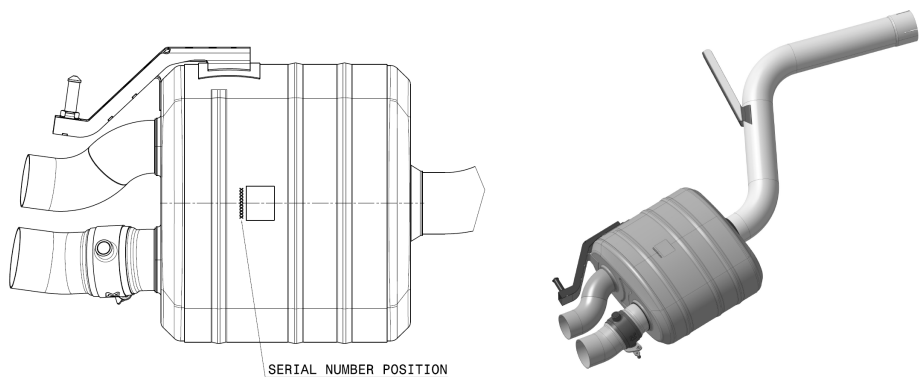

NOISE AND EMISSION WARNINGS

General warning

Because of the world-wide distribution of Akrapovič d.d. products, neither Akrapovič d.d. nor any of its subsidiaries make any representation that the exhaust system complies with the air and/or noise emissions laws, or labeling laws, of any jurisdiction. The purchasers are entirely responsible for informing themselves of the applicable laws where the products are to be used and to comply with those law.

Although legal compliance of Akrapovič products in a specific country should be determined by the user, you can find some basic guidance on compliance of your Akrapovič exhaust system with various legal requirements on the product-related part of our website (please use the QR code on the front page or look for the respective product page on www.akrapovic.com). For EC and ECE type approvals, please refer to the certificate enclosed to your product.

USA WARNING

Various U.S. states and the U.S. federal government have individual laws regulating the use of aftermarket exhaust parts and systems, especially as those parts and systems modify, remove, or replace original equipment catalysts. Please consult the appropriate laws in your area before installing any aftermarket part or system on your vehicle to ensure compliance with all applicable laws. Neither Akrapovic d.d. nor any of their subsidiaries or the sellers of the parts or systems make any representation that any of their parts or systems comply with any such laws.

CALIFORNIA WARNING

California laws prohibit the use of any aftermarket exhaust part or system that modifies, removes or replaces original equipment catalysts unless the California Air Resources Board has issued an Executive Order regarding such part or system or unless the part or system is exempted by being used only on racing vehicles on closed courses. Neither Akrapovic d.d. nor any of their subsidiaries make any representation that any of their parts or systems has received such an Executive Order or that any of their parts or systems conform with the racing vehicles exemption. The purchasers are entirely responsible for informing themselves of applicable California laws and to comply with those laws.

SYMBOLS

The following symbols are used throughout these installation instructions:



**TOOLS AND PROTECTIVE
EQUIPMENT REQUIRED**



TIGHTENING TORQUE



LUBRICATION



HAND TIGHTEN



INSTALLATION TIP



CAUTION OR IMPORTANT

USE BOLT SEALANT

Apply 3 to 4 small drops of bolt sealant onto the cleaned and degreased threads before tightening the bolts.

WARNING! Avoid contact with skin, eyes and mucous membranes. Do not inhale fumes. Keep out of reach of children.



USE ANTI-SEIZE LEAD-FREE COPPER PASTE (black tube)

Provides trouble-free and long-lasting protection against seizing, corrosion and rusting of bolts, threaded ends, nuts, joints, etc. Also protects against vibration, wear and impact. **WARNING! Avoid eye contact. Keep out of reach of children.**



USE ANTI-SEIZING GREASE (white tube)

Prevents seizing, corrosion and excessive wear between the titanium components of your exhaust system. **WARNING! Avoid eye contact. Keep out of reach of children.**



Tools & equipment

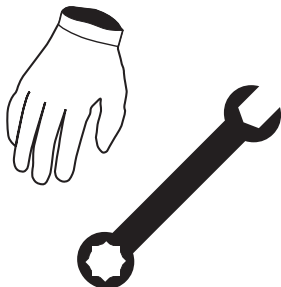

- T-handle hexagon 5 mm wrench
- T-handle hexagon 6 mm wrench
- T-handle 10 mm wrench
- T-handle 13 mm wrench
- Combination 13 mm wrench
- Bi-hex 13 mm socket
- T handle swivelling Torx E12
- Torx 30
- Small flat screwdriver
- Cutting nippers
- Heat gun

PARTS LIST

The following parts should be found in the box:

- Installation Manual
- Homologation certificate/ compliance documents if applicable
- Warranty
- Fitting material
- Muffler and pipes

Detailed list of parts can be found on the Akrapovič website (please use the QR code on the front page or look for "Schematic view" in the respective product page on www.akrapovic.com).

IMPORTANT: The car should be in the off position throughout the dismantling and installation process, as well as any other work done on the exhaust system!

REMOVAL OF STOCK EXHAUST SYSTEM:

The process of uninstalling the original exhaust system may vary depending on the existing exhaust system. Please follow the original exhaust system manufacturer's instructions for uninstalling the original exhaust system.

If you for any reason decide otherwise, please note that any information provided in this respect herein should be considered as general information provided for your convenience only. Akrapovič shall not assume any liability or responsibility with regard to uninstalling your existing exhaust system, warranty coverage of such exhaust system or vehicle or their further fitness for use.

In case your Akrapovič exhaust system may not be used on certain roads or under certain conditions, please keep the stock or other exhaust system that you can use in such circumstances legally.

REMOVAL OF STOCK EXHAUST SYSTEM:

Put the vehicle onto a car lift.

! **CAUTION:** make sure, that car lifting is safely and correctly done or you risk vehicle damage, injury or even death!

1. Carefully undo the marked trim panels and unscrew tail light bolts on both sides of the vehicle (Figure 1, 2).



Figure 1

! **IMPORTANT:** be careful not to damage the trim panels, tail lights or any other part of the vehicle during this procedure!



Figure 2

- Carefully remove both tail lights, disconnect the connectors and remove both tail lights off the vehicle (**Figure 3**).

! **IMPORTANT:** be careful not to damage the tail lights, connectors or any other part of the vehicle during this procedure!

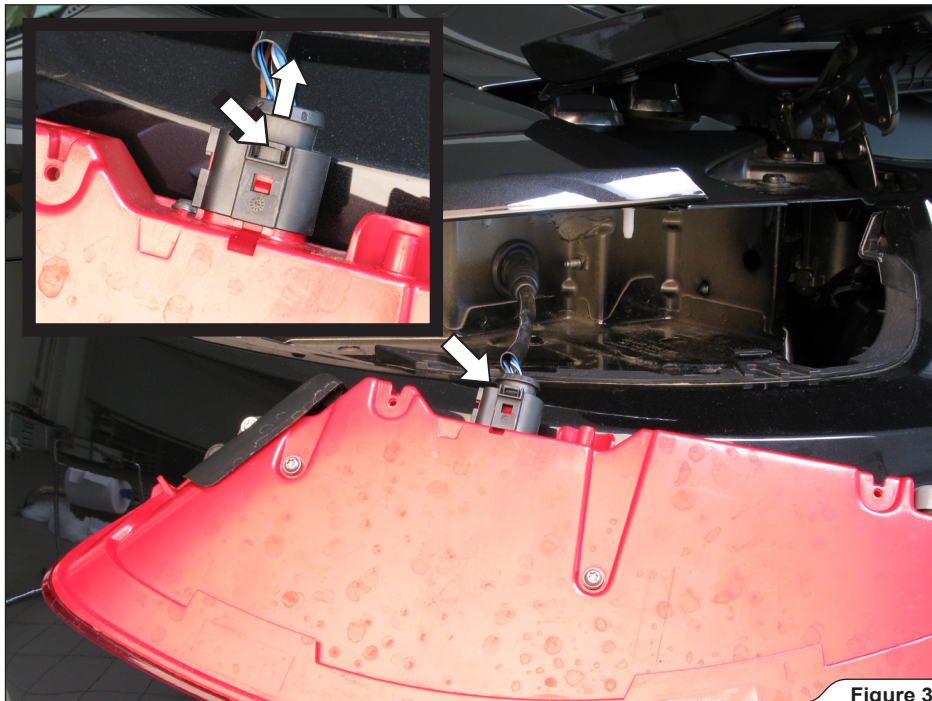

Figure 3

3. Unscrew the marked bolts on both sides of the vehicle and carefully **partially** remove the rear bumper (Figure 4, 5, 6).

! **IMPORTANT:** be careful not to damage or scratch any part of the vehicle during this procedure!



Figure 4



Figure 5

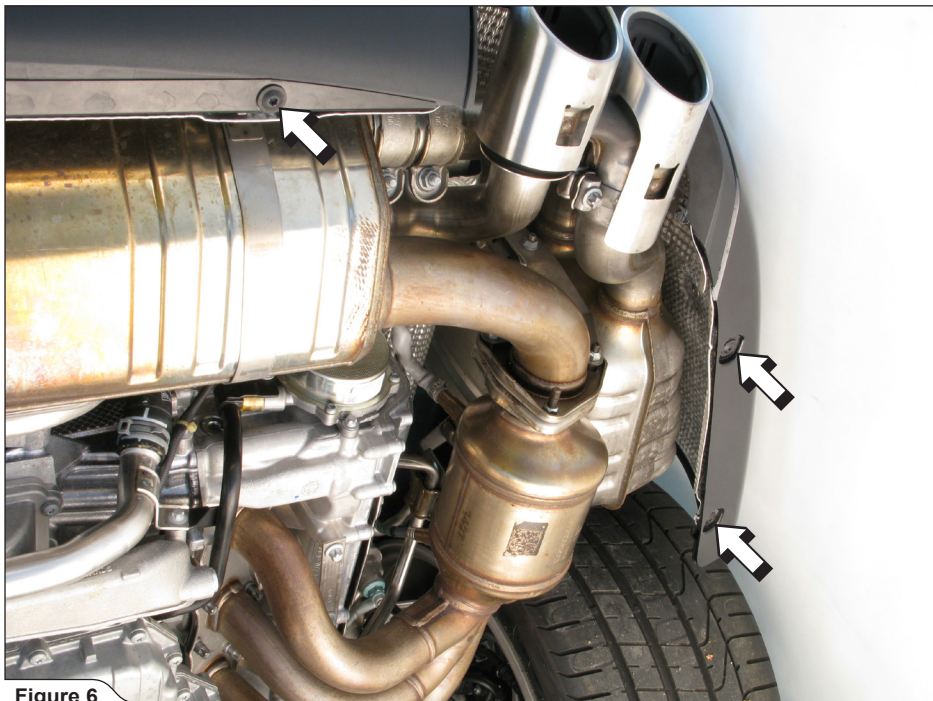

Figure 6

4. Disconnect the bumper's electrical connector and carefully remove the rear bumper off the vehicle (**Figure 7**).

! **IMPORTANT:** be careful not to damage the connector or any other part of the vehicle during this procedure!



Figure 7

5. Unscrew the marked nuts and bolts on both sides of the vehicle and carefully remove the side mufflers' heat shields (**Figure 8, 9**).

! **IMPORTANT:** be careful not to damage the heat shields or any other part of the vehicle during this procedure!



Figure 8

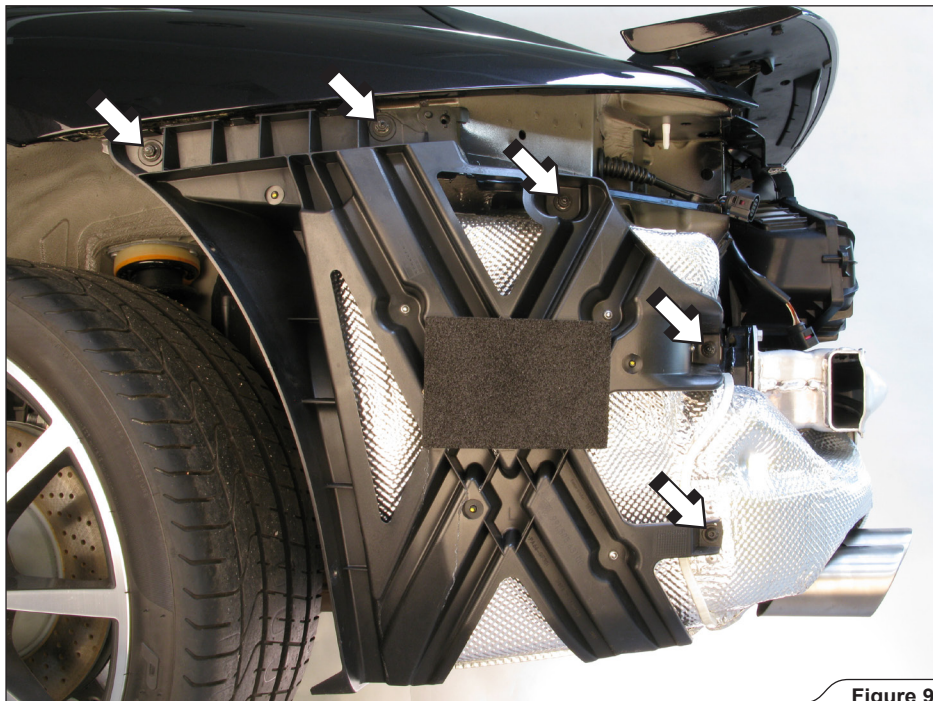

Figure 9

6. Unscrew the marked bolts on both sides of the vehicle and carefully remove the central muffler's heat shield (**Figure 10**).

! **IMPORTANT:** be careful not to damage the heat shield or any other part of the vehicle during this procedure!

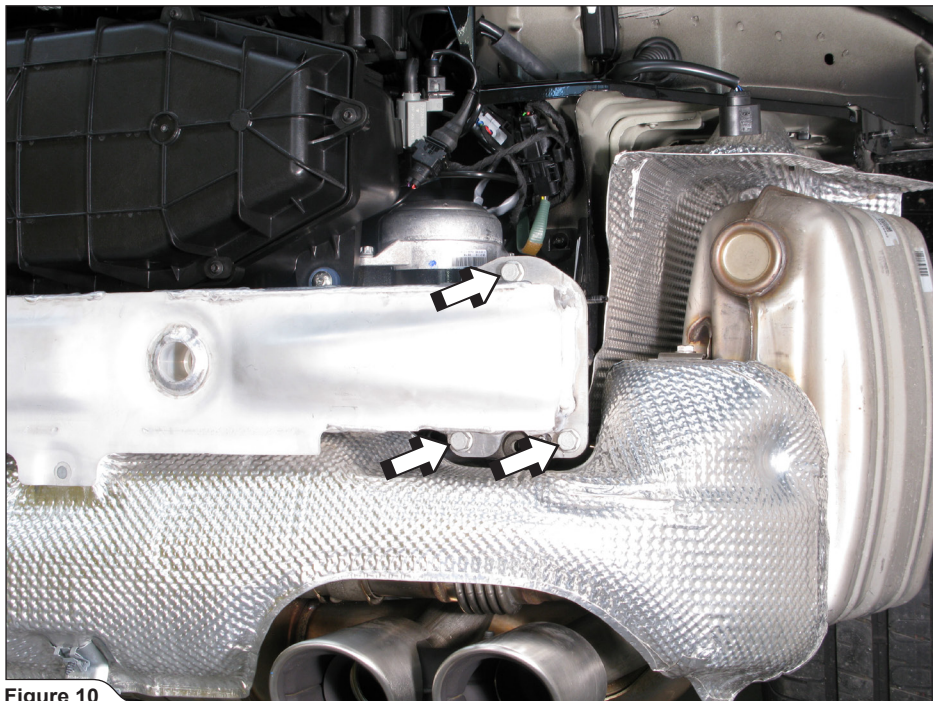

Figure 10

- Loosen the clamp and remove the tail pipes, loosen the double clamp and slide it out off the joint and unscrew the three marked nuts (**Figure 11**). Repeat the procedure on both sides of the vehicle.

! **IMPORTANT:** be careful not to damage any part of the vehicle during this procedure!

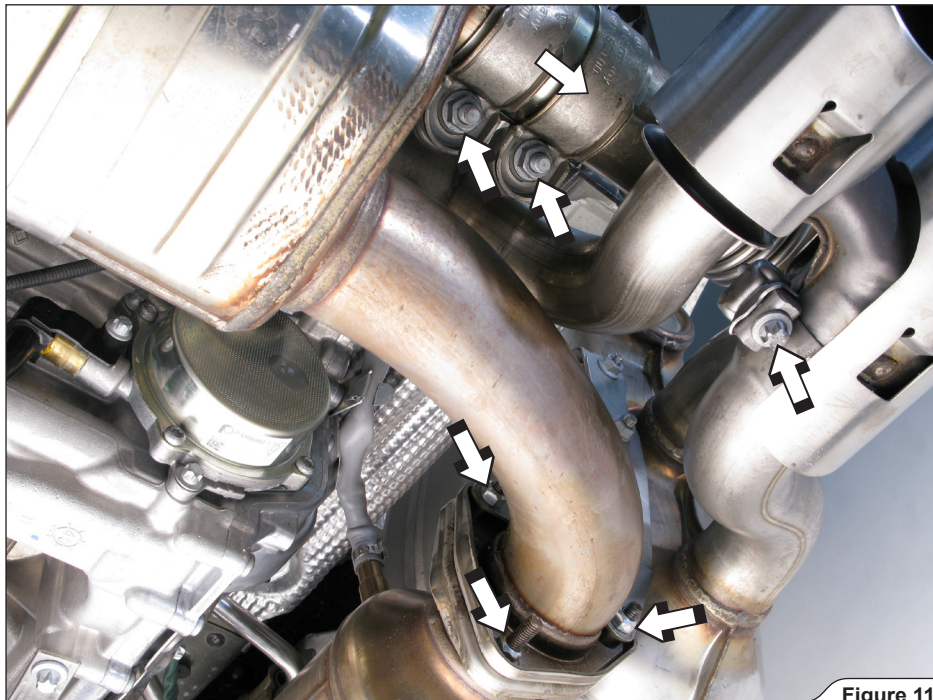

Figure 11

8. Unscrew the marked nuts on both sides of the vehicle and carefully remove the side mufflers off the vehicle (Figure 12).

! **CAUTION:** make sure not to injure yourself, or damage any part of the vehicle during this procedure!

! **CAUTION:** support the side mufflers during this procedure or you could injure yourself or damage the vehicle!



Figure 12

9. Carefully pull the vacuum hoses off the vacuum actuators (**Figure 13**).

! **CAUTION:** make sure not to injure yourself, or damage any part of the vehicle during this procedure!

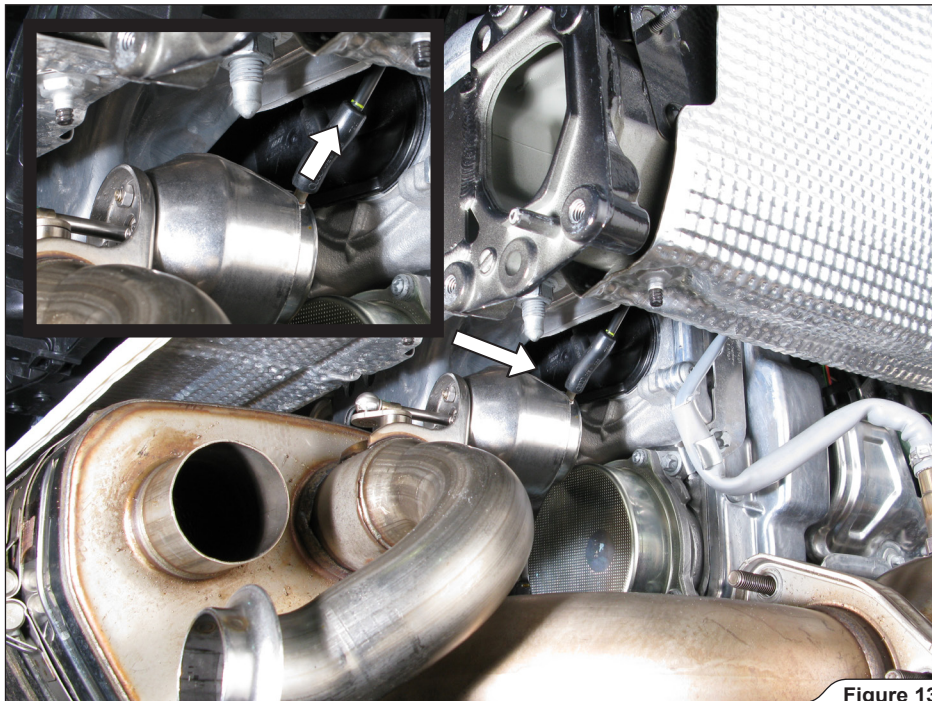

Figure 13

10. Loosen the header tubes' flange bolts on both sides of the engine (Figure 14).

! **IMPORTANT:** loosen the bolts only, do not fully unscrew them!

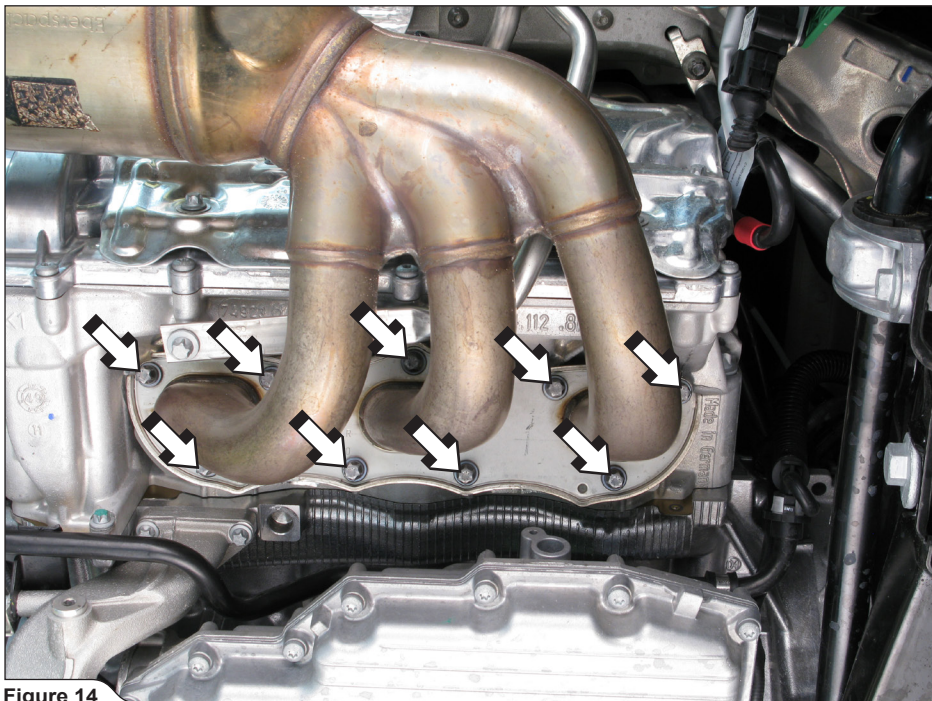

Figure 14

11. Unscrew the central muffler's clamps and carefully remove the muffler off the vehicle (**Figure 15**).

! **CAUTION:** make sure not to injure yourself, or damage any part of the vehicle during this procedure!

! **CAUTION:** support the muffler during this procedure or you could injure yourself or damage the vehicle!



Figure 15

INSTALLATION OF THE AKRAPOVIČ EXHAUST SYSTEM:

1. **For vehicles with original sports exhaust system only:** assemble the heat protection onto the rubber vacuum tubes using tape clamps; bind the other ends of the rubber tubes, using plastic Y distributor and clamps, as shown (Figure 16).

! IMPORTANT: do not tighten the tape clamps yet!

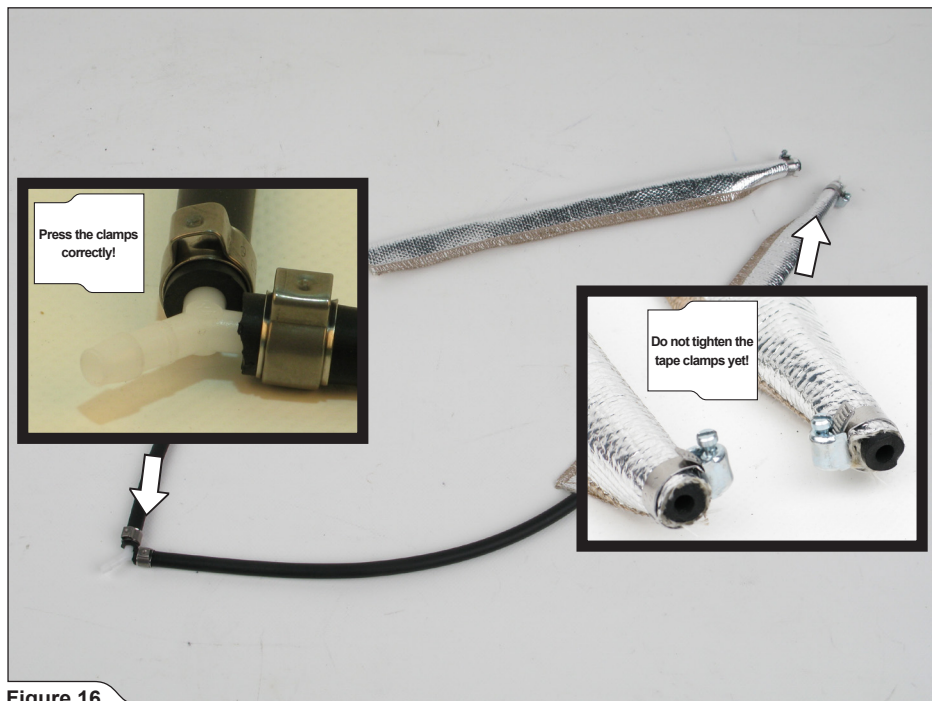

Figure 16

2. **For vehicles with non-sports original exhaust system only:** assemble the heat protection onto the rubber vacuum tubes using tape clamps; bind the other ends of the rubber tubes with pvc vacuum tubes, as shown (Figure 17).

! **IMPORTANT:** do not tighten the tape clamps yet!

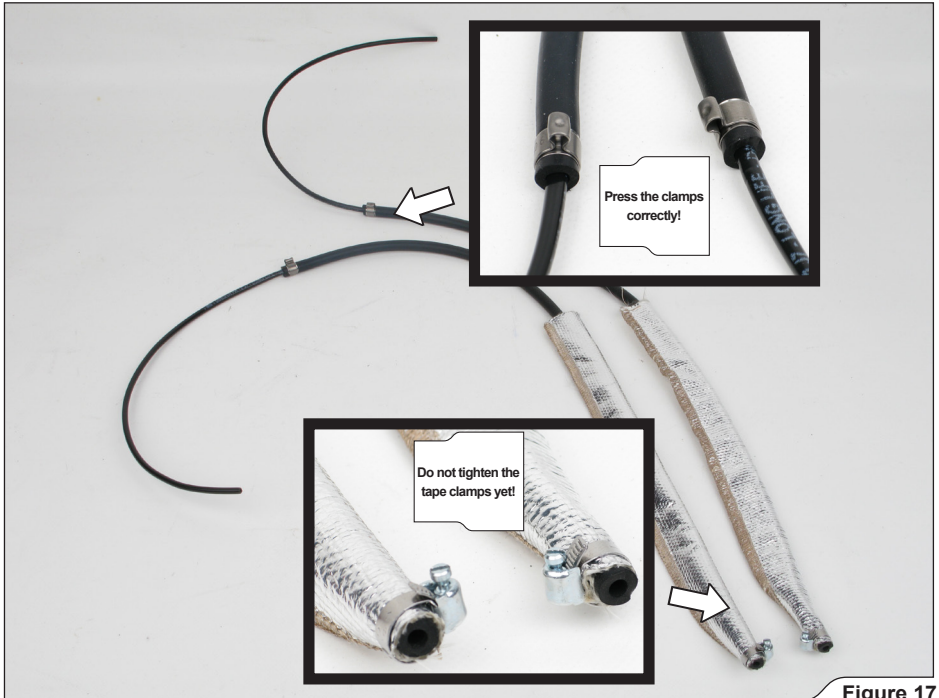

Figure 17

3. **For vehicles with non-sports original exhaust system only:** assemble the Akrapovič pvc vacuum tubes into the original rubber vacuum outlets and secure the connections, using tape clamps from Akrapovič installation kit (**Figure 18, 19**).

! **IMPORTANT:** do not overtighten the tape clamps!

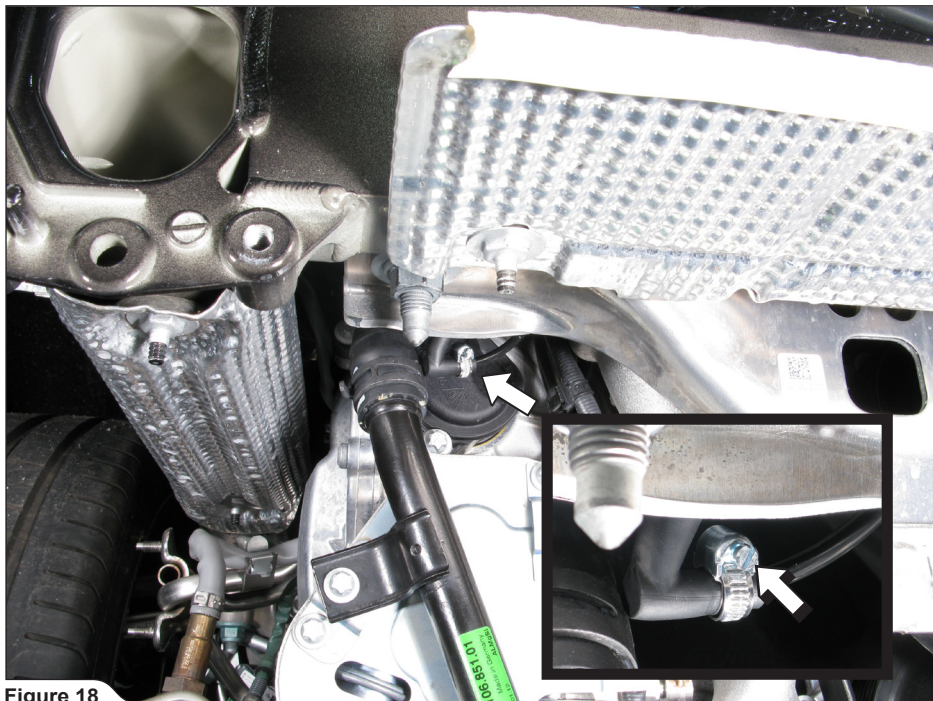

Figure 18

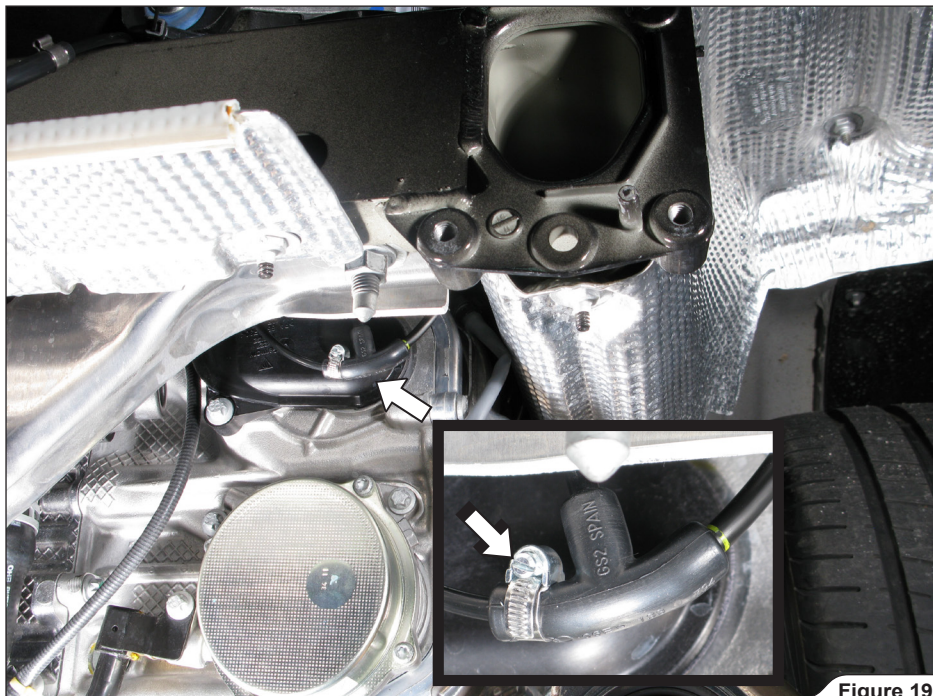

Figure 19

4. **For vehicles with non-sports original exhaust system only:** direct and secure the Akrapovič vacuum tubes, exactly as shown (Figure 20, 21).

! **IMPORTANT:** direct the vacuum tubes in such a way, that they don't touch any hot or moving parts!

! **IMPORTANT:** make sure, that vacuum tubes are not bent or obstruct in any way!

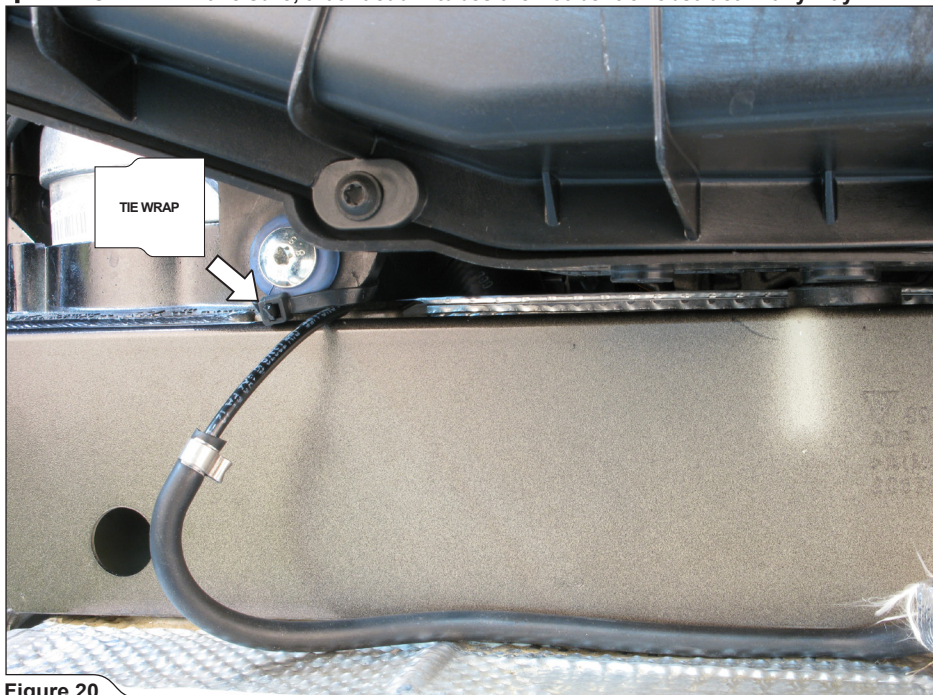

Figure 20



Figure 21

5. Correctly orient the central muffler's clamps and carefully slide them onto the muffler (Figure 22).

! **IMPORTANT:** use anti-seize copper paste on clamps' bolt and nut threads!

! **IMPORTANT:** do not screw the bolts into the clamps yet!

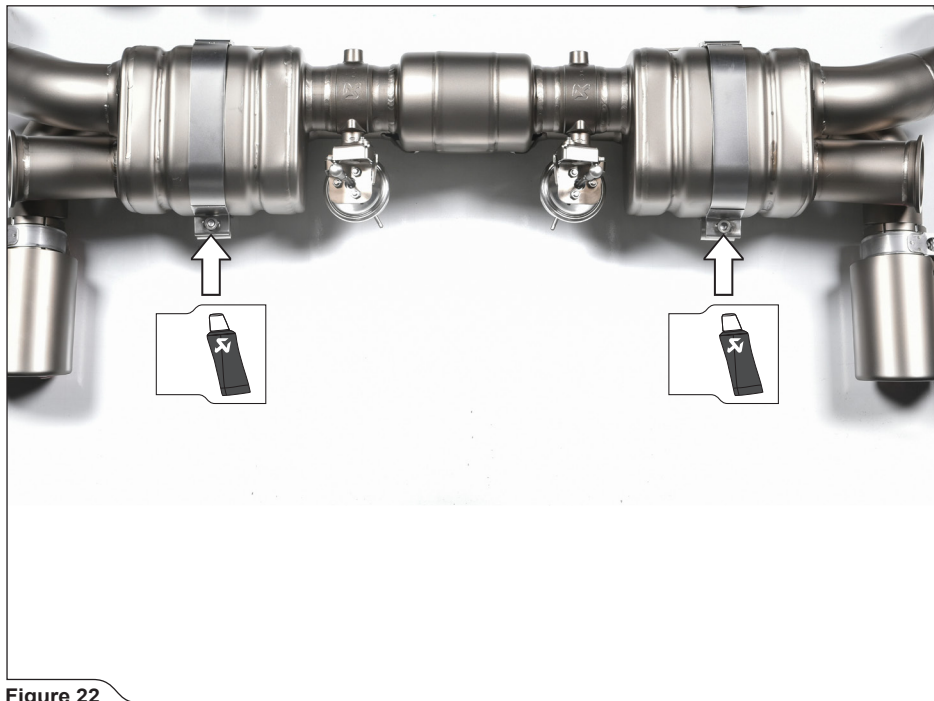

Figure 22

6. Hang the central muffler onto the bracket, as shown (Figure 23, 24).

! **IMPORTANT:** use new exhaust gaskets in Akrapovič muffler's inlet pipes - stock headers joints!

! **CAUTION:** make sure not to injure yourself, or damage any part of the vehicle during this procedure!

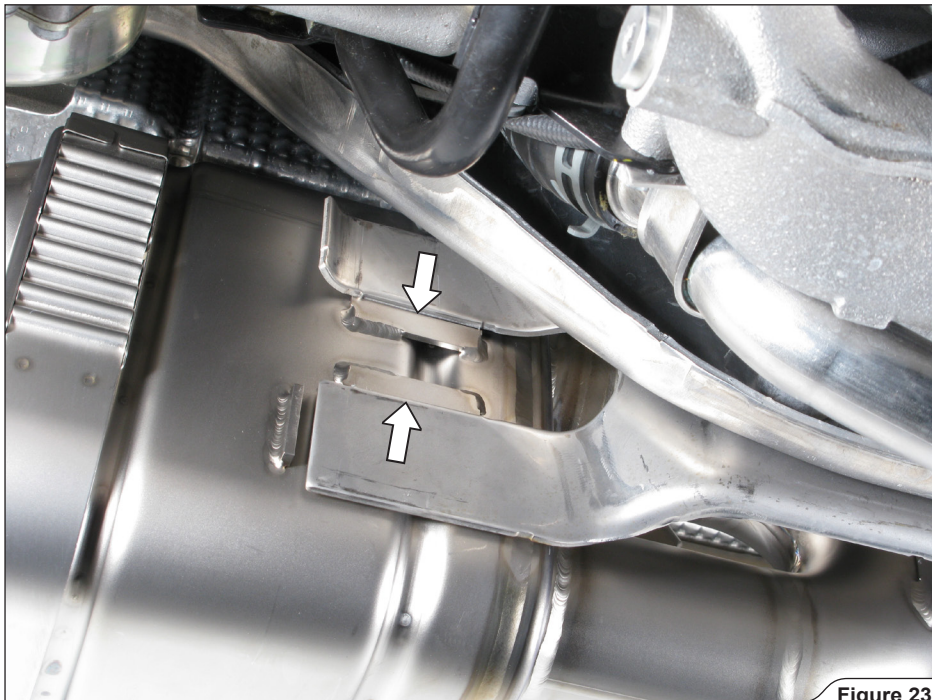

Figure 23

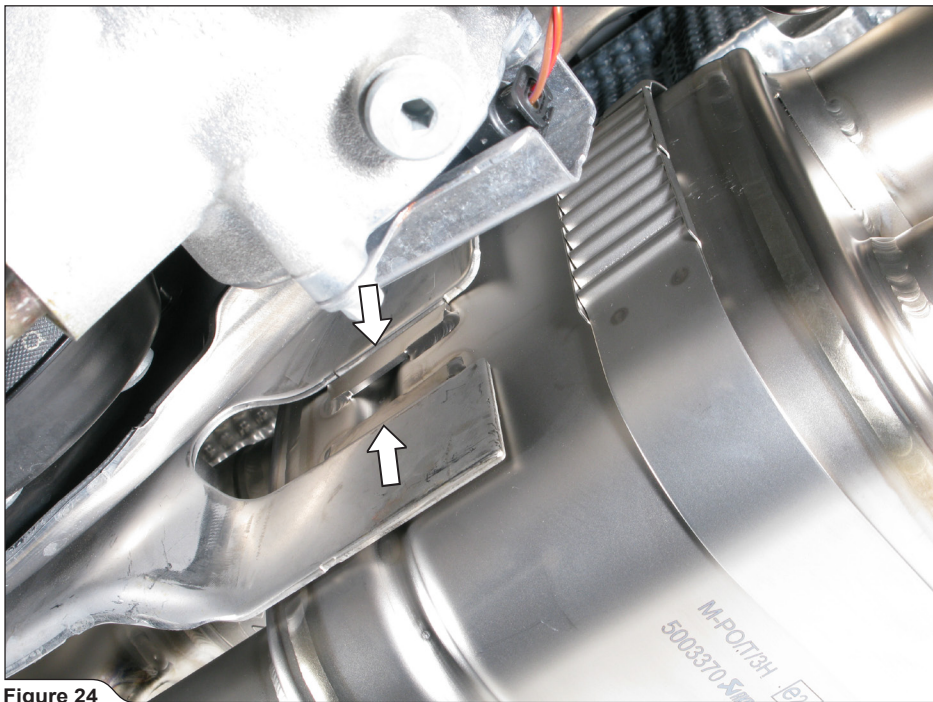

Figure 24

- Slide the clamps over the muffler's bracket, align the muffler in respect to the vehicle chassis and tighten the clamps to the specified torque (**Figure 25**).

! **IMPORTANT:** make sure to position the clamps over the original bracket correctly!

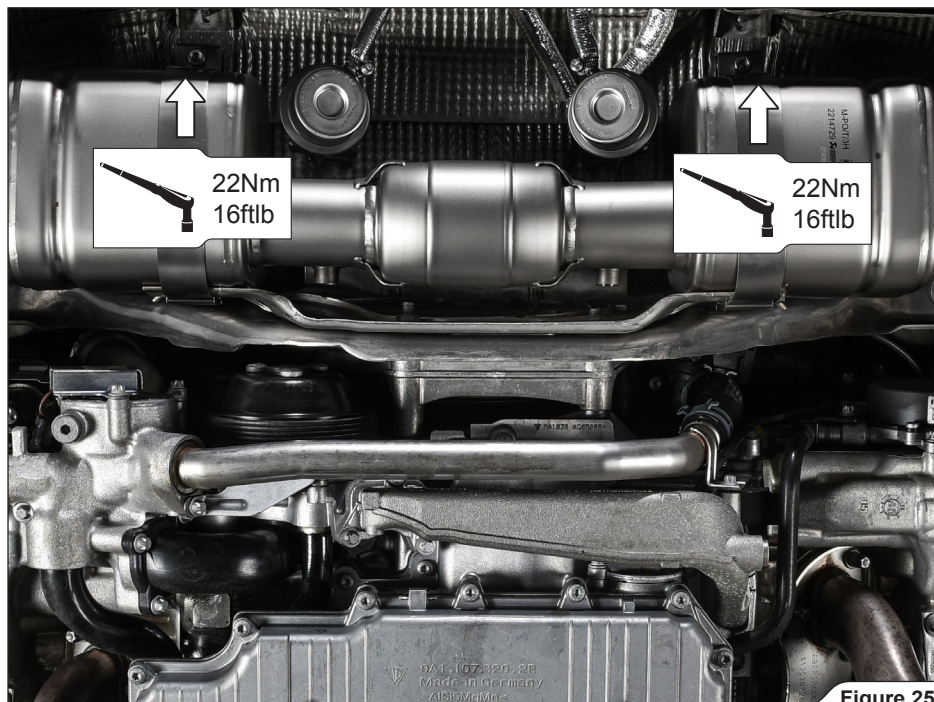

Figure 25

8. Hang both side mufflers onto the brackets and flanges; hand tighten the stock nuts (**Figure 26**).
! **IMPORTANT:** do not fully tighten the side mufflers' brackets and flange nuts yet!

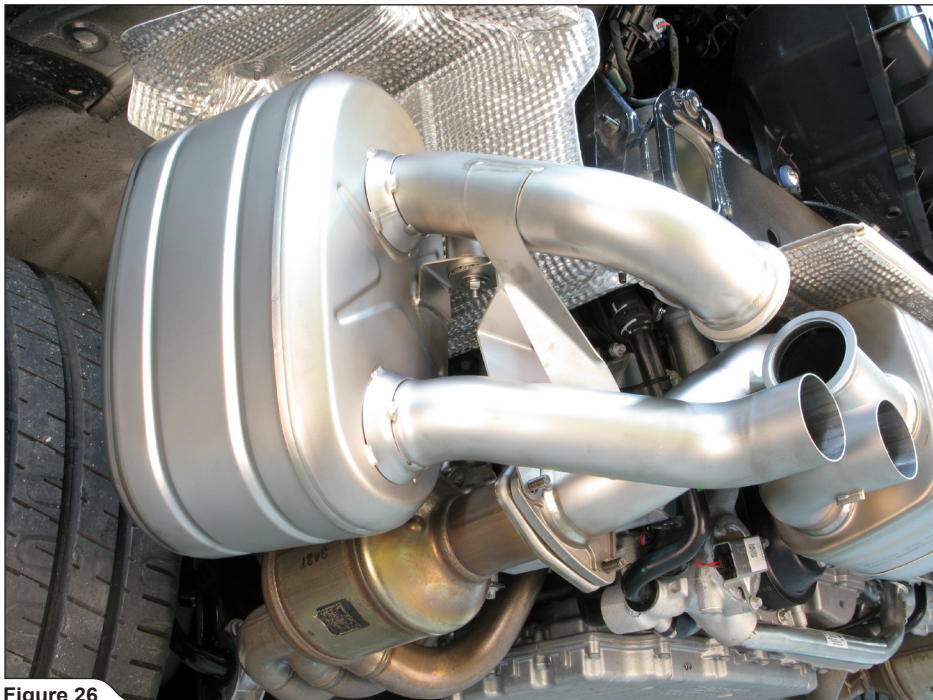

Figure 26

9. Insert the buffers correctly (**check the correct orientation of the marks!**), attach and orient the clamps exactly as shown and tighten the clamps to the specified torque (**Figure 27, 28**).

! **IMPORTANT:** use anti-seize copper paste on clamps' bolt and nut threads!

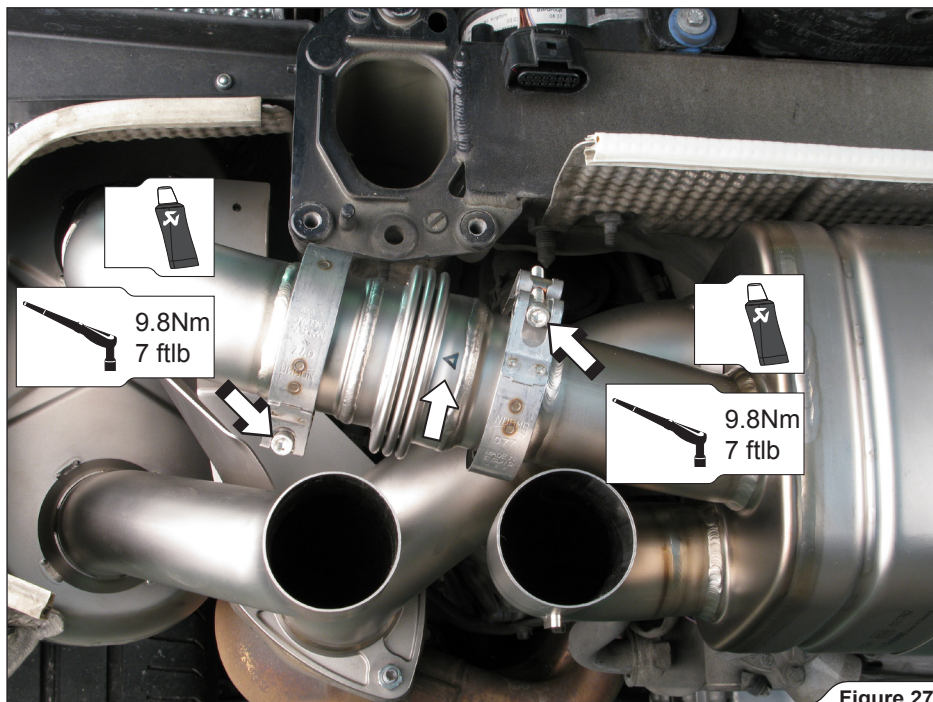

Figure 27

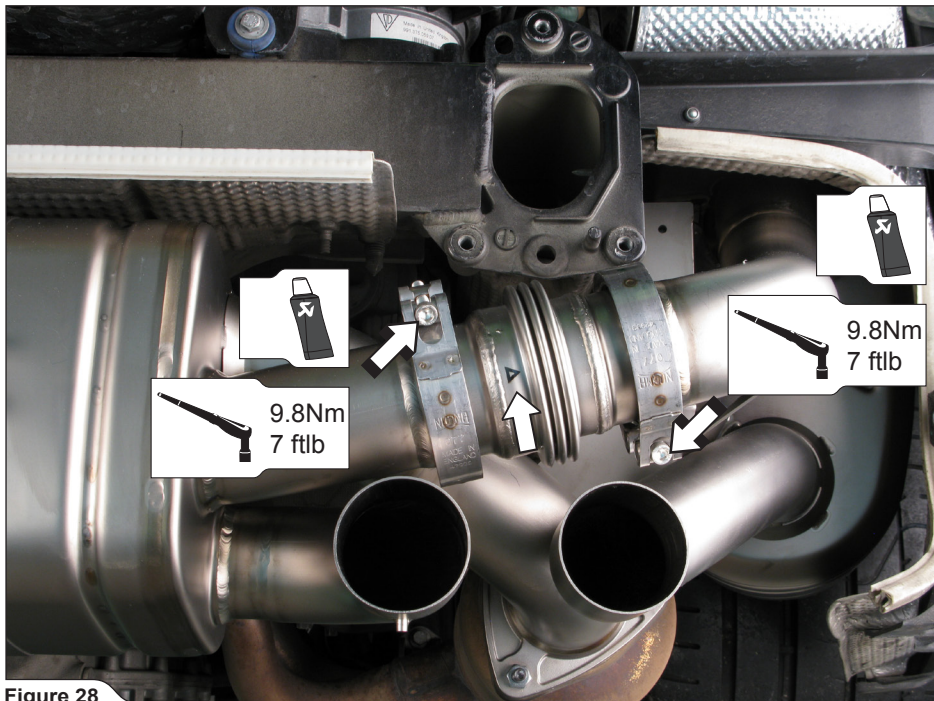

Figure 28

10. Tighten the central muffler's flanges and side mufflers brackets on both sides of the vehicle (Figure 29, 30).

! **IMPORTANT:** use anti-seize copper paste on all nut threads!

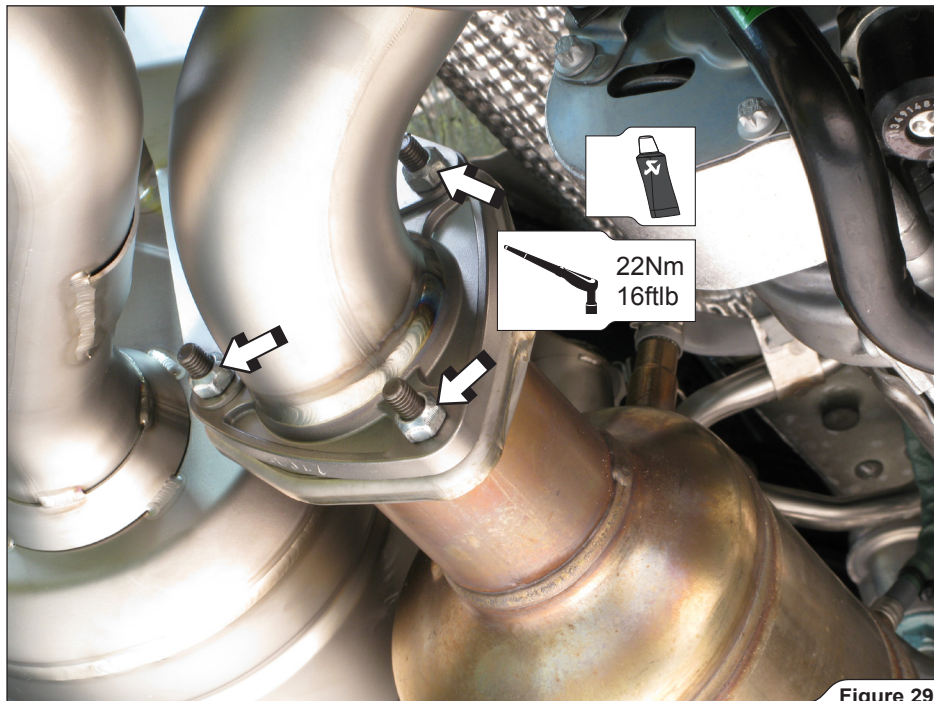

Figure 29

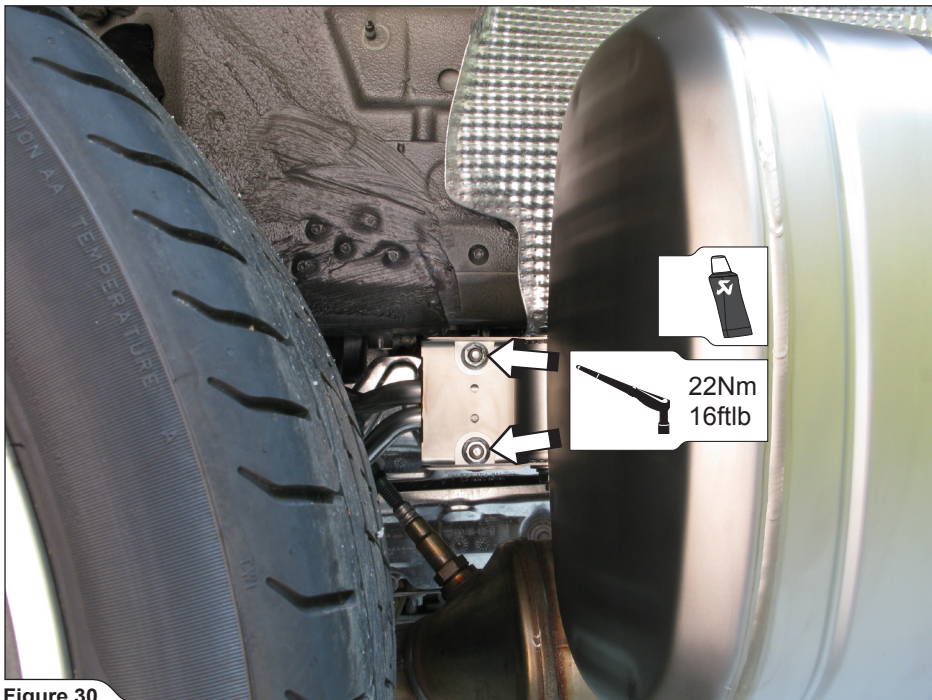

Figure 30

11. Retighten the header tubes' flange bolts on both sides of the engine (**Figure 31**).

! **IMPORTANT:** tighten the stock bolts to a specified torque using criss-cross pattern in three steps!

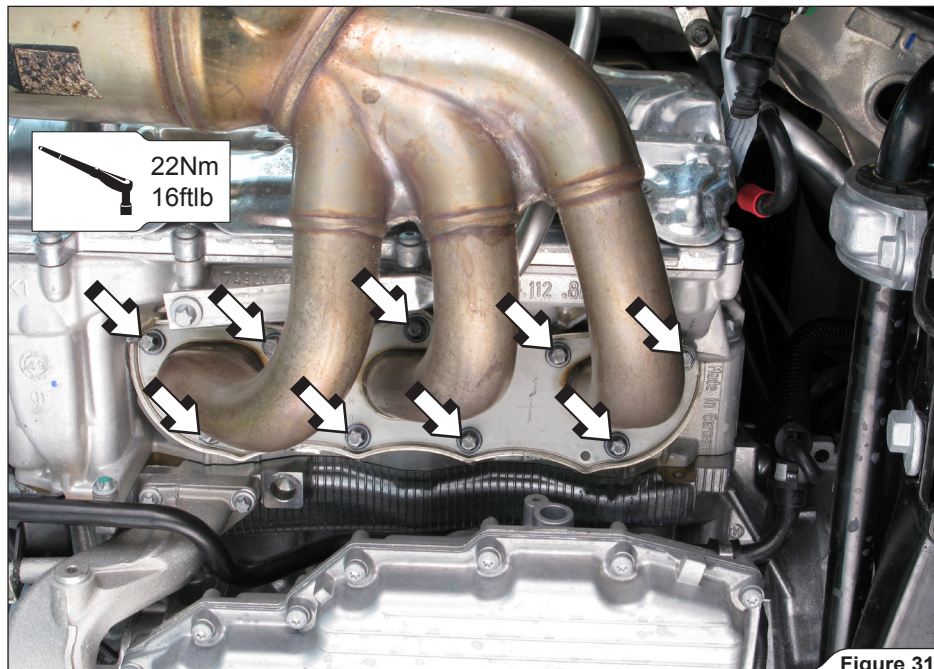

Figure 31

12. **For vehicles with sports original exhaust system only:** redirect the stock vacuum outlet tube as shown and bind it with the Akrapovič vacuum tubes; secure the connection using clamps from Akrapovič installation kit (**Figure 32**).

! **IMPORTANT:** direct the stock vacuum tube in such a way, that it doesn't touch any hot or moving parts!

! **IMPORTANT:** make sure, that stock vacuum tube is not bent or obstruct in any way!



Figure 32

13. Connect the vacuum tubes to the vacuum actuators and tighten the tape clamps (**Figure 33**).
! IMPORTANT: do not overtighten the tape clamps!

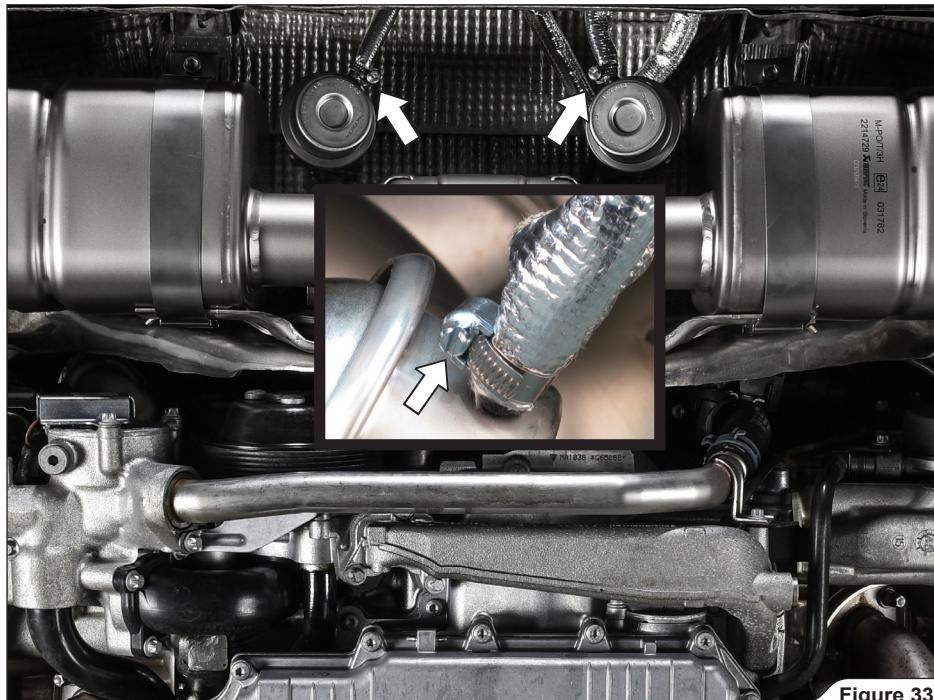

Figure 33

14. Reassemble the central muffler's heat shield; direct the vacuum tubes between the two heat shields, as shown (Figure 34, 35).

! **IMPORTANT:** make sure, that only heat protected part of the vacuum tubes extends into the inner side of the muffler's heat shield!

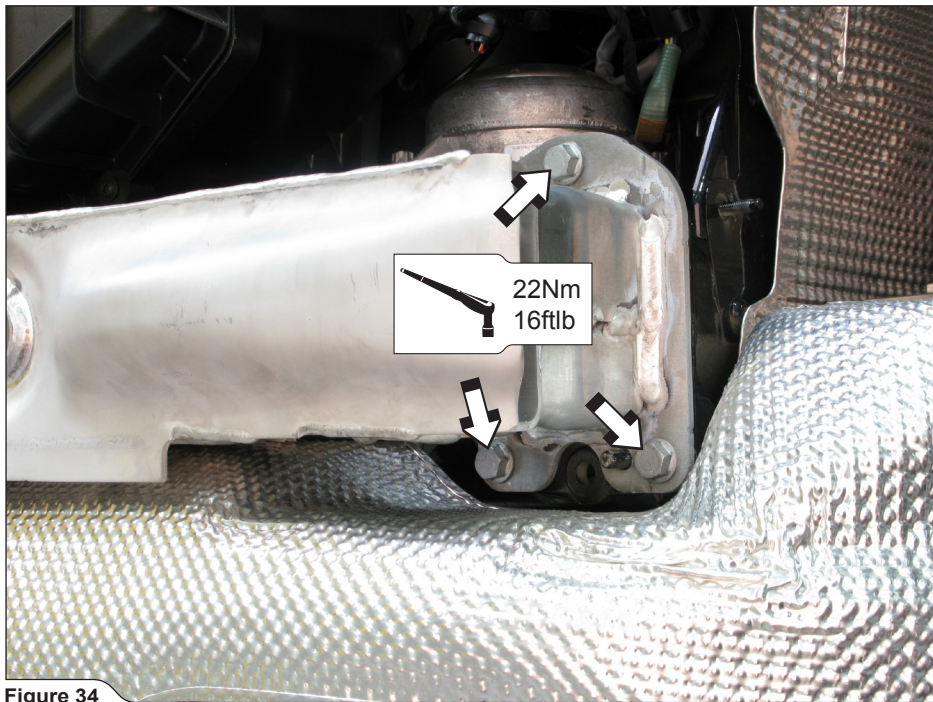

Figure 34

! IMPORTANT: make sure, that the vacuum tubes are not bent or obstruct in any way!

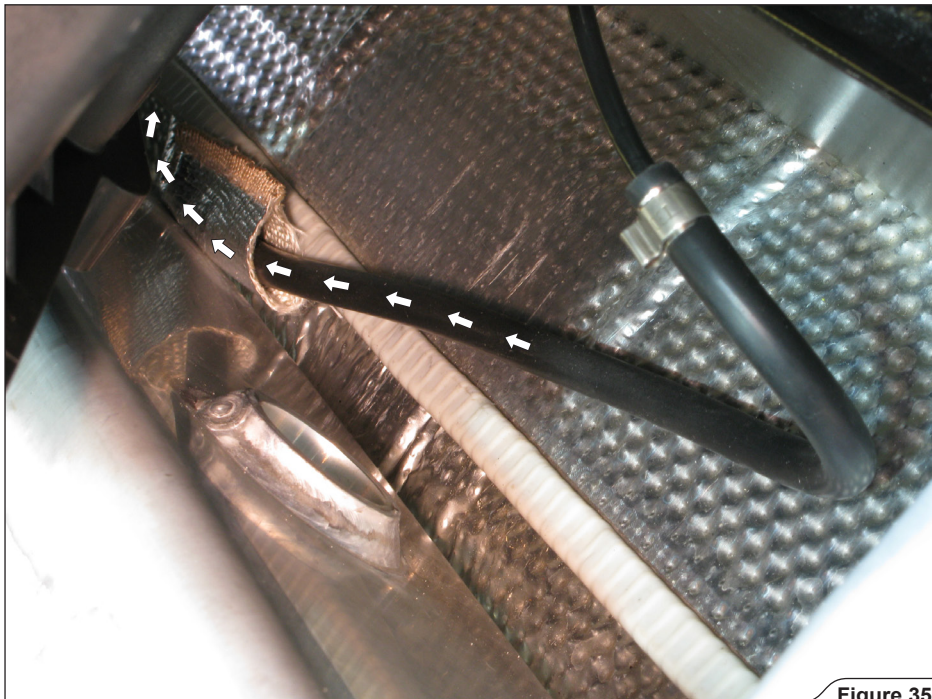

Figure 35

15. Replace all dismantled stock parts (heat shields, bumper, tail lights) in the reverse order from the order in which they were removed. Check vehicle manufacturer manual for tightening torques.

! **IMPORTANT: make sure, that you connect all disconnected electrical connectors!**

16. Assemble the clamps and spherical rings onto the tail pipes, as shown (Figure 36).

! **IMPORTANT: use anti-seize copper paste on all clamp bolt threads!**



Figure 36

- Slide the tail-pipes onto the muffler outlets. Rotate and center them in respect to rear bumper and according to your personal taste (**Figure 37**).

! **IMPORTANT:** make sure, not to damage tail pipes, bumper or any part of the vehicle during this procedure!



Figure 37

18. Tighten tail pipe clamps to the specified torque on both sides of the vehicle (**Figure 38**).

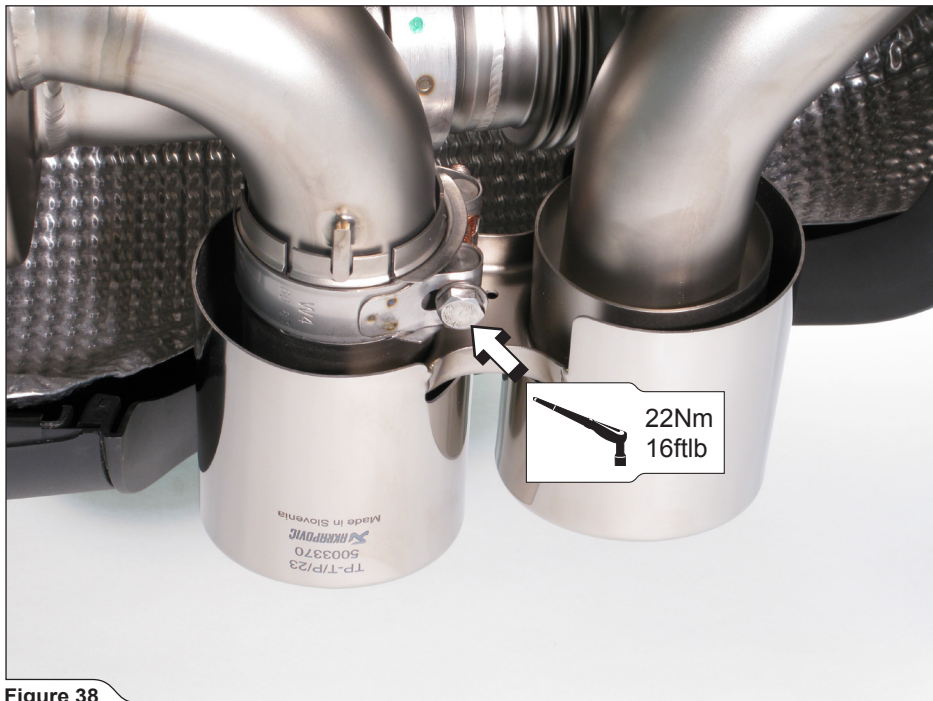

Figure 38

FINAL INSTALLATION:

- ! **IMPORTANT:** reinstall the dismantled or partially removed stock parts (wheel arches, bumper etc.); check vehicle manufacturer manual for tightening torques.
- ! **IMPORTANT:** make sure all the nuts and bolts are sufficiently tightened. In case the exhaust system touches the cowl or other parts, repeat the adjustment of the exhaust system or contact your authorized dealer.
- ! **IMPORTANT:** clean all exhaust components before the first start of the engine or the stains will burn onto the surfaces!

MAINTENANCE OF THE AKRAPOVIČ EXHAUST SYSTEM:

1. Clean the titanium exhaust components with a multi-purpose spray lubricant (WD-40® or equivalent)*, carbon fiber exhaust components with soft and dry cloth and stainless steel components with soft cloth sprayed with contact cleaner, then wipe with soft and dry cloth. A change in the color of the exhaust system is normal due to high temperatures.
2. Periodically make sure all the bolts and springs are sufficiently tight.
*WD-40® is a trademark of the WD-40 Company.

⚡ INSTALLATION TIP: IT IS NORMAL FOR WHITE SMOKE TO COME OUT OF THE MUFFLER AT FIRST OPERATION.

- ! **CAUTION: DO NOT STAND BEHIND THE MUFFLER AT ANY TIME.**
- ! **CAUTION: DO NOT USE AUTOMOTIVE WHEEL CLEANERS OR ANY CLEANING PRODUCTS WHICH CONTAIN ACIDIC ADDITIVES TO CLEAN THE AKRAPOVIČ EXHAUST SYSTEMS.**

WARNING: THE EXHAUST SYSTEM CAN BE EXTREMELY HOT. ALLOW THE EXHAUST AND ENGINE TO COOL DOWN BEFORE BEGINNING INSTALLATION OR ANY OTHER WORK ON THE EXHAUST SYSTEM. THIS MANUAL IS SPECIFIC TO THE PORSCHE 911 CARRERA S. THERE MAY BE SOME DIFFERENCES IN INSTALLATION PROCEDURES FOR OTHER MODELS.

TROUBLESHOOTING:

Problem	Possible cause	Solution
Exhaust gas leaks out of the muffler/pipe clamp connections	loosened clamp	tighten the clamp to specified torque
	connection is not completely joined	tap the connection into place and tighten the clamp to specified torque
Valves are not moving	No supply	Check green LED on the Control Kit. If the LED is off: <ul style="list-style-type: none">• Check electrical connection and connectors• Check fuse for exhaust valves (in the trunk, right)
	Error detected	Check green LED on the Control Kit. If the LED is blinking fast: <ul style="list-style-type: none">• Check electrical connections and connectors• Try to use the Sound Kit remote controller. If valves are turning, then check how the Communication sensor is installed

www.akrapovic.com

