



INTAKE SYSTEMS FOR VEHICLES LISTED ARE 50 STATE LEGAL. SEE KNFILTERS.COM FOR CARB STATUS ON EACH PART FOR A SPECIFIC VEHICLE.

# INSTALLATION INSTRUCTIONS

**57-2584**  
**FORD**  
**2011-12 F150**  
**V8-6.2L**

**NOTE:** This kit was not designed to fit vehicles with a body lift.

**TOOLS NEEDED:**

- Ratchet
- Extension
- 10mm socket
- flat blade screw driver
- 3/4" wrench
- 9/16" wrench
- 4mm Allen wrench
- 3mm Allen wrench
- T20 Torx

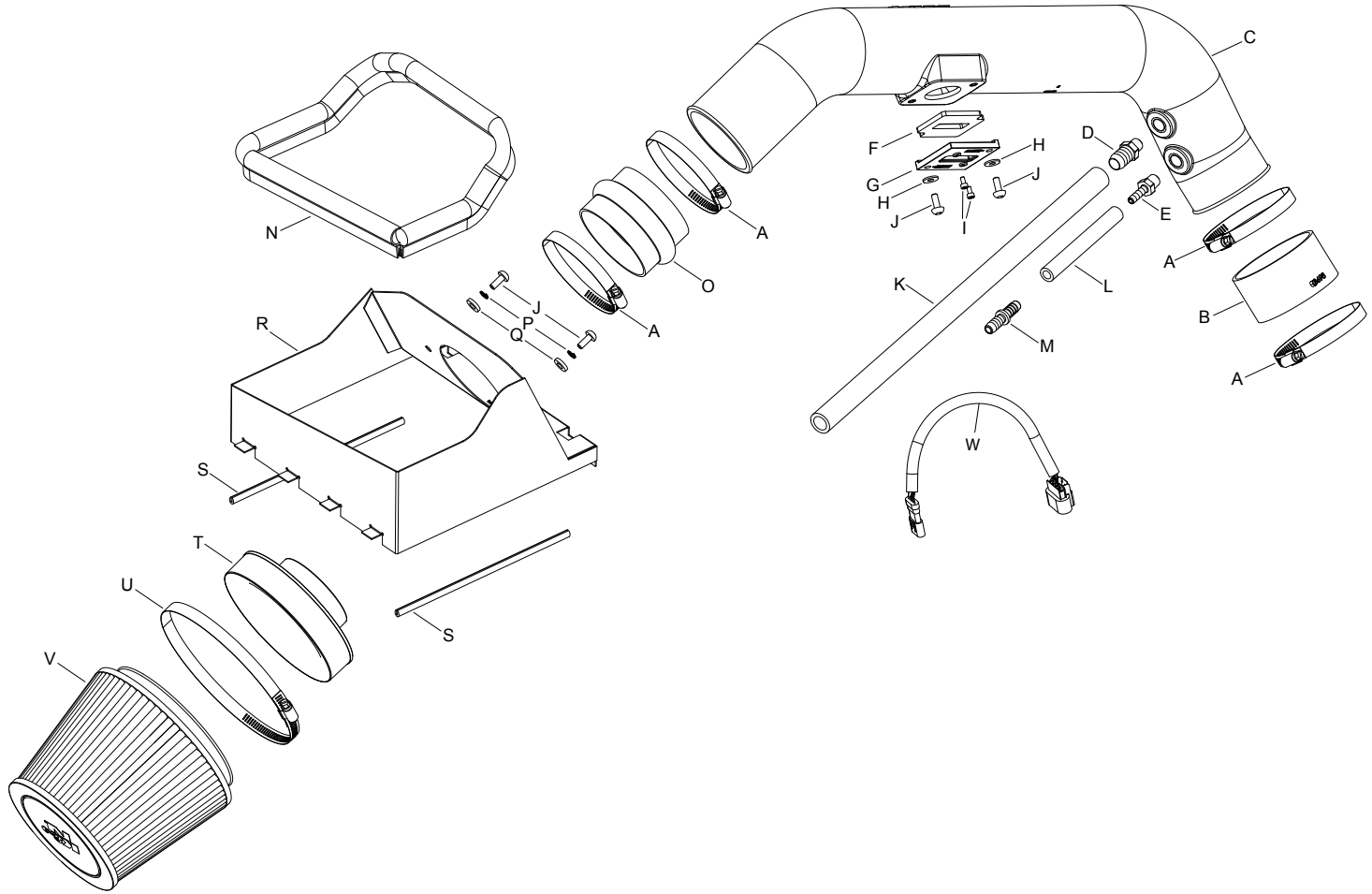

**PARTS LIST:**

| Description                              | Qty. | Part # | Description                                  | Qty. | Part #  |
|--|------|--------|--|------|---------|
| A Hose Clamp #56                         | 4    | 08620  | L Hose; 3/8" ID X 5"L                        | 1    | 08717   |
| B Hose; 3-1/2"ID X 2"L Reinforced        | 1    | 08698  | M Vent; STRT 3/8" Hose- 3/8"Hose             | 1    | 08041   |
| C Intake tube (IT)                       | 1    | 087262 | N Edge Trim (35")                            | 1    | 102471  |
| D Vent; STRT, 5/8" Barbed 1/4 NPT, Nylon | 1    | 08911  | O Hose; 3-1/2"ID X 2-1/2"L Hump Reinforced   | 1    | 08699   |
| E Vent; STRT, 3/8" HOSE, 1/4" NPT, PLAS  | 1    | 08047  | P Washer; M6 Split Lock Zinc                 | 2    | 1-3025  |
| F Gasket; 57-2556, 3-16 Poron            | 1    | 09069  | Q Washer; 1/4"ID X 5/8"OD -SAE               | 2    | 08275   |
| G Adaptor; #420, Nylon 6/6 GF, Black     | 1    | 21515  | R Heat Shield                                | 1    | 074076  |
| H Washer; 6MM Flat, SS                   | 2    | 08269  | S Edge Trim (19")                            | 1    | 102451  |
| I Bolt; M4-0.07 8MM, A/H Cap, SS         | 2    | 07733  | T Adapter; Universal, 6" Filter 3.5" Coupler | 1    | 21512-1 |
| J Bolt; M6 X 1.00 X 16MM, Buttonhead, SS | 4    | 07730  | U Hose Clamp #104                            | 1    | 08697   |
| K Hose 5/8"ID X 20"L                     | 1    | 08542  | V Air Filter                                 | 1    | RC-5173 |
|  |      |        | W Extension Harness                          | 1    | 21780   |

**NOTE: FAILURE TO FOLLOW INSTALLATION INSTRUCTIONS AND NOT USING THE PROVIDED HARDWARE MAY DAMAGE THE INTAKE TUBE, THROTTLE BODY AND ENGINE.**

**TO START:**

1. Turn off the ignition and disconnect the negative battery cable.  
**NOTE: Disconnecting the negative battery cable erases pre-programmed electronic memories. Write down all memory settings before disconnecting the negative battery cable. Some radios will require an anti-theft code to be entered after the battery is reconnected. The anti-theft code is typically supplied with your owner's manual. In the event your vehicles' anti-theft code cannot be recovered, contact an authorized dealership to obtain your vehicles anti-theft code.**

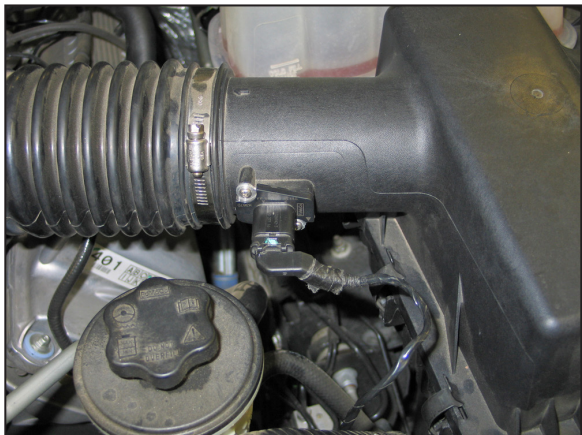

2. Disconnect the mass air sensor electrical connection.



3. Loosen the hose clamp that secures the intake tube to the intake plenum.

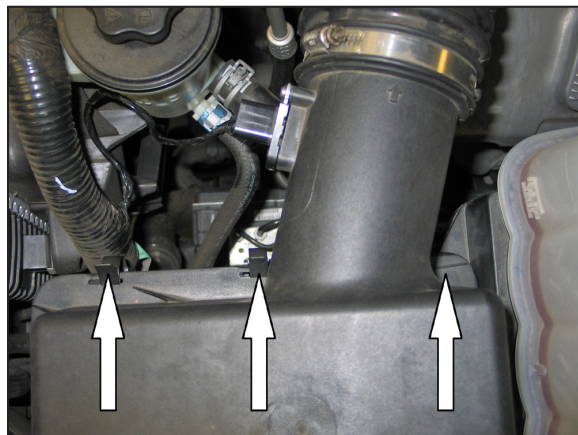

4. Release the three upper air box retaining clips.



5. Remove the upper air box/intake hose assembly and air filter.  
**NOTE: K&N Engineering, Inc., recommends that customers do not discard factory air intake.**

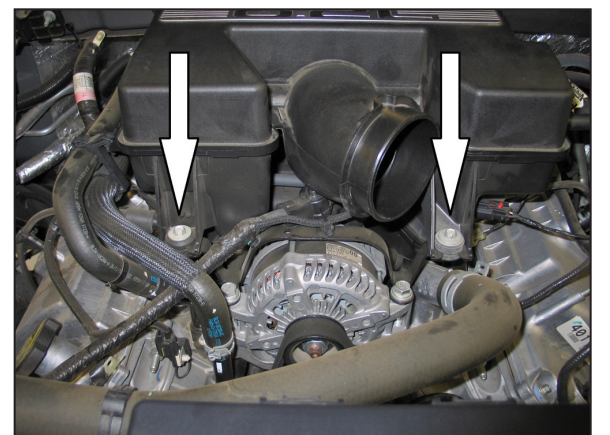

6. Remove the two bolts securing the intake plenum onto the intake manifold.

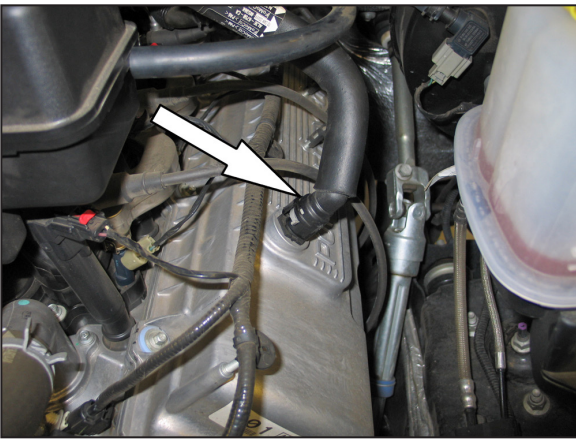

7. Disconnect the crank case vent tube from the valve cover port.



8. Disconnect the EVAP vent line from the intake plenum.



9. Loosen the hose clamp securing the intake plenum to the throttle body and then remove the intake plenum from the vehicle.

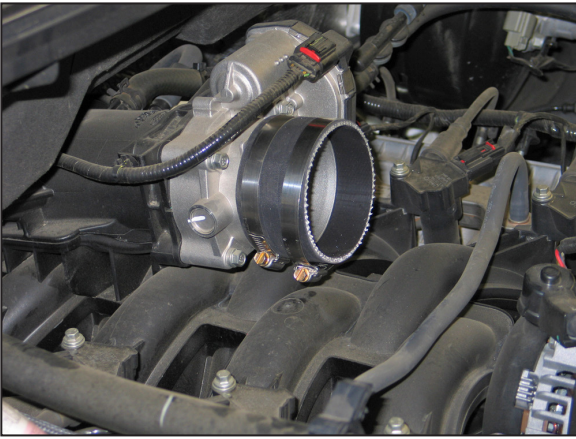

10. Install the provided silicone hose (08698) onto the throttle body and secure with the provided hose clamp.

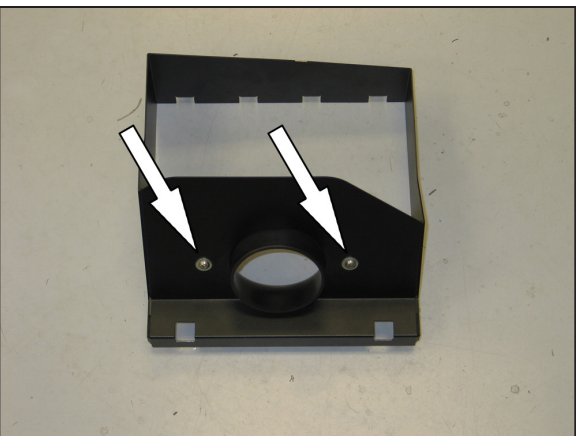

11. Install the K&N® filter adapter into the heat shield as shown and secure with the provided hardware.

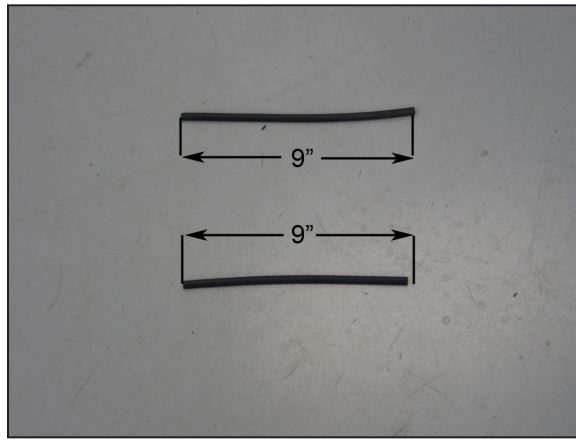

12. Cut the provided edge trim into two 9" sections as shown.

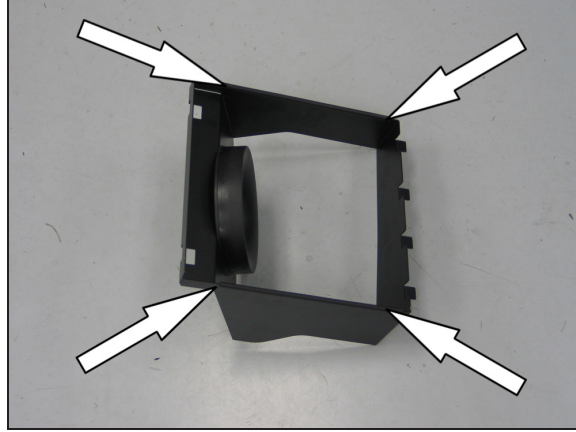

13. Install the cut edge trim onto the bottom of the heat shield as shown.

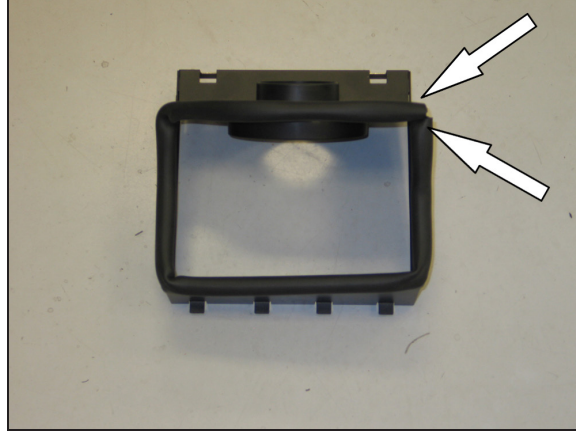

14. Install the provided "Top bulb" edge trim onto the top off the heat shield as shown.  
**NOTE: Some trimming of the edge trim will be necessary.**

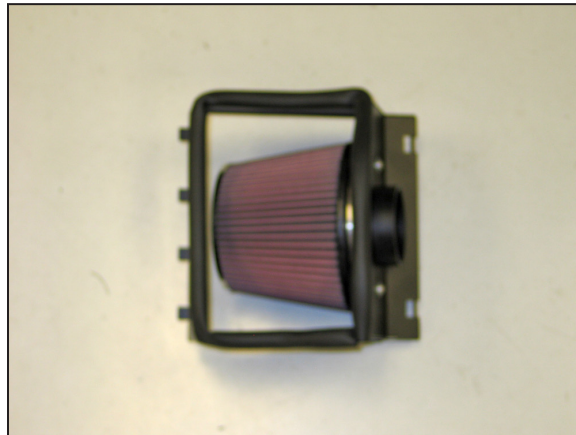

15. Install the K&N® air filter onto the filter adapter and secure with the provided hose clamp.  
**NOTE: Drycharger® air filter wrap; part # RC-5173DK is available to purchase separately. To learn more about Drycharger® filter wraps or look up color availability please visit <http://www.knfilters.com>®.**

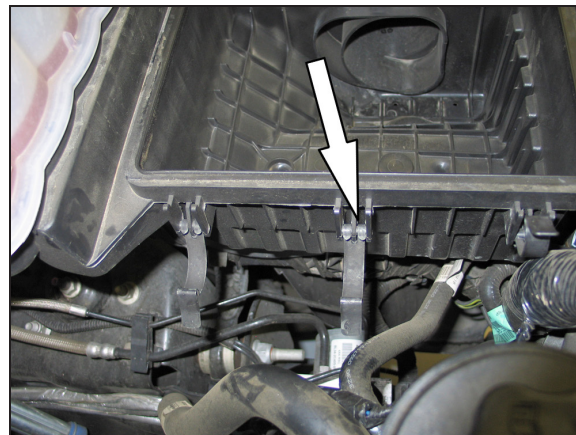

16. Remove the middle upper air box retaining clip from the lower air box.

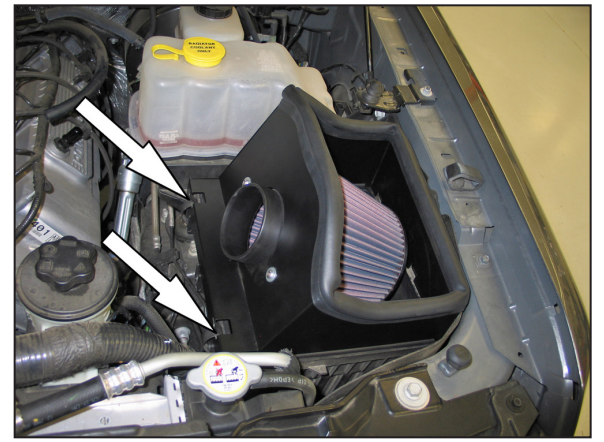

17. Set the heat shield assembly into the lower air box and secure with the two factory air box retaining clips.



18. Install the provided silicone hump hose (08699) onto the filter adapter and secure with the provided hose clamps.

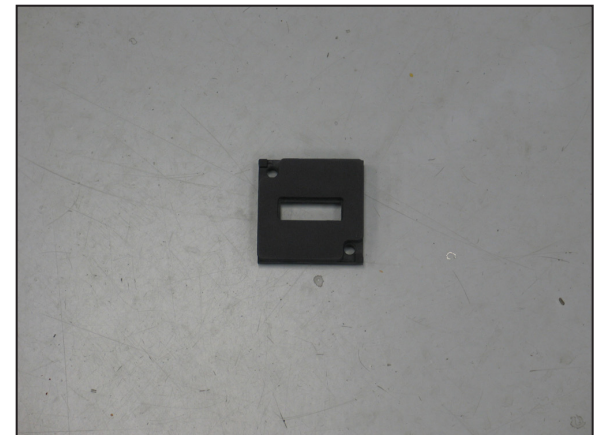

19. Install the provided gasket onto the mass air sensor adapter.



20. Remove the two screws securing the mass air sensor into the factory air box and then remove the mass air sensor from the air box.



21. Install the mass air sensor into the K&N® mass air sensor adapter and secure with the provided hardware.

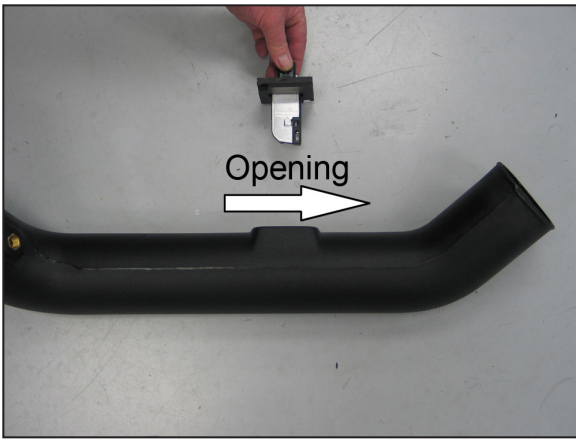

22. Install the mass air sensor assembly into the K&N® intake tube as shown and secure with the provided hardware.  
**NOTE: The opening of the mass air sensor is to be towards the filter end of the intake tube.**



23. Install the provided vent fittings into the K&N® intake tube as shown.  
**NOTE: Plastic NPT fittings are easy to cross thread. Install the vent fitting "hand" tight, then turn it two complete turns with a wrench.**



24. Install K&N® intake tube into the silicone hose at the filter adapter and then into the hose at the throttle body, adjust the hose for proper fit and then secure with the provided hose clamps.

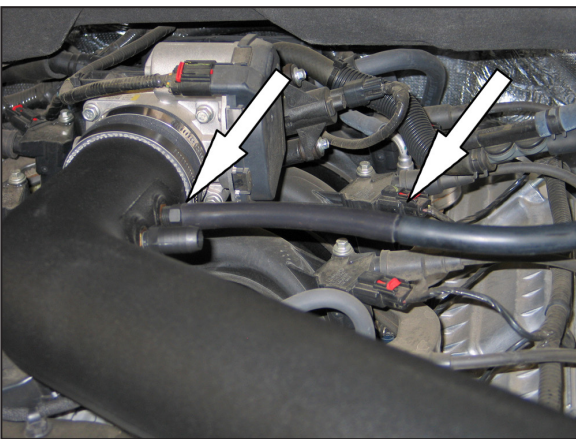

25. Install the hose mender into the provided EVAP hose, then install the hose mender into the factory EVAP hose and attach the open end onto the vent fitting installed into the K&N® intake tube.

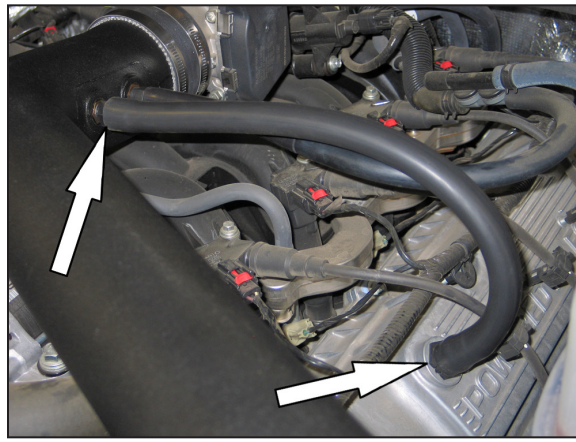

26. Install the provided crank case vent hose onto the valve cover port and then onto the vent installed into the K&N® intake tube as shown.

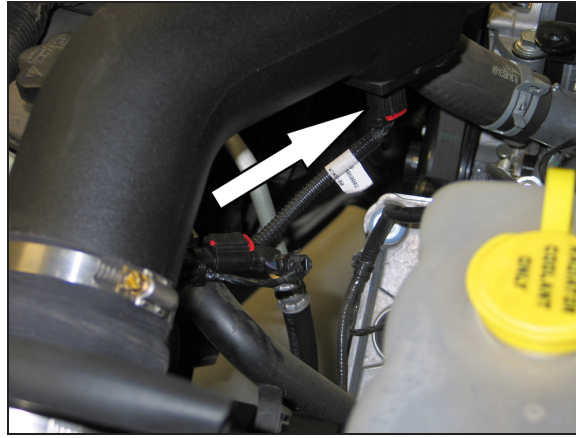

27. Connect the provided mass air sensor extension harness into the factory harness and then connect to the mass air sensor, secure the wiring harness with the provided tie wrap.



28. Reconnect the vehicle's negative battery cable. Double check to make sure everything is tight and properly positioned before starting the vehicle.

29. The C.A.R.B. exemption sticker, (attached), must be visible under the hood so that an emissions inspector can see it when the vehicle is required to be tested for emissions. California requires testing every two years, other states may vary.

30. It will be necessary for all K&N® high flow intake systems to be checked periodically for realignment, clearance and tightening of all connections. Failure to follow the above instructions or proper maintenance may void warranty.

#### ROAD TESTING:

1. Start the engine with the transmission in neutral or park, and the parking brake engaged. Listen for air leaks or odd noises. For air leaks secure hoses and connections. For odd noises, find cause and repair before proceeding. This kit will function identically to the factory system except for being louder and much more responsive.

2. Test drive the vehicle. Listen for odd noises or rattles and fix as necessary.

3. If road test is fine, you can now enjoy the added power and performance from your kit.

4. K&N Engineering, Inc., requires cleaning the intake system's air filter element every 100,000 miles. When used in dusty or off-road environments, our filters will require cleaning more often. We recommend that you visually inspect your filter once every 25,000 miles to determine if the screen is still visible. When the screen is no longer visible some place on the filter element, it is time to clean it. To clean and re-oil, purchase our filter Recharger® service kit, part number 99-5050 or 99-5000 and follow the easy instructions.

**INTAKE SYSTEMS FOR VEHICLES LISTED ARE 50 STATE LEGAL. SEE KNFILTERS.COM FOR CARB STATUS ON EACH PART FOR A SPECIFIC VEHICLE.**